

N20001

EVOS STANDARD

A + B

- Ⓛ Istruzioni di montaggio
- Ⓔ Fitting instructions
- Ⓕ Instructions de montage
- Ⓓ Montageanleitung
- Ⓔ Instrucciones de montaje
- ⒫ Instruções de montagem
- Ⓓ Montage-instructies
- Ⓔ Monteringsanvisning
- Ⓕ Asennusohje
- Ⓔ Paigaldusjuhend
- Ⓕ Stiprināšanas instrukcija
- Ⓕ Pritvirtinimo instrukcijos
- Ⓕ Instrukcja montażu
- Ⓕ Инструкции по установке
- Ⓕ Návod na montáž
- Ⓕ Návod na montáž
- Ⓕ Navodila za pritrjevanje
- Ⓕ Uputa za sastavljanje
- Ⓕ A felszerelés módja
- Ⓕ Οδηγίες συναρμολόγησης
- Ⓕ Montaj talimatları
- Ⓕ Инструкции за монтаж
- Ⓕ Uputstva za montažu

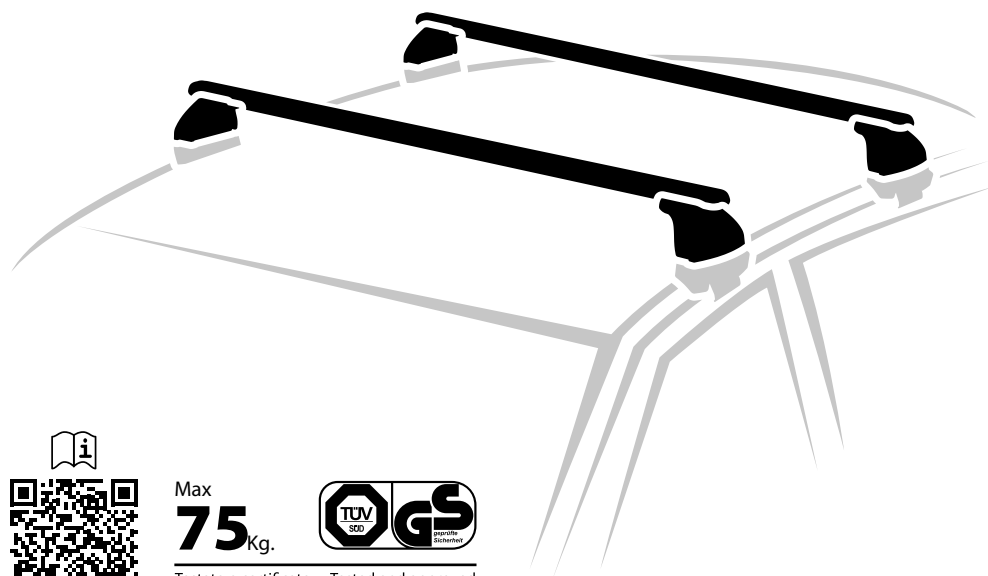

Max
75 Kg.



Testato e certificato • Tested and approved
Geprüft und zertifiziert

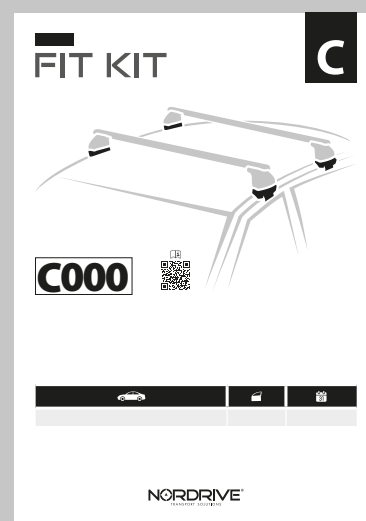



Safety Regulations

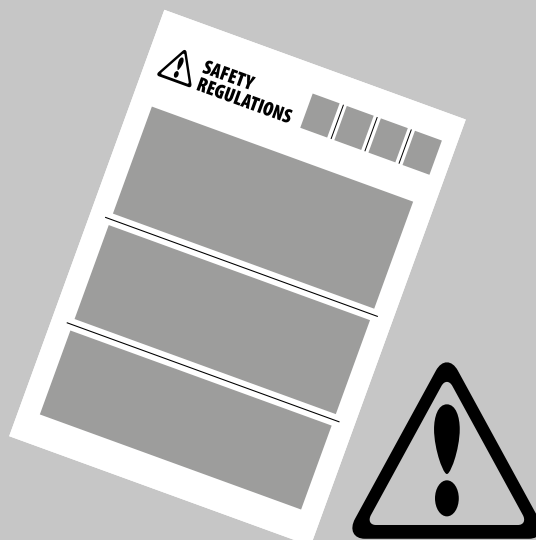
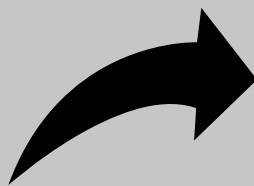

- I** Leggere il libretto di sicurezza e garanzia incluso nel prodotto prima dell'uso. Per maggiori informazioni visita il sito **www.nordrive.it** o contattare direttamente il rivenditore locale.
- EN** Before using this product, please read the enclosed safety and warranty booklet. For more information please visit **www.nordrive.it** or contact your local dealer.
- F** Avant d'utiliser ce produit, veuillez lire le livret de sécurité et de garantie inclus. Pour plus d'informations, visitez le site **www.nordrive.it** ou contactez votre revendeur local.
- D** Bevor die Verwendung des Produkts, die Sicherheitsbrochüre und Garantieheft lesen. Für weitere Informationen empfehlen wir Ihnen die Webseite **www.nordrive.it** zu besuchen oder direkt den örtlichen Wiederkäufer zu kontaktieren.
- E** Antes de usar este producto, lea el folleto de seguridad y garantía incluido. Para obtener más información, visite **www.nordrive.it** o póngase en contacto con su distribuidor local.
- P** Antes de usar este produto, por favor leia o livro de segurança e garantia incluso. Para obter mais informações, visite **www.nordrive.it** ou entre em contato com seu revendedor local.
- NL** Lees voor het gebruik van dit product het bijgevoegde veiligheids- en garantieboekje. Ga voor meer informatie naar **www.nordrive.it** neem contact op met uw lokale dealer.
- S** Före användning av denna produkt, vänligen läs den medföljande broschyren om säkerhet och garantivillkor. För mer information vänligen besök **www.nordrive.it** eller kontakta er lokala återförsäljare.
- FIN** Ennen kuin käytät tätä tuotetta, lue mukana toimitettu turva- ja takuukirja. Lisätietoja on osoitteessa **www.nordrive.it** tai ota yhteys paikalliseen jälleenmyyjään.
- EST** Enne toote kasutamist tutvuge kaasasoleva ohutus- ja garantiijuhendiga. Lisateabe saamiseks külastage veebisaiti **www.nordrive.it** või pöörduge kohaliku edasimüüja poole.
- LAT** Pirms šī produkta izmantošanas, lūdzu, izlasiet pievienoto drošības un garantijas bukletu. Lai iegūtu vairāk informācijas, lūdzu, apmeklējiet vietni **www.nordrive.it** vai sazinieties ar vietējo izplatītāju.
- LT** Prieš pradėdant naudoti šį produktą, prašome perskaityti pridėtus saugos ir garantinius lapus. Daugiau informacijos rasite apsilankę **www.nordrive.it** arba tiesiogiai susisiekdami su mūsų vietiniu atstovu.
- PL** Przed użyciem tego produktu prosimy o zapoznanie się z załączoną książeczką bezpieczeństwa i gwarancji. Aby uzyskać więcej informacji, odwiedź **www.nordrive.it** lub skontaktuj się z lokalnym sprzedawcą.
- RUS** Перед использованием продукта ознакомьтесь с буклетом по технике безопасности и гарантией. Для получения дополнительной информации рекомендуем посетить сайт **www.nordrive.it** или обратиться непосредственно к местному дилеру.
- CZ** Před použitím produktu si přečtěte přiloženou bezpečnostní a záruční brožuru. Další informace najdete na **www.nordrive.it** nebo přímo u místního prodejce.
- SK** Pred použitím produktu, prosím naštudujte najprv priložený manuál a bezpečnostné pokyny. Pre viac informácií prosím navštívte **www.nordrive.it** alebo kontaktujte miestneho predajcu/ zástupcu.
- SLO** Pred uporabo proizvoda preberi priložena navodila in garancijsko izjavo. Za več informacij obiščite internetno stran **www.nordrive.it** ali kontaktirajte lokalnega prodajalca.
- HR** Prije uporabe ovog proizvoda, pročitajte priloženo uputstvo o sigurnosti i jamstvu. Za više informacija posjetite **www.nordrive.it** ili kontaktirajte svog lokalnog distributera.
- H** Használat előtt kérjük figyelmesen olvassa el a biztonsági és garanciális útmutatót. Több információért kérjük keresse fel a **www.nordrive.it** weboldalt vagy lépjen kapcsolatba a honi forgalmazóval.
- GR** Πριν χρησιμοποιήσετε το προϊόν, παρακαλούμε διαβάστε το φυλλάδιο ασφάλειας και εγγύησης. Για περισσότερες πληροφορίες, επισκεφθείτε το **www.nordrive.it** ή επικοινωνήστε με τον τοπικό σας αντιπρόσωπο.
- TR** Bu ürünü kullanmadan önce lütfen ekteki güvenli ve garanti kitapçığını okuyun. Daha fazla bilgi için lütfen **www.nordrive.it** adresini ziyaret edin veya yerel bayinizle iletişime geçin.
- BG** Моля преди да използвате този продукт, прочетете инструкциите за безопасност и книжката с гаранционните условия. За повече информация моля посетете **www.nordrive.it** или се свържете с местния дистрибутор.
- SRB** Pre upotrebe ovog proizvoda, pažljivo pročitajte priloženu knjižicu o bezbednosti i garanciji. Za više informacija, molimo vas posetite **www.nordrive.it** ili kontaktirajte lokalnog distributera.

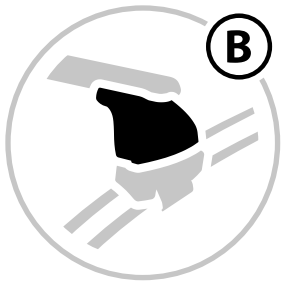

B

N20001 FEET

Contenuto • Content • Contenu • Inhalt • Contenido

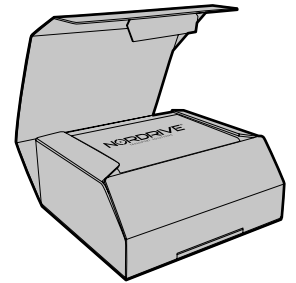

x4

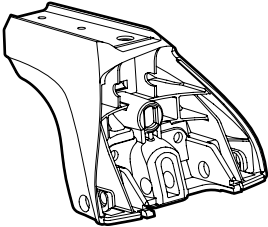

x8



x8



x8



x4



x8



x1

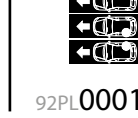

x4

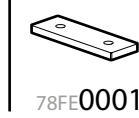

x4



x1

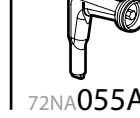

x1



x3

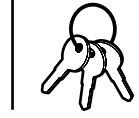

A

Imballo a parte Separate pack BARS

Contenuto • Content • Contenu • Inhalt • Contenido

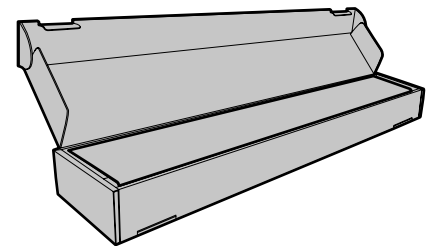

NORDRIVE **QUADRA**
Acciaio / Steel

x2

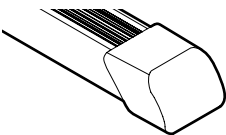

x4

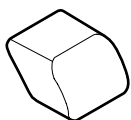

75PL097A

x1

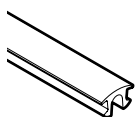

21GO164A



NORDRIVE **ALUMIA**
Alluminio / Aluminium

x2

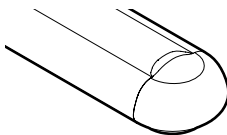

x4



75PL105A

x1

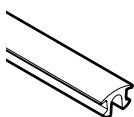

21GO164A

x2

- S** 21GO0014
- M** 21GO0001
- L** 21GO0040
- XL** 21GO0003

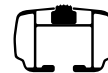

NORDRIVE **HELIO**
Alluminio / Aluminium

x2

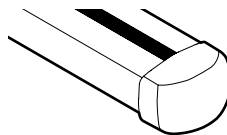

x4

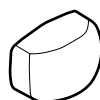

75PL0024

x2



- S** 21GO0025
- M** 21GO0026
- L** 21GO0027
- XL** 21GO0028

x2

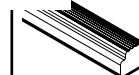

- S** 21GO0015
- M** 21GO0016
- L** 21GO0017
- XL** 21GO0018



NORDRIVE **SILENZIO**
Alluminio / Aluminium

x2

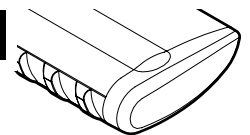

2 + 2



x1

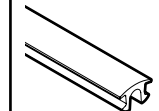

21GO164A

x4



- S** 21GO0036
- M** 21GO0037
- L** 21GO0038
- XL** 21GO0039

x2



- S** 21GO0014
- M** 21GO0001
- L** 21GO0040
- XL** 21GO0003



Attenzione • Warning • Attention • Hinweise • Advertencia

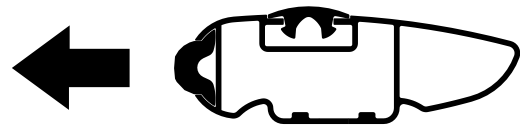
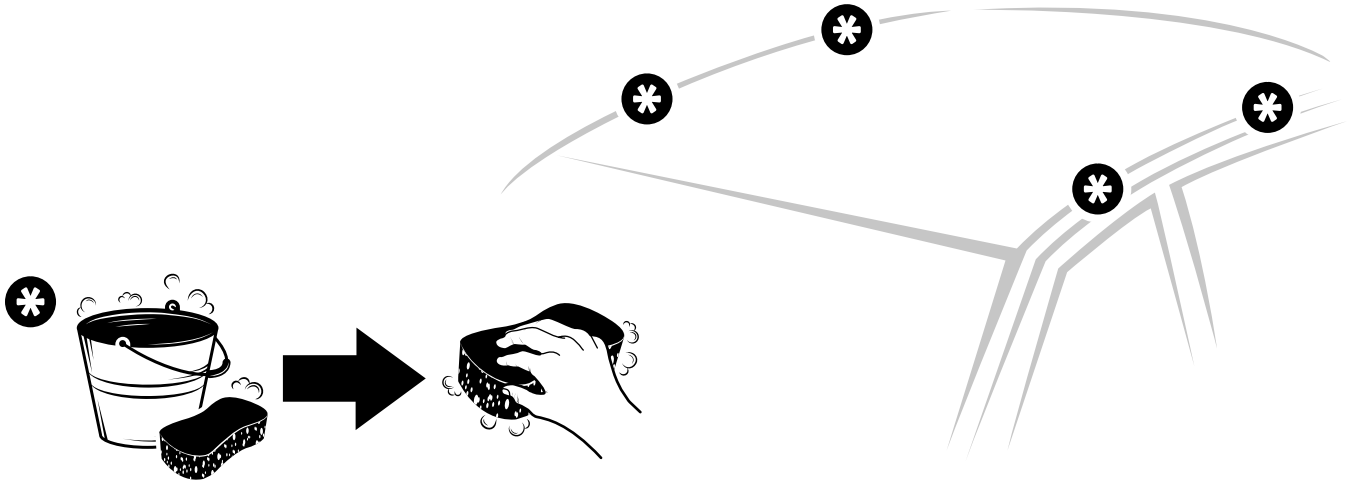

Fronte • Front • Vorderseite



Solo per barre:
Only for bars:
Nur für stangen:

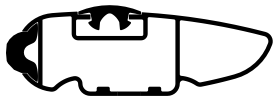
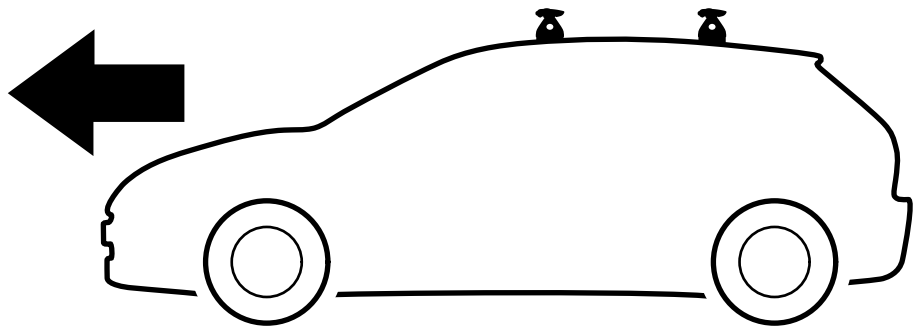

SILENZIO

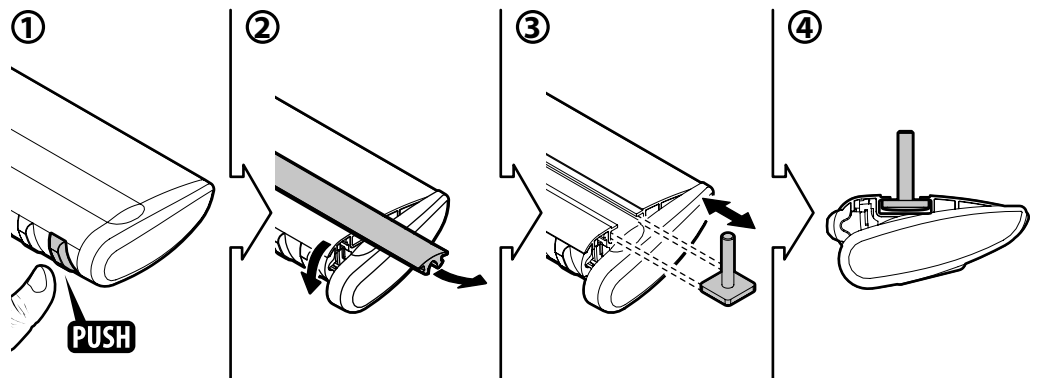



1

<p>NORDRIVE QUADRA Acciaio / Steel</p>	<p>NORDRIVE ALUMIA Alluminio / Aluminium</p>	<p>NORDRIVE HELIO Alluminio / Aluminium</p>	<p>NORDRIVE SILENZIO Alluminio / Aluminium</p>
---	---	--	---

2

① **Locked** / **Opened**

③

- M6x16 60CE6016
- ø6x11 61ED0611
- ø6x18 61FL0618

78FE0001

④

4 mm

3.0

x4

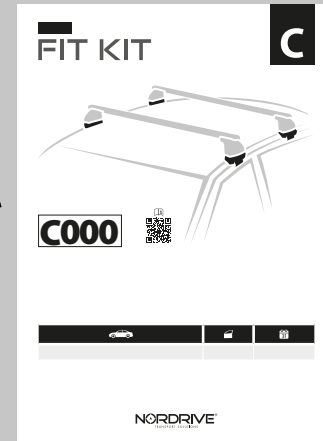
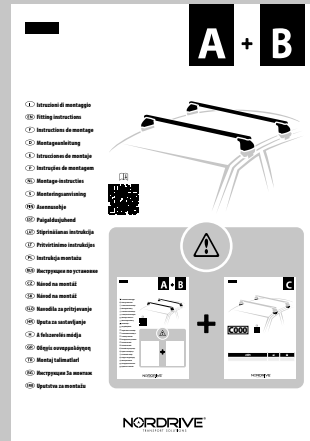

- I** Passare al manuale **C** e seguire le istruzioni come indicato ad intestazione pagina.
- EN** Switch to manual **C** and then follow the instructions as indicated above.
- F** Passez au manuel **C** et suivez les instructions comme indiqué ci-dessus.
- D** Das Handbuch **C** konsultieren und die Anleitungen wie angegeben auf Kopfzeile der Seite folgen.
- E** Vaya al manual de **C** y siga las instrucciones que se indican en el encabezado de la página.
- P** Passe para o manual **C** e siga as instruções indicadas acima.
- NL** Schakel over op manuele **C** en volg dan de instructies zoals hierboven aangegeven.
- S** Byt till manual **C** och följ där instruktionerna enligt ovan.
- FIN** Vaihda manuaaliseen **C** -sarjaan ja noudata sitten yllä olevia ohjeita.
- EST** Avage **C** juhend ja järgige ülal toodud juhiseid.
- LAT** Pārslēdzieties uz manuālo **C** un pēc tam izpildiet norādījumus, kā norādīts iepriekš.
- LT** Pereikite į vadovą **C** ir tuomet sekite instrukcijas, kaip nurodyta aukščiau.

- PL** Przełącz na ręczny **C**, a następnie postępuj zgodnie z instrukcjami, jak wskazano powyżej.
- RUS** Перейдите к руководству по **C** и следуйте инструкциям, указанным в заголовке страницы.
- CZ** Přejděte do příručky **C** a postupujte podle pokynů uvedených v záhlaví stránky.
- SK** Prejdite na návod **C** a postupujte podľa pokynov uvedených vyššie.
- SLO** Zamenjajte na navodila **C** in potem jim sledite kot je navedeno zgoraj.
- HR** Prebacite se na priručnik **C** i zatim slijedite gore navedene upute.
- H** Váltson át az **C** használati útmutatójára és kövesse a fenti utasításokat.
- GR** Μεταβείτε στο φυλλάδιο του **C** και κατόπιν ακολουθήστε τις οδηγίες που φαίνονται παραπάνω.
- TR** Manuel **C**'ye geçin ve ardından yukarıda belirtilen talimatları izleyin.
- BG** Преминете към ръководството **C** и след това следвайте инструкциите по-горе.
- SRB** Pređite na priručnik **C** a zatim sledite gore navedena uputstva.

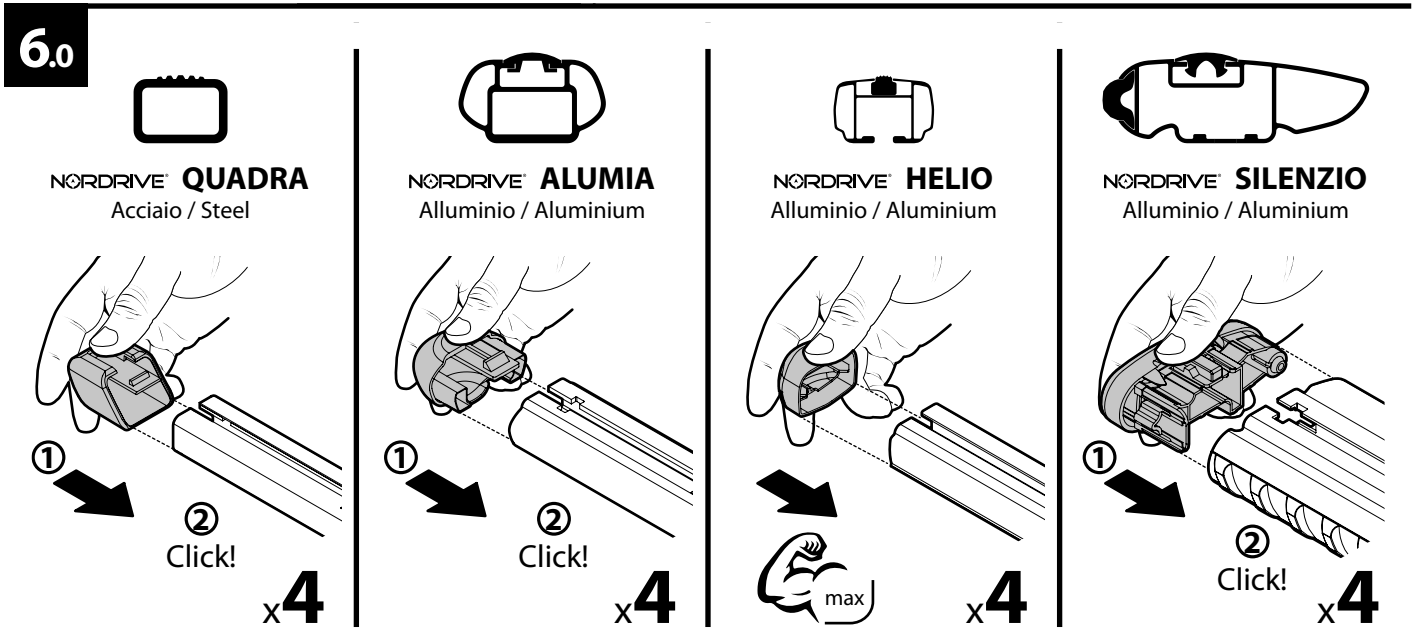
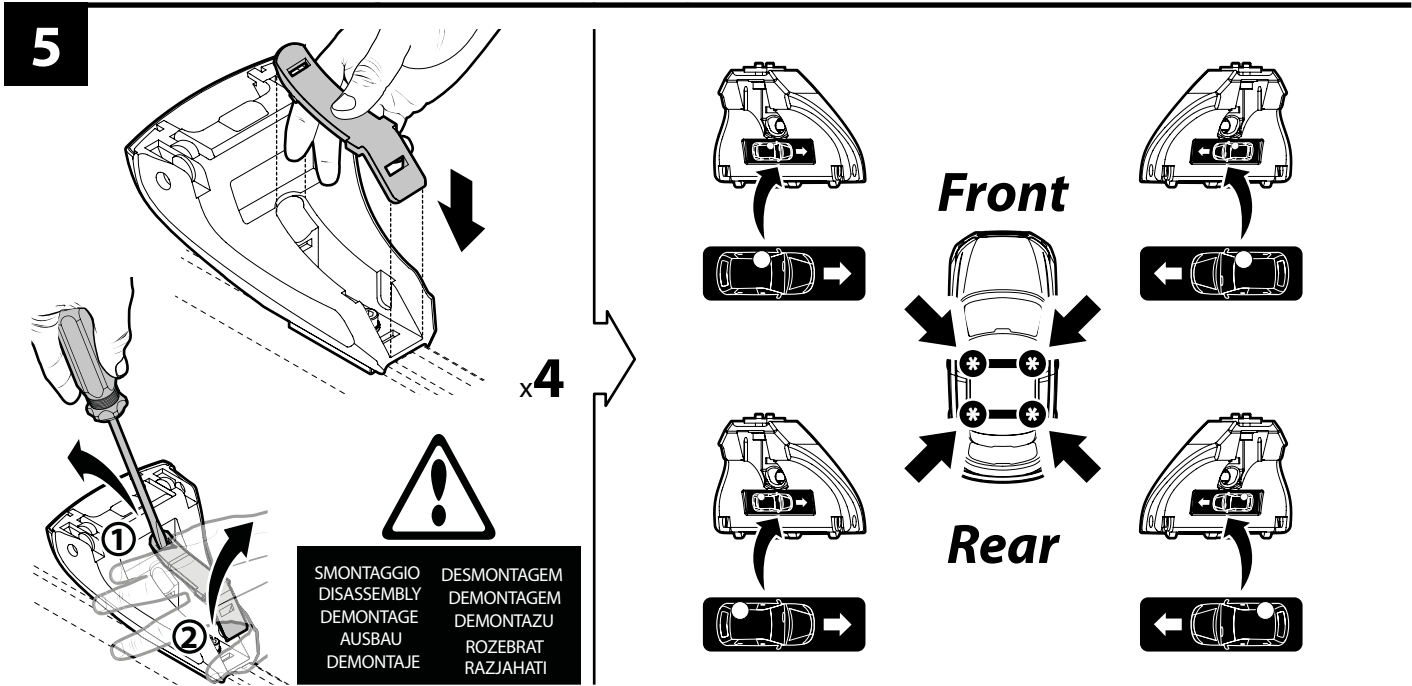
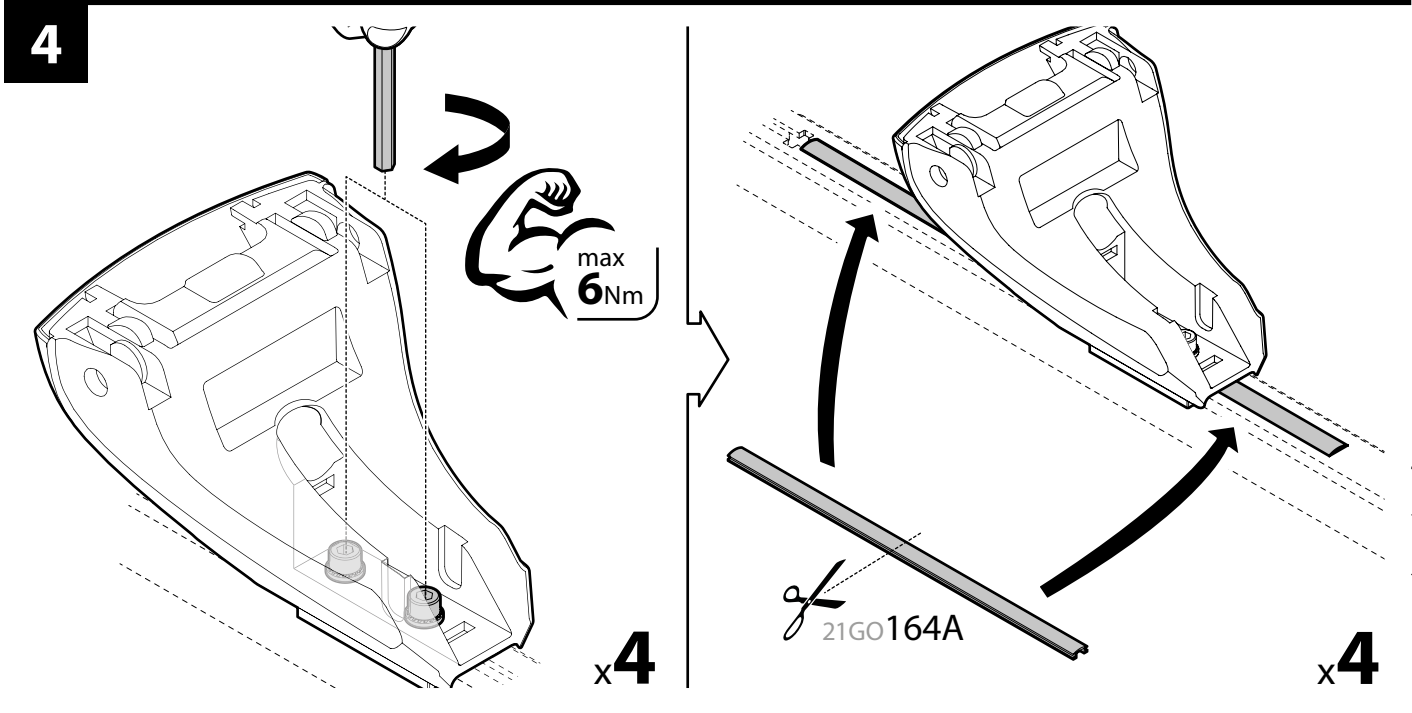

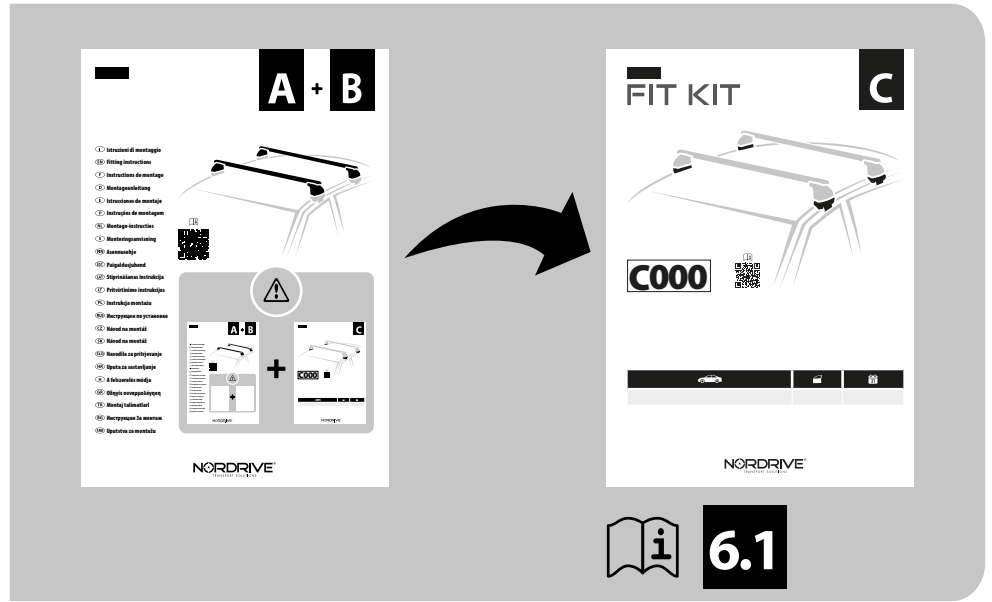

- I** Passare al manuale **C** e seguire le istruzioni come indicato ad intestazione pagina.
- EN** Switch to manual **C** and then follow the instructions as indicated above.
- F** Passez au manuel **C** et suivez les instructions comme indiqué ci-dessus.
- D** Das Handbuch **C** konsultieren und die Anleitungen wie angegeben auf Kopfzeile der Seite folgen.
- E** Vaya al manual de **C** y siga las instrucciones que se indican en el encabezado de la página.
- P** Passe para o manual **C** e siga as instruções indicadas acima.
- NL** Schakel over op manuele **C** en volg dan de instructies zoals hierboven aangegeven.
- S** Byt till manual **C** och följ där instruktionerna enligt ovan.
- FIN** Vaihda manuaaliseen **C** -sarjaan ja noudata sitten yllä olevia ohjeita.
- EST** Avage **C** juhend ja järgige ülal toodud juhiseid.
- LAT** Pārslēdzieties uz manuālo **C** un pēc tam izpildiet norādījumus, kā norādīts iepriekš.
- LT** Pereikite į vadovą **C** ir tuomet sekite instrukcijas, kaip nurodyta aukščiau.

- PL** Przełącz na ręczny **C**, a następnie postępuj zgodnie z instrukcjami, jak wskazano powyżej.
- RUS** Перейдите к руководству по **C** и следуйте инструкциям, указанным в заголовке страницы.
- CZ** Přejděte do příručky **C** a postupujte podle pokynů uvedených v záhlaví stránky.
- SK** Prejdite na návod **C** a postupujte podľa pokynov uvedených vyššie.
- SLO** Zamenjajte na navodila **C** in potem jim sledite kot je navedeno zgoraj.
- HR** Prebacite se na priručnik **C** i zatim slijedite gore navedene upute.
- H** Váltson át az **C** használati útmutatójára és kövesse a fenti utasításokat.
- GR** Μεταβείτε στο φυλλάδιο του **C** και κατόπιν ακολουθήστε τις οδηγίες που φαίνονται παραπάνω.
- TR** Manuel **C**'ye geçin ve ardından yukarıda belirtilen talimatları izleyin.
- BG** Преминете към ръководството **C** и след това следвайте инструкциите по-горе.
- SRB** Pređite na priručnik **C** a zatim sledite gore navedena uputstva.



Attenzione • Warning • Attention • Hinweise • Advertencia

7

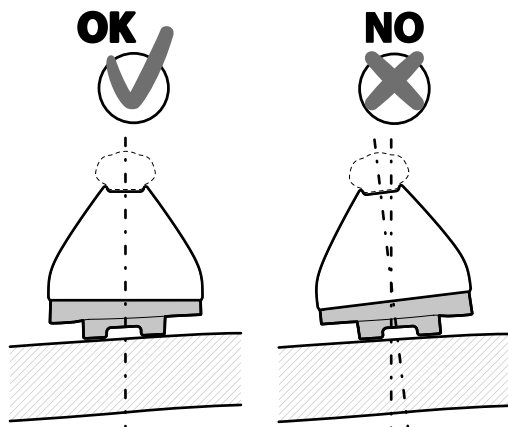
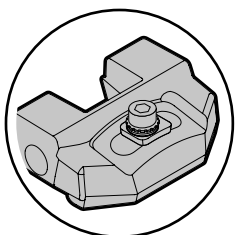
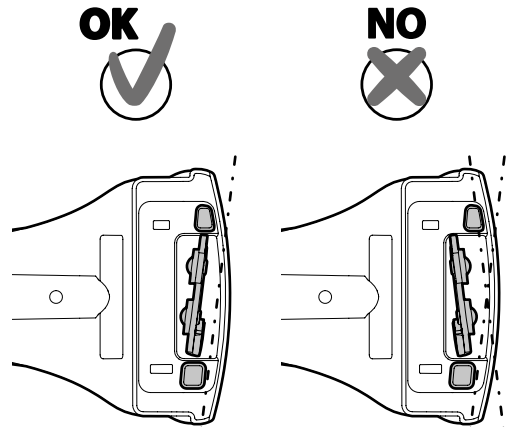
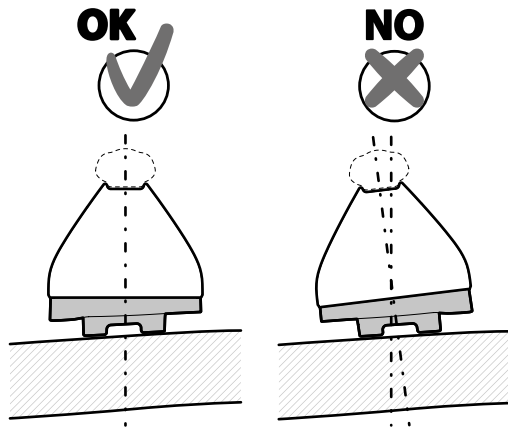
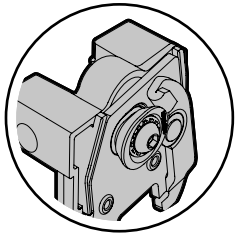
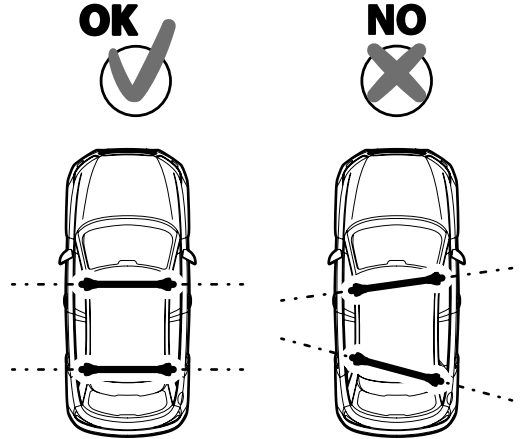
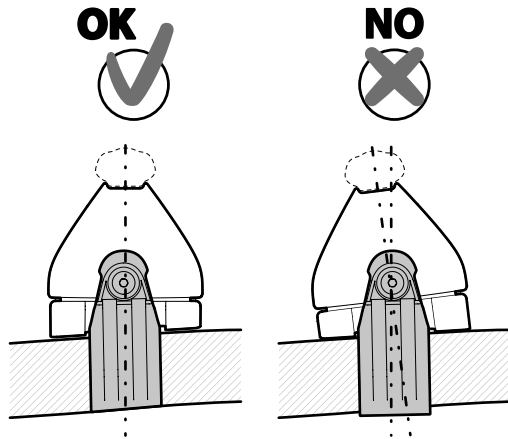
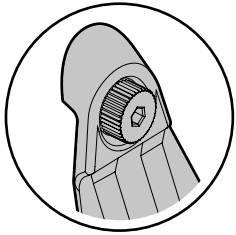

8

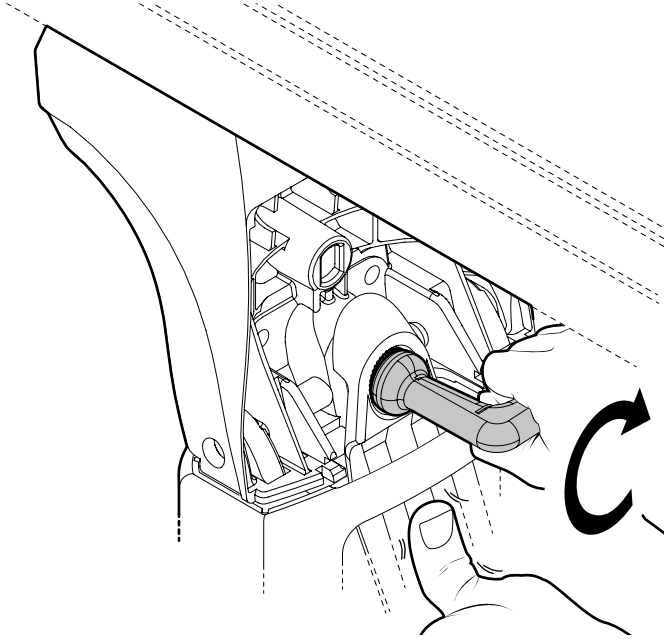
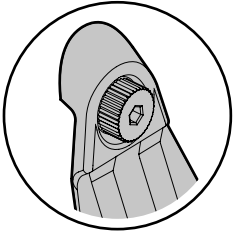

x4

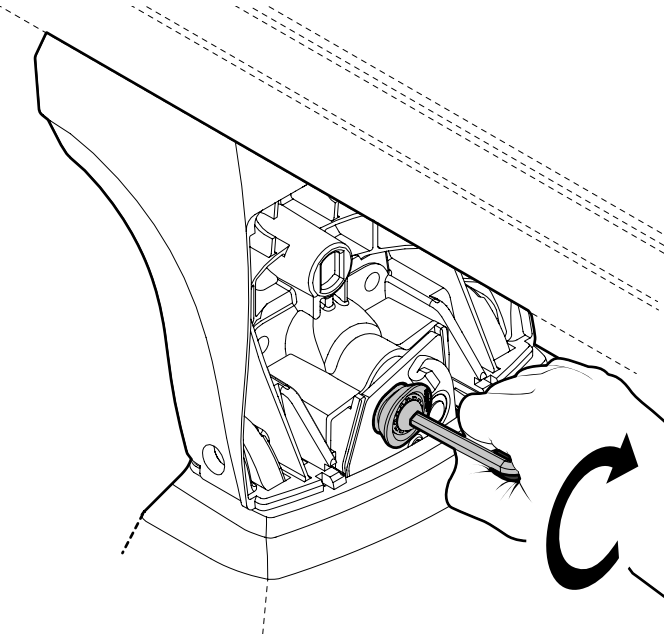
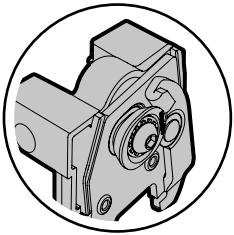

x4

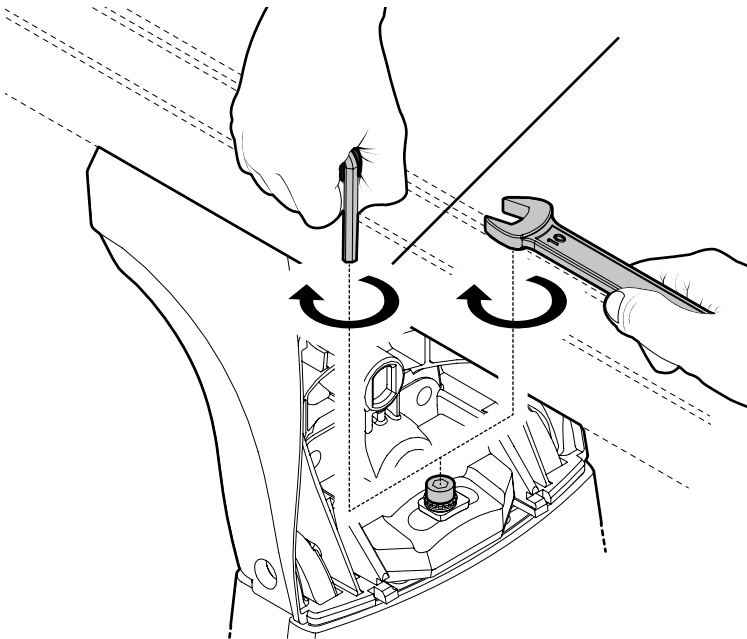
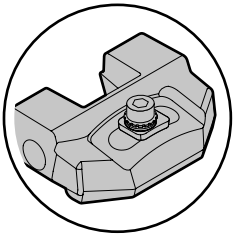

x4

9

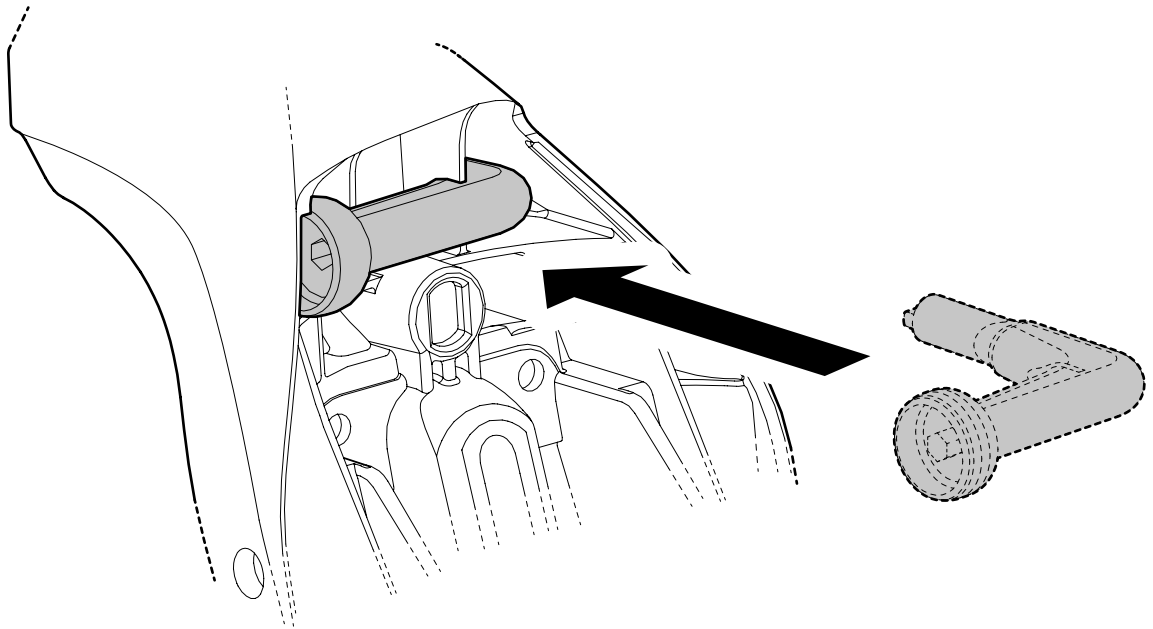

10

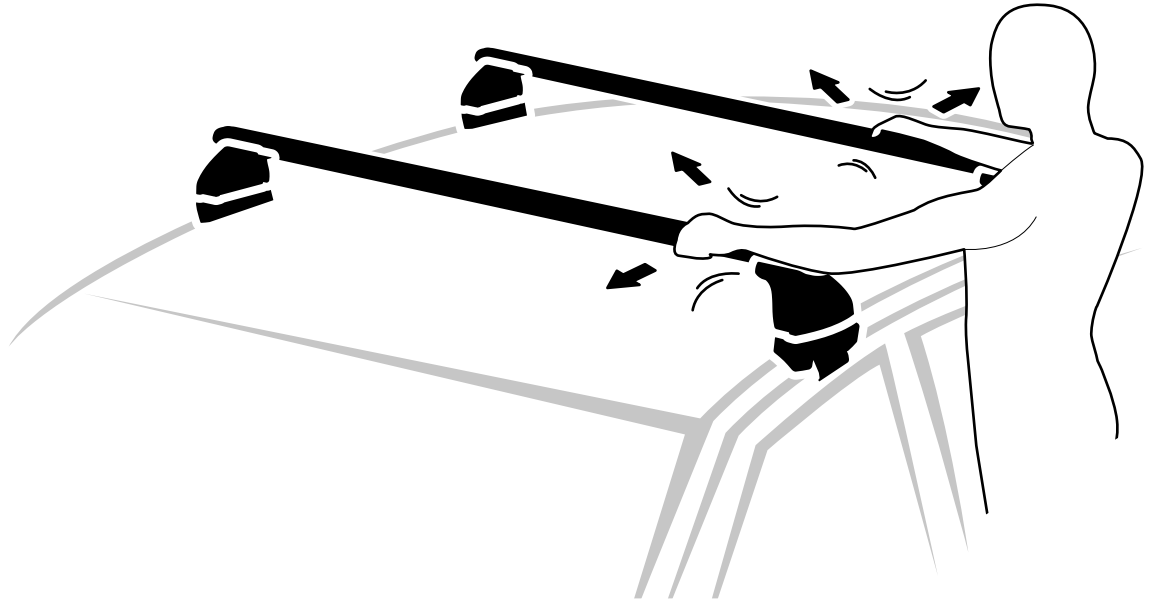

11

Front

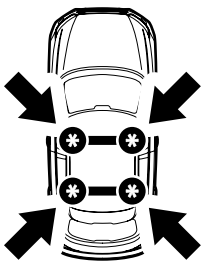

Rear

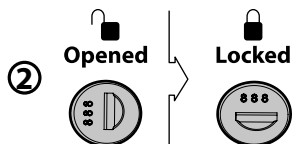
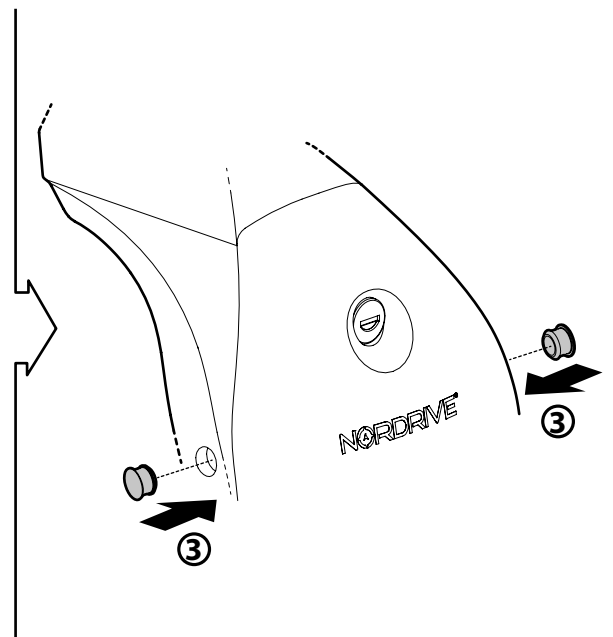
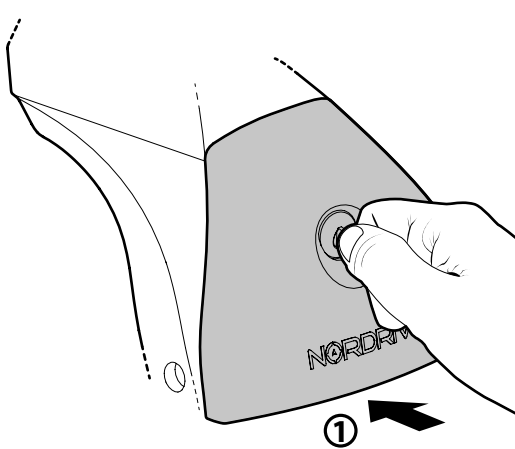



Attenzione • Warning • Attention • Hinweise • Advertencia

0100 Km

Pit-stop / Check!

0250 Km

Pit-stop / Check!

0500 Km

Pit-stop / Check!

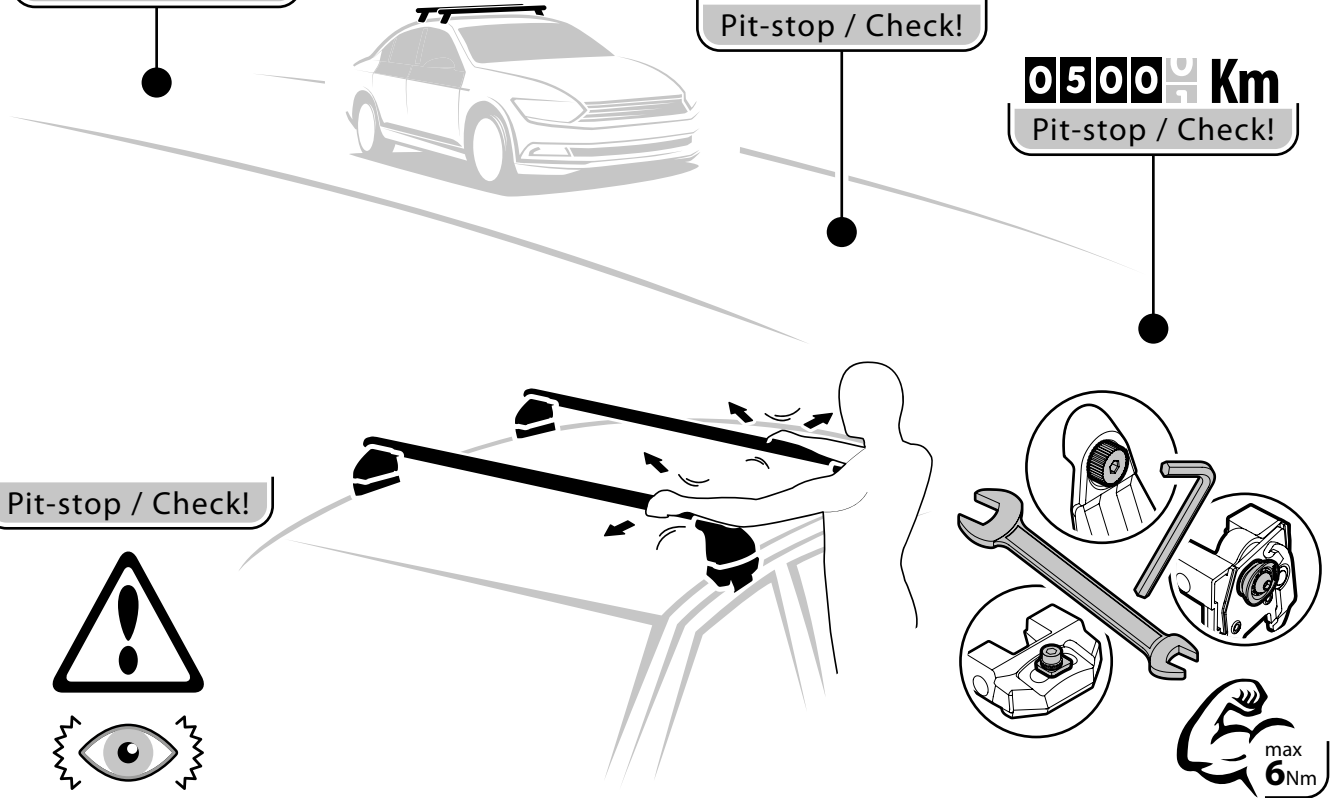

Pit-stop / Check!



1 x Year

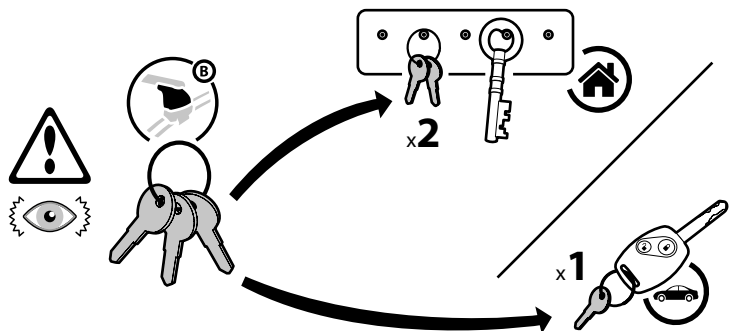
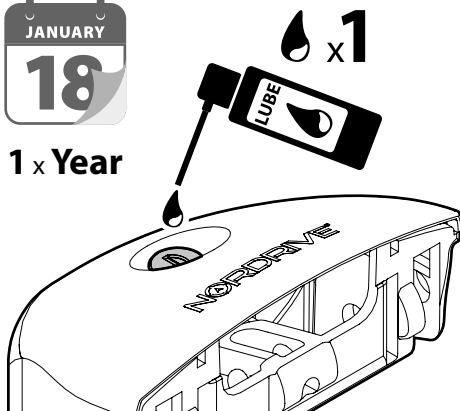

- ① Lotto di produzione da comunicare per eventuali ricambi
- Ⓒ Production lot number to be communicated for any spare parts
- Ⓕ Lot de production à communiquer pour toute pièce de rechange
- Ⓓ Produktionscharge für eventuelle Ersatzteile
- Ⓔ Lote de producción a comunicar por cualquier repuesto

Lot.

NORDRIVE®
TRANSPORT SOLUTIONS

**NORDRIVE® is a registered trademark of
LAMPA S.p.A.**

Via G. Rossa 53/55, 46019 Viadana (MN) ITALY

Tel. +39 0375 820700

UNI EN ISO 9001:2015 Certified Company

www.nordrive.it www.lampa.it

91CA0236 r08