









VOLKSWAGEN ID.3 2020

MOC SKT 0443

MOC SRR0AL0006 cm 110

MOC SRR0AC0010 cm 110

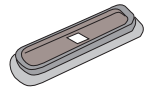

1 - L1240/4 ant. dx 	1 - L1169/25 post.sx 	8 - RCVM6X9Q 
1 - L1240/3 ant. sx 	4 - L1204/4 	4 - RC20200026 
1 - L1169/15 post. dx 	4 - L1058/8 	1 - RCBR5 

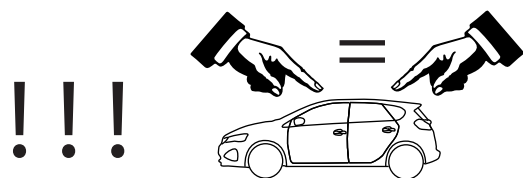
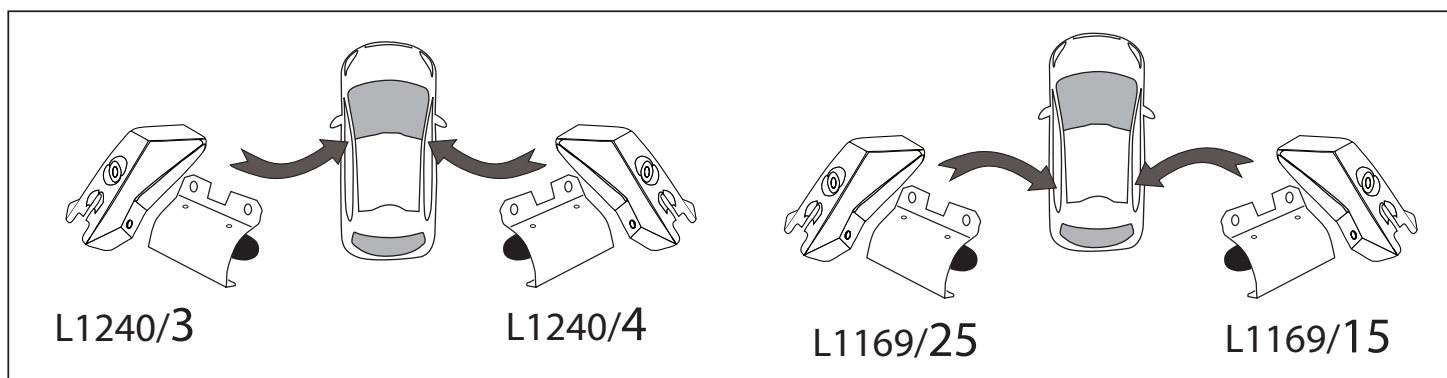
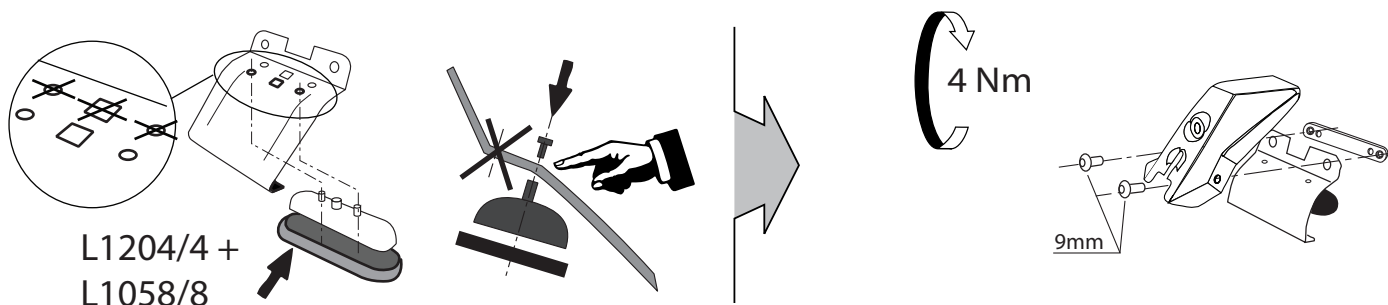

MOC SRR0AC0010 cm 110
MOC SRR0AL0006 cm 110

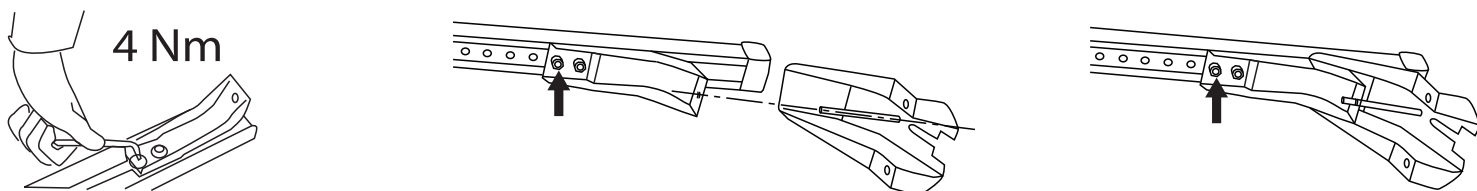
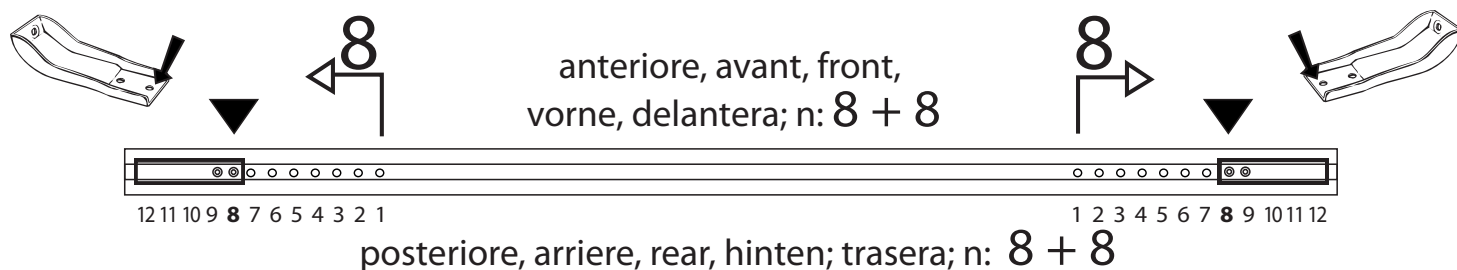

MOCSKT 0433

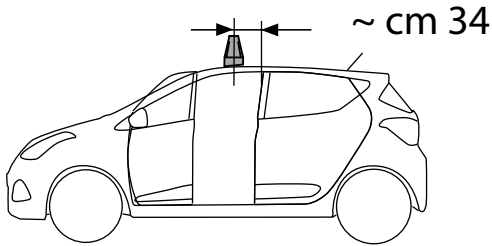
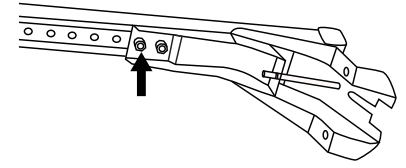
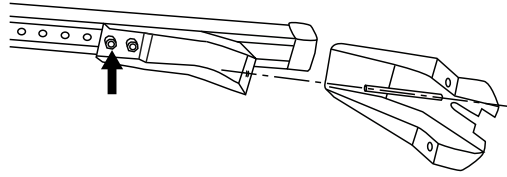
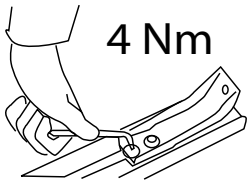

L1240/4 +
L1204/4

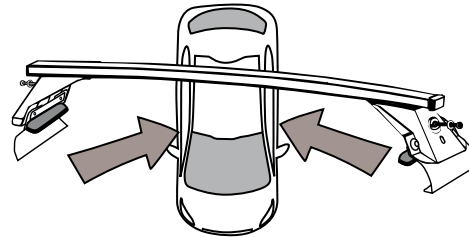

L1240/3 +
L1204/4

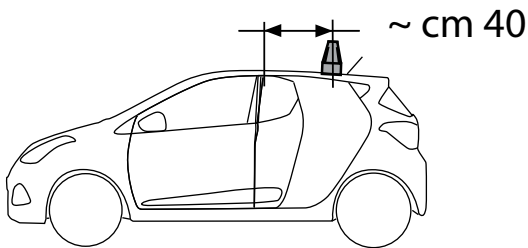

L1169/15 +
L1204/4

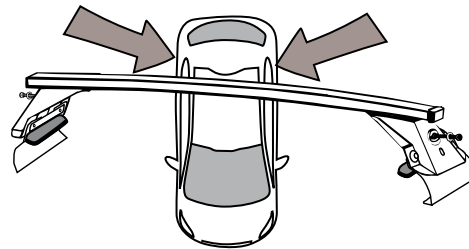

L1169/25 +
L1204/4

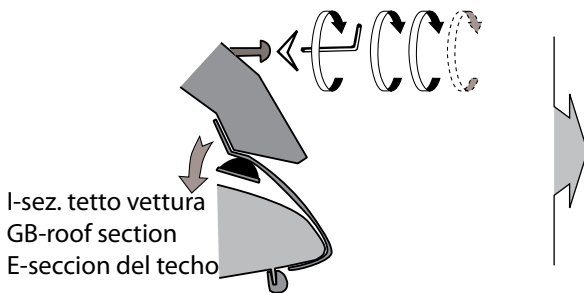

I-sez. tetto vettura
GB-roof section
E-seccion del techo

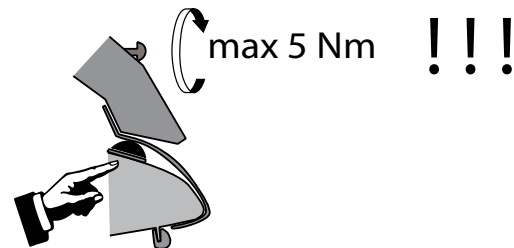

I - Per stringere, usare la chiave come indicato nel disegno. (Non si assumono responsabilità per danni causati dall'impiego di chiavi diverse da quella in dotazione al prodotto).
F - Pour serrer, utiliser la clé comme indiqué ci dessous.

GB - To tighten please use the wrench as per the drawing.
D - Zum Anziehen benutzen Sie bitte den Inbusschlüssel, nur wie auf dem Bild dargestellt.
E - Para el correcto ajuste, utilizar la llave fija tal y como se indica en la imagen

