

FIAT Nuova 500 model 2020
 FIAT Nuova 500 Cabrio model 2020

Patent pending
MOCSKT 0442

MOCSRR0AC0010 cm 110
MOCSRR0AL0006 cm 110



	1 - L1328/3 1 - L1328/4			1 - L1169/38 1 - L1169/48	
2 - L1058/7		2 - RCVM6X16TSQ		2 - RC20200026	
2 - L1058/8		2 - RCRD8Q		1 - RCBR5	
2 - L1204/4		8 - RCVM6X9Q		1 - RCBR4	

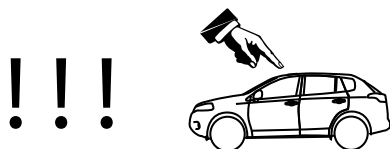
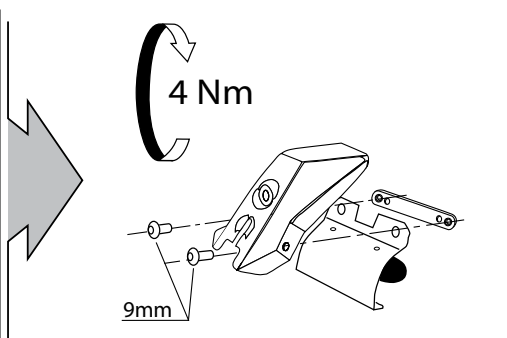
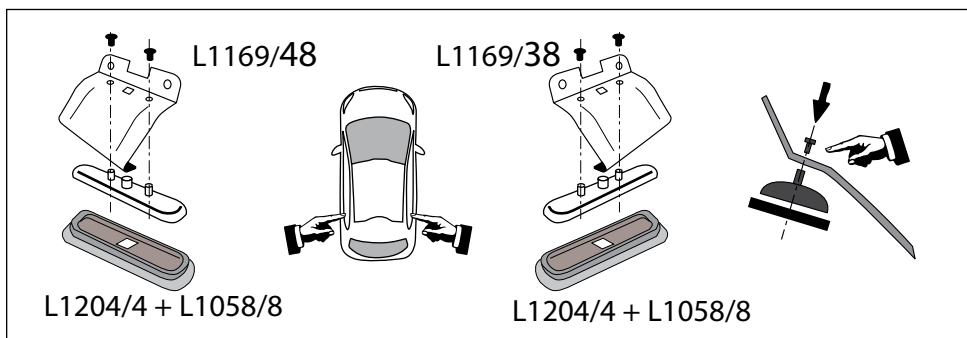
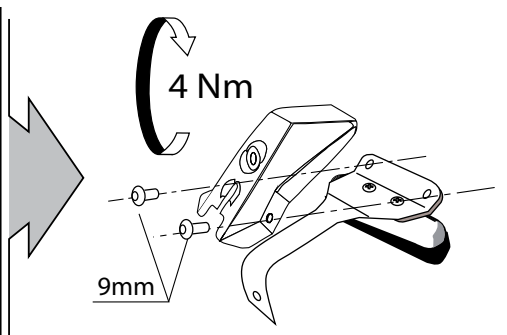
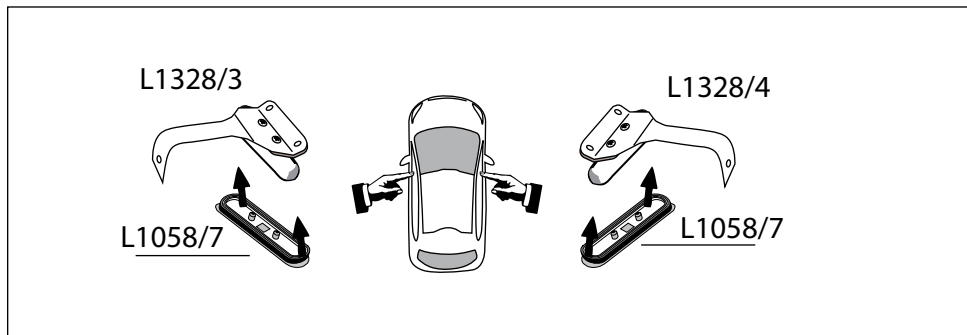

MOCSRR0AC0010 cm 110
MOCSRR0AL0006 cm 110

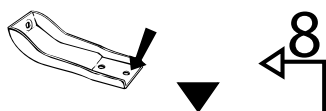

anteriore, avant, front,
 vorne, delantera

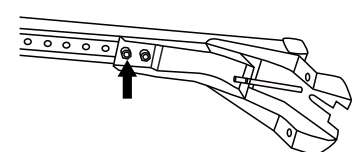
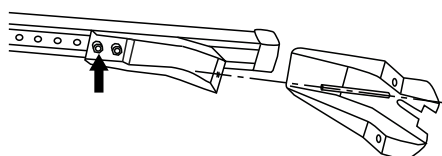
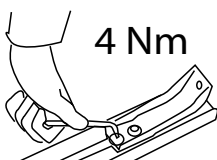
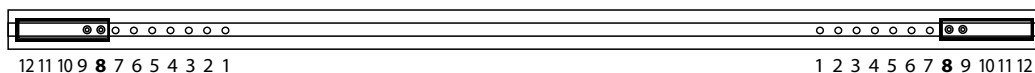
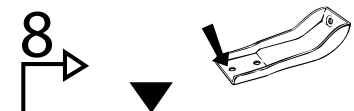

!!!



MOCSRR0AC0010 cm 110
MOCSRR0AL0006 cm 110

MOCSKT 0442

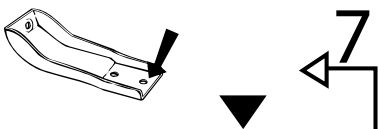

posteriore, arriere, rear,
hinten; trasera

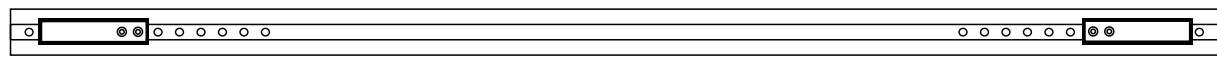
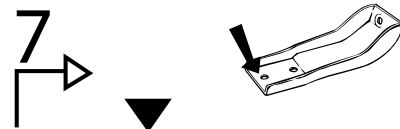

12 11 10 9 8 7 6 5 4 3 2 1

1 2 3 4 5 6 7 8 9 10 11 12

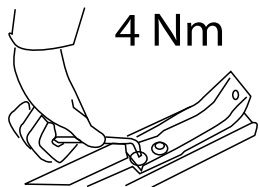

4 Nm

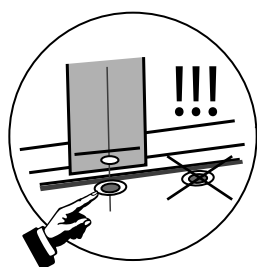
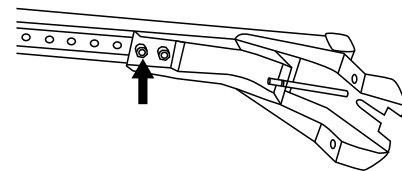
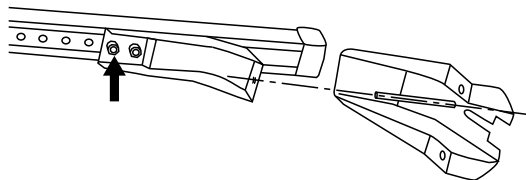

L1328/3 cm 72 L1169/38
L1328/4 L1169/48

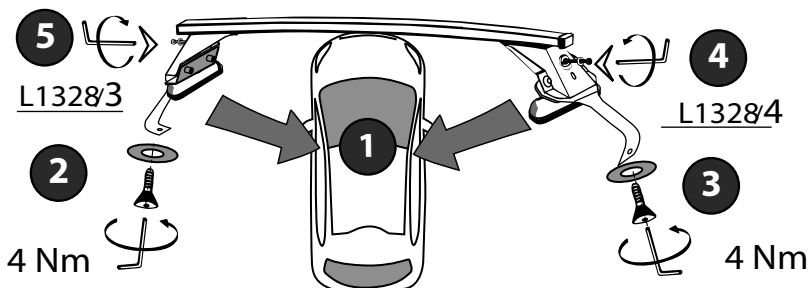
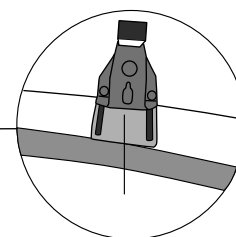
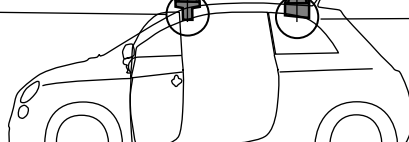

L1328/3

L1328/4

4 Nm

4 Nm

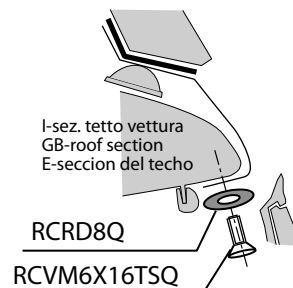

I-sez. tetto vettura
GB-roof section
E-seccion del techo

RCRD8Q

RCVM6X16TSQ

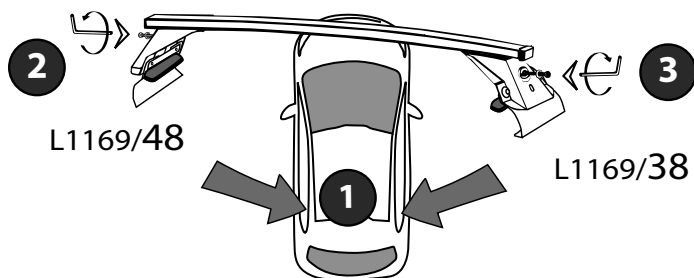

L1169/48

L1169/38

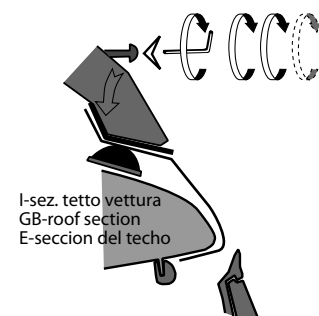

I-sez. tetto vettura
GB-roof section
E-seccion del techo

I - Per stringere, usare la chiave come indicato nel disegno. (Non si assumono responsabilità per danni causati dall'impiego di chiavi diverse da quella in dotazione al prodotto).
F - Pour serrer, utiliser la clé comme indique ci dessus.

GB - To tighten please use the wrench as per the drawing.
D - Zum Anziehen benutzen Sie bitte den Inbusschlüssel, nur wie auf dem Bild dargestellt.
E - Para el correcto ajuste, utilizar la llave fija tal y como se indica en la imagen

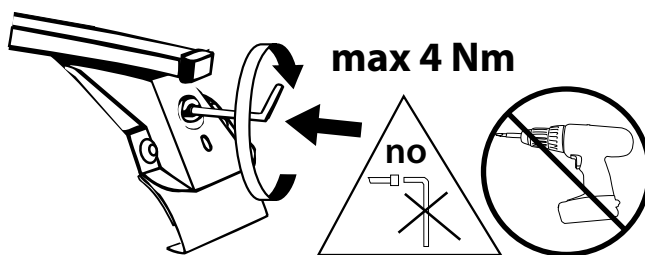

max 4 Nm

no

MODULA
case system

email: modulacs@modulacs.com
web site: www.modulacs.com

Modula s.r.l.
Loc. Penisola, 20/A
61026 Piandimeleto (PU) ITALY
phone +39 0722/700070
fax +39 0722/720017

08-03-2021