

## MOCSRR0AC0010 cm 110 MOCSRR0AL0006 cm 110

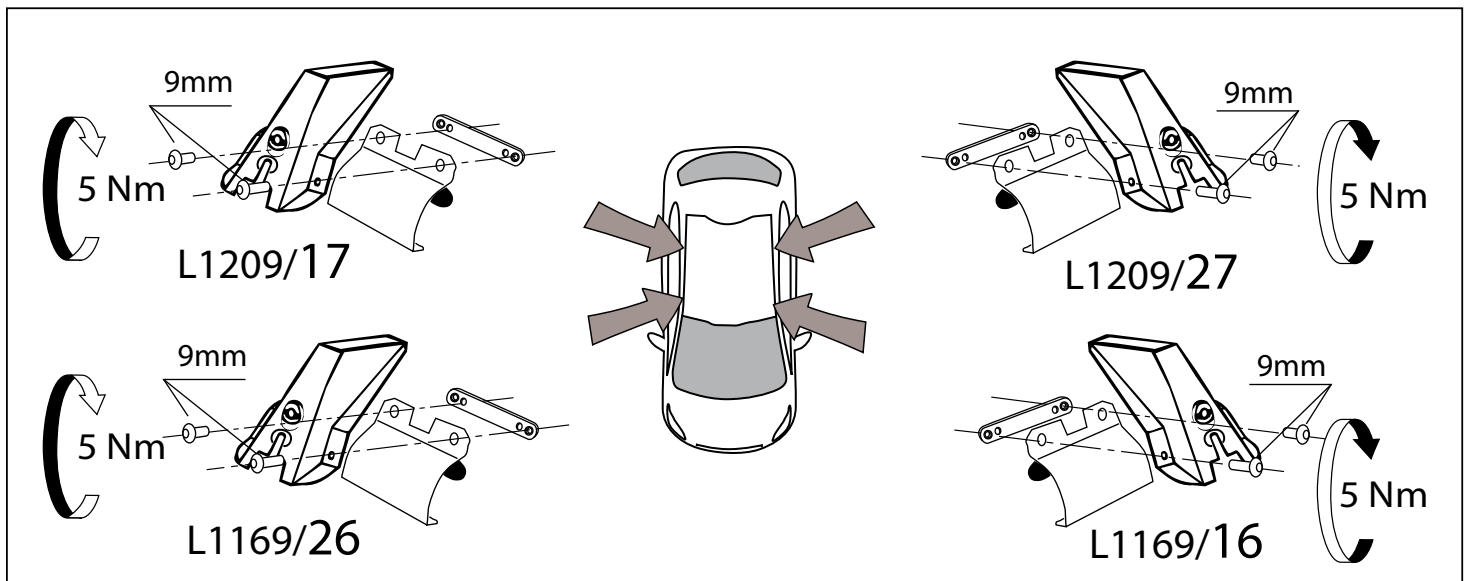

1 - L1169/16 ant. sx		1 - L1209/17 post. dx		8 - RCVM6X9Q	
1 - L1169/26 ant. dx		1 - L1209/27 post. sx		4 - RC20200026	
2 - L1204/4		2 - L1061/4		1 - RCBR5	
2 - L1058/8		2 - L1058/7			

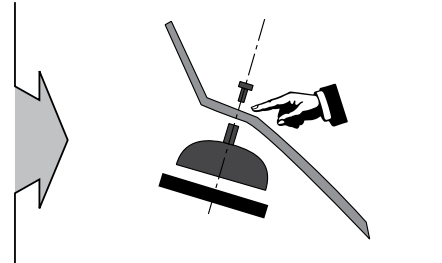
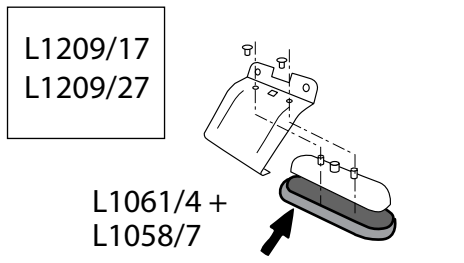
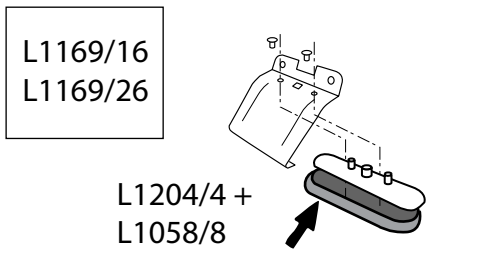

### MOCSRR0AC010 cm 110 MOCSRR0AL006 cm 110

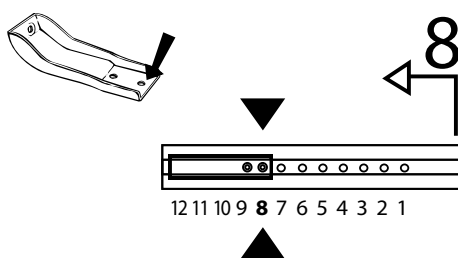

anteriore, avant, front,  
vorne, delantera

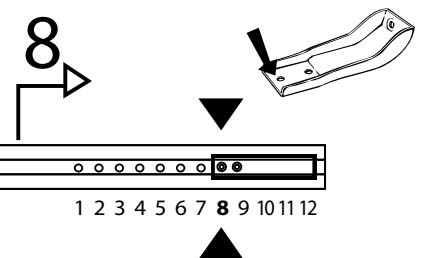

posteriore, arriere,  
rear, hinten, trasera

# MOCSKT 0426

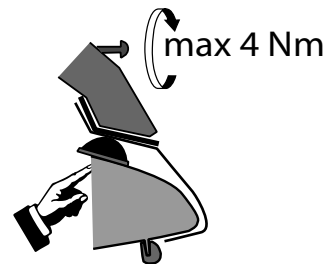
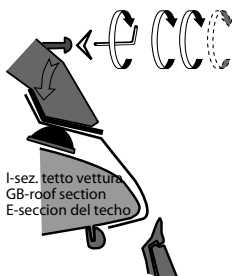
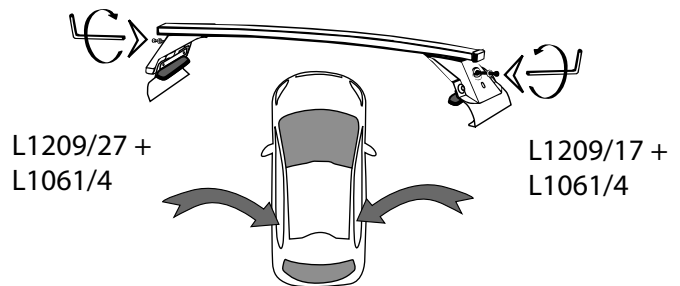
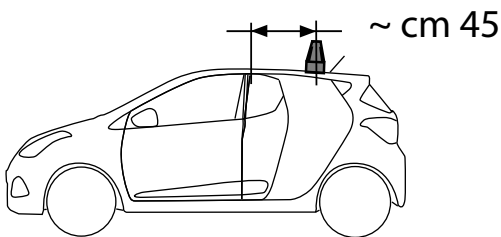
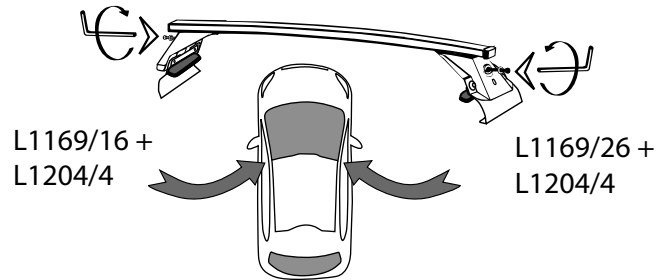
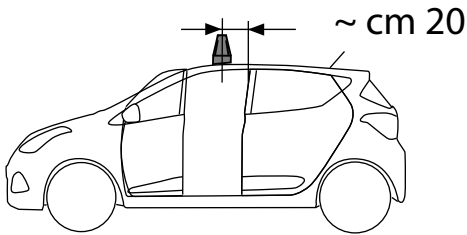
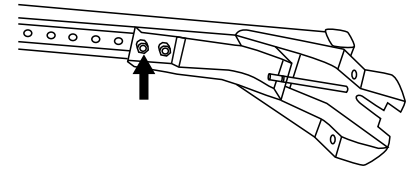
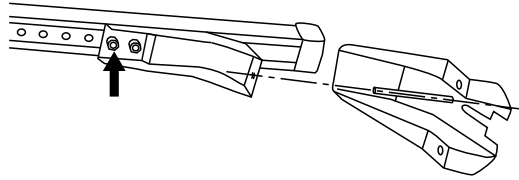
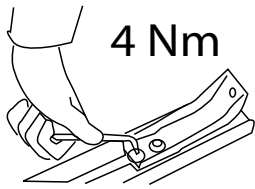

I - Per stringere, usare la chiave come indicato nel disegno. (Non si assumono responsabilità per danni causati dall'impiego di chiavi diverse da quella in dotazione al prodotto).  
F - Pour serrer, utiliser la clé comme indique ci dessous.

GB - To tighten please use the wrench as per the drawing.  
D - Zum Anziehen benutzen Sie bitte den Inbusschlüssel, nur wie auf dem Bild dargestellt.  
E - Para el correcto ajuste, utilizar la llave fija tal y como se indica en la imagen

