





BMW X 4 2018 no rails

MOCSKT 0406

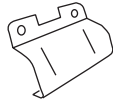
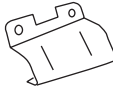
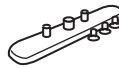
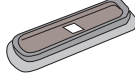
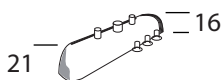

MOCSRROAC0011 cm 124

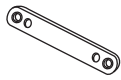
MOCSRROAL0007 cm 124

<p>2 - L1045/35 ant. sx post. dx</p>  <p>2 - L1045/45 ant. dx post. sx</p> 	<p>2 - L1204/4</p>  <p>2 - L1058/8</p>  <p>2 - L1315/6</p>  <p>2 - L1058/7</p> 	<p>8 - RCVM6X9Q</p>  <p>4 - RC20200026</p>  <p>1 - RCBR5</p> 
---	---	--

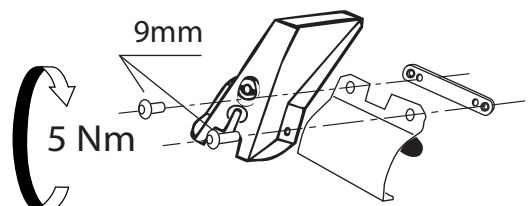
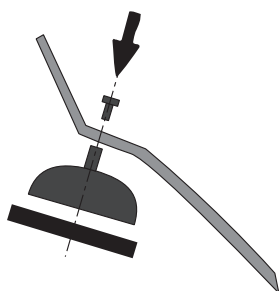
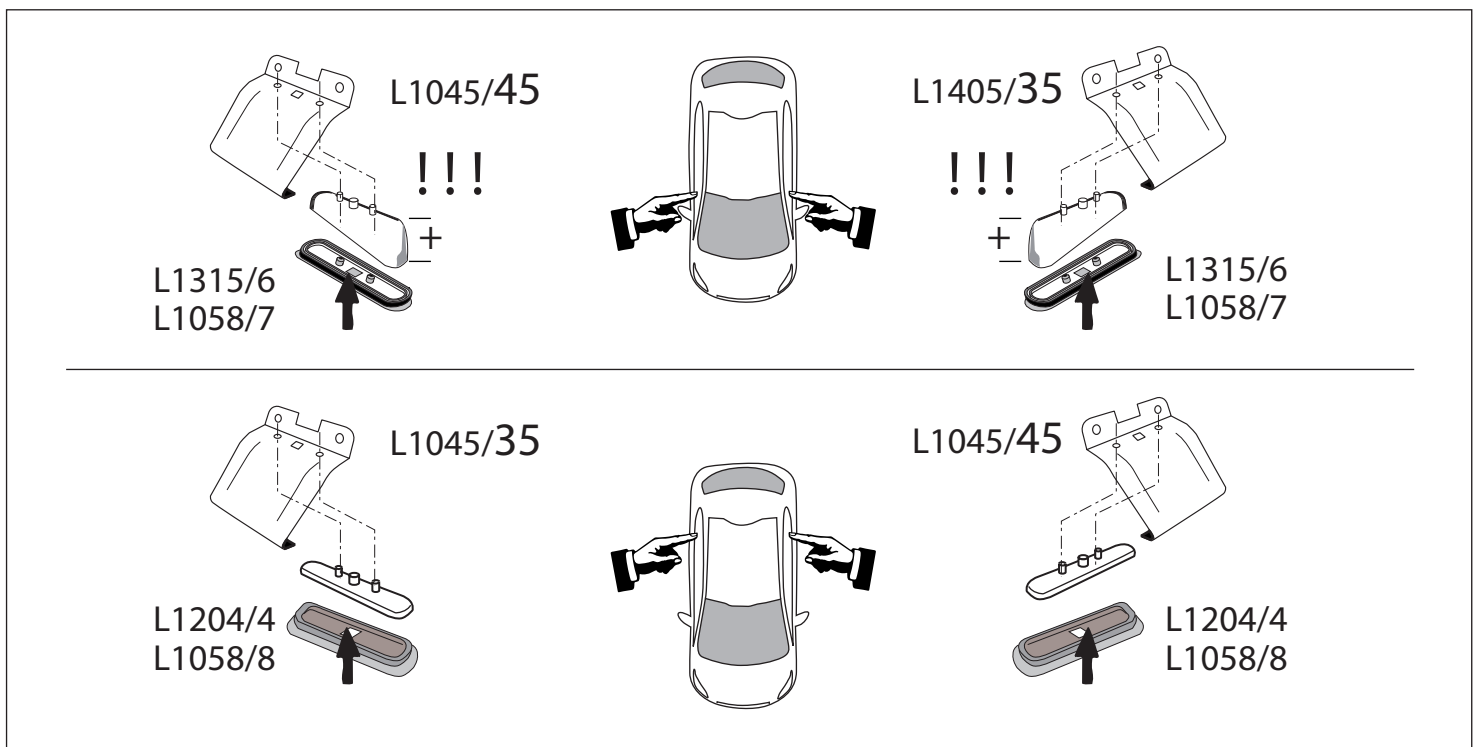

MOCSKT 0406



MOCSRR0AC0011 cm 124
MOCSRR0AL0007 cm 124

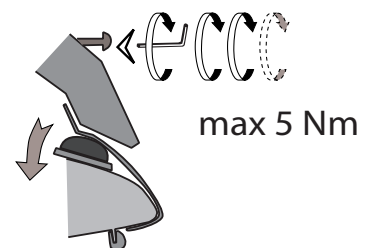
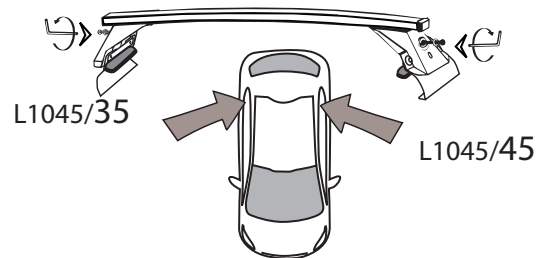
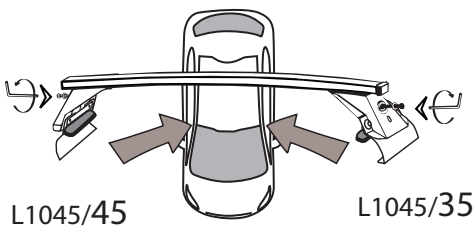
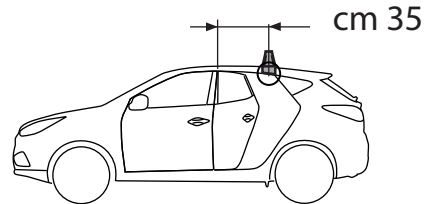
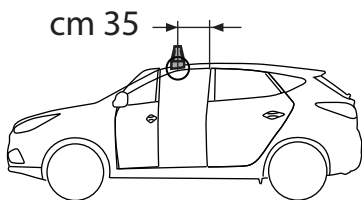
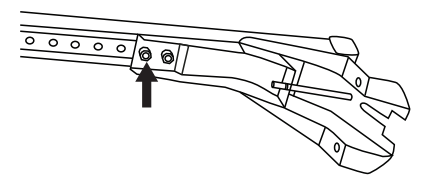
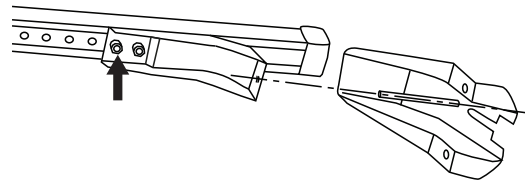
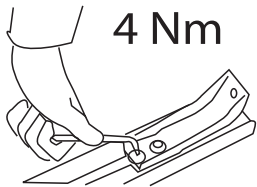
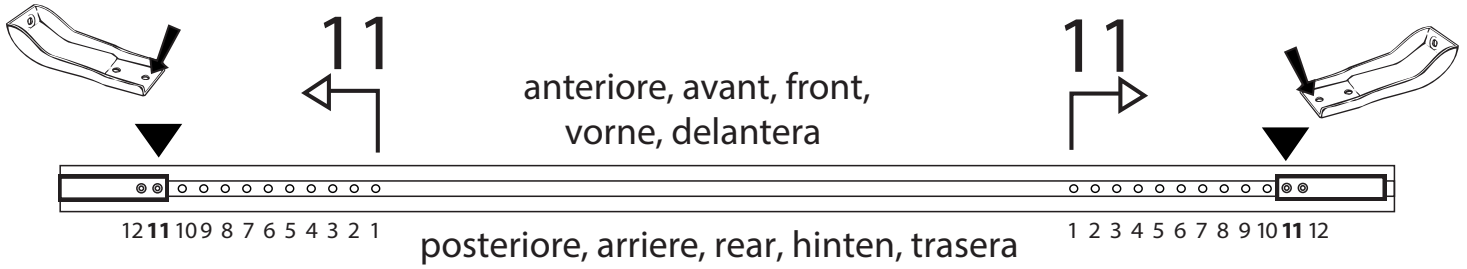

I - Per stringere, usare la chiave come indicato nel disegno. (Non si assumono responsabilità per danni causati dall'impiego di chiavi diverse da quella in dotazione al prodotto).
 F - Pour serrer, utiliser la clé comme indique ci dessous.

GB - To tighten please use the wrench as per the drawing.
 D - Zum Anziehen benutzen Sie bitte den Inbusschlüssel, nur wie auf dem Bild dargestellt.
 E - Para el correcto ajuste, utilizar la llave fija tal y como se indica en la imagen

