

# Jaguar F-Pace no rails model 2015

# MOCSKT 0393

**MOCSRR0AC0011 cm 124**

**MOCSRR0AL0007 cm 124**



4 - L1110/4		2 - L1061/4 2 - L1058/7 +		2 - L1204/4 2 - L1058/8 -		4 - RC20200026 8 - RCVM6X9Q 1 - RCBR5	
-------------	--	---------------------------------	--	---------------------------------	--	---	--

!!! 2 - L1061/4  
2 - L1058/7

L1110/4

4 Nm  
9mm

!!! 2 - L1204/4  
2 - L1058/8

L1110/4

4 Nm  
9mm

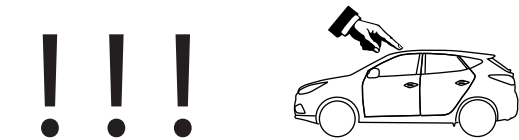

**MOCSRR0AC0011 cm 124**

**MOCSRR0AL0007 cm 124**

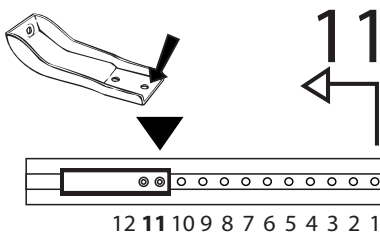

anteriore, avant, front,  
vorne, delantera

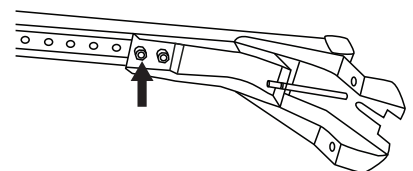
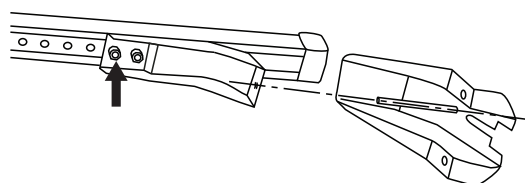
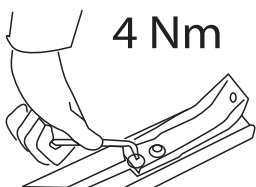
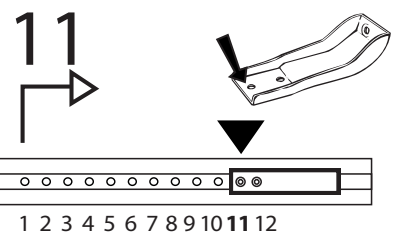

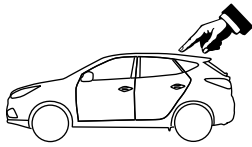

**MOCSRR0AC0011 cm 124**  
**MOCSRR0AL0007 cm 124**

**MOCSKT 0393**

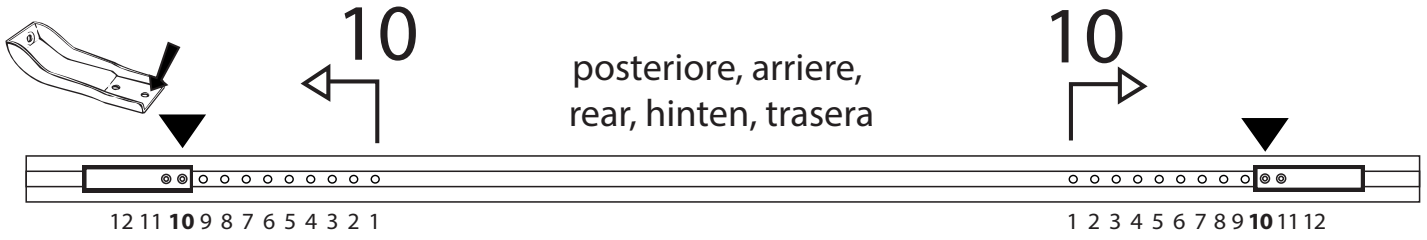

posteriore, arriere,  
rear, hinten, trasera

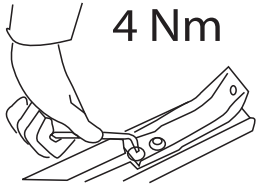

4 Nm

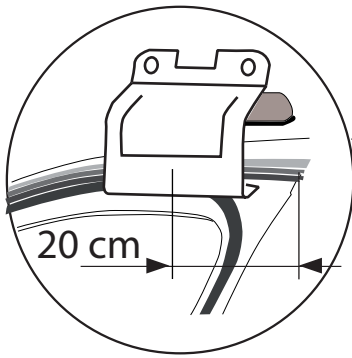
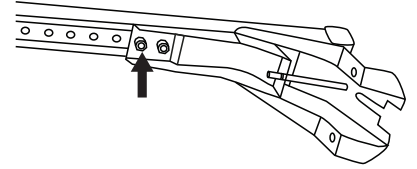
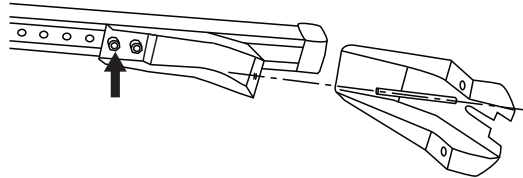

20 cm

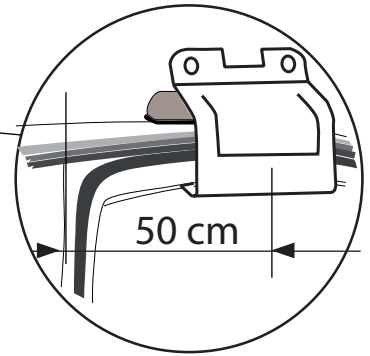
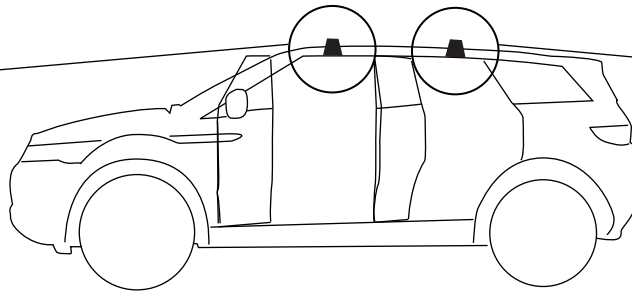

50 cm

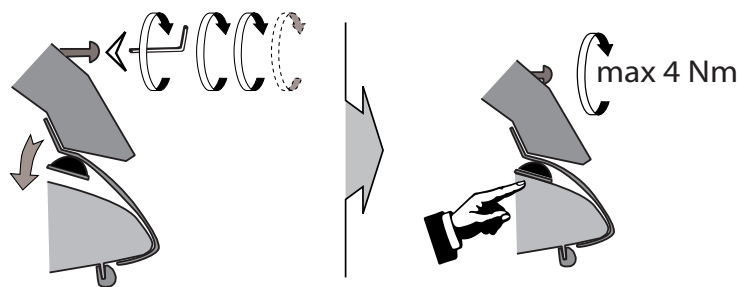

max 4 Nm

I - Per stringere, usare la chiave come indicato nel disegno. (Non si assumono responsabilità per danni causati dall'impiego di chiavi diverse da quella in dotazione al prodotto).  
 F - Pour serrer, utiliser la clé comme indique ci dessous.

GB - To tighten please use the wrench as per the drawing.  
 D - Zum Anziehen benutzen Sie bitte den Inbusschlüssel, nur wie auf dem Bild dargestellt.  
 E - Para el correcto ajuste, utilizar la llave fija tal y como se indica en la imagen

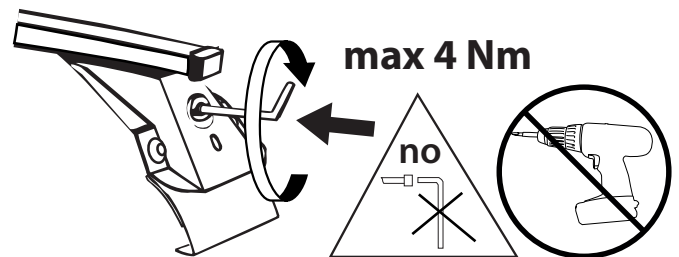

max 4 Nm

no