









FORD Fiesta 3 porte/doors model 2017

**MOCSKT 0365**

**MOCSRROAC0010 cm 110**

**MOCSRROAL0006 cm 110**

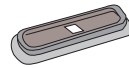
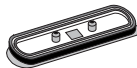
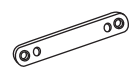

|  |  |   |   |
|--|--|---|---|
| 1 - L1484/1<br>ant. sx<br><br>1 - L1484/2<br>ant. dx<br><br>2 - L1315/6<br> | 1 - L1342/3<br>post. dx<br><br>1 - L1342/4<br>post. sx<br><br>2 - L1204/4<br> | 2 - L1058/8<br><br>2 - L1058/7<br><br>4 - RC20200026<br> | 8 - RCVM6X9Q<br><br>1 - RCBR5<br> |
|--|--|---|---|

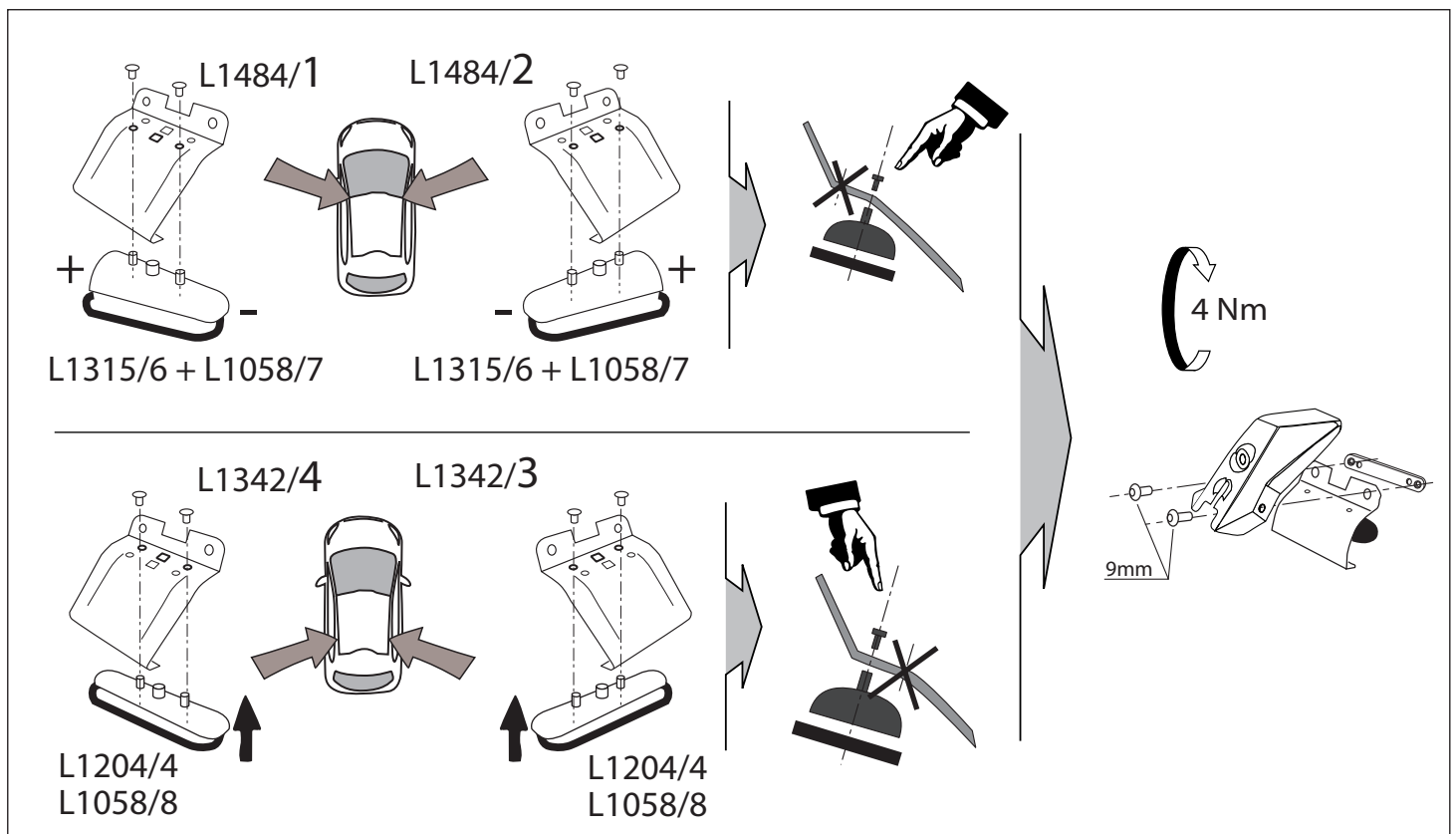

**MOCSRROAC0010 cm 110**  
**MOCSRROAL0006 cm 110**

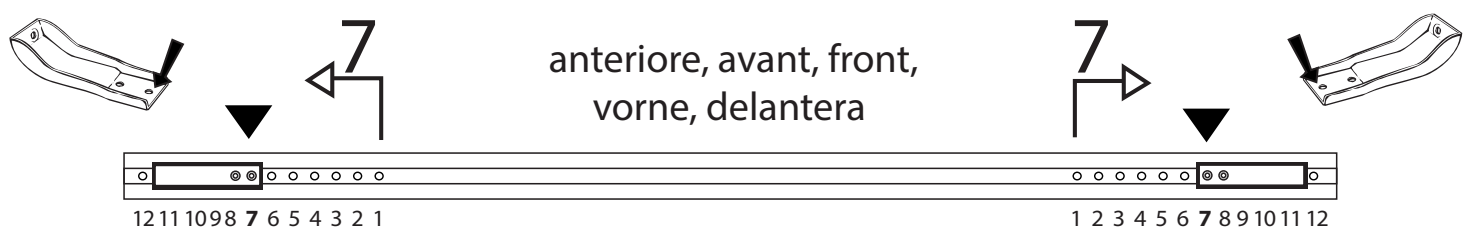

# MOCSKT 0365

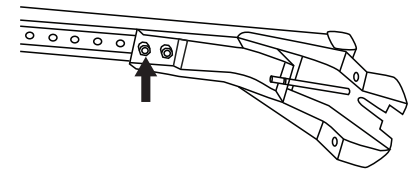
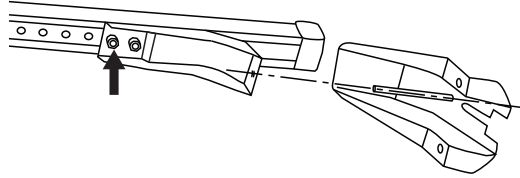
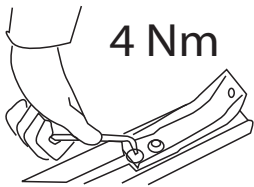

!!!



**MOCSRR0AC0010 cm 110**  
**MOCSRR0AL0006 cm 110**

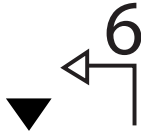
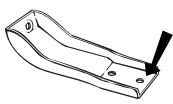

posteriore, arriere,  
rear, hinten, trasera

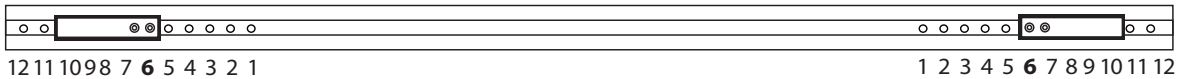
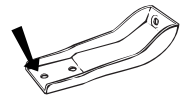
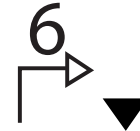

cm 43      cm 27

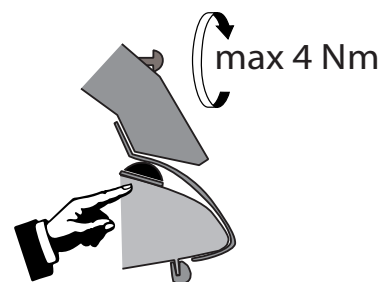
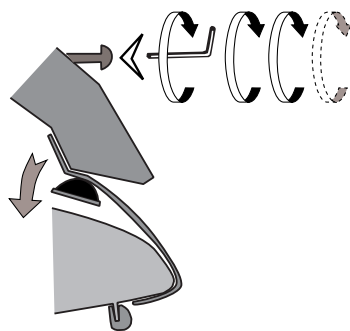
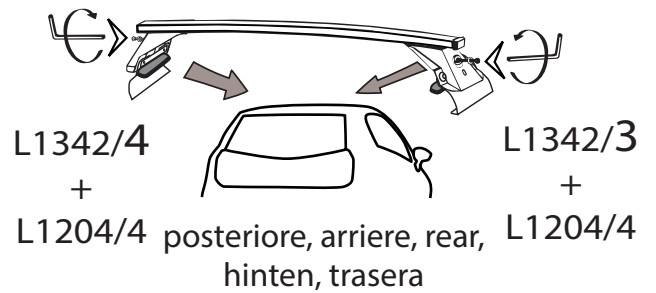
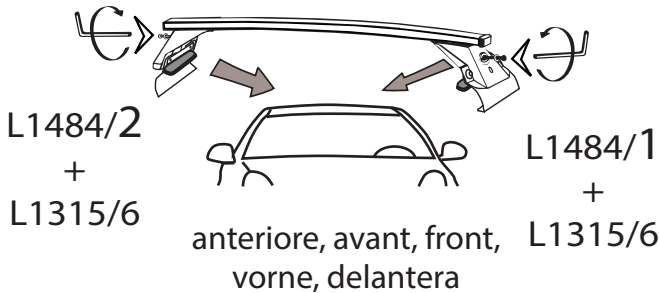
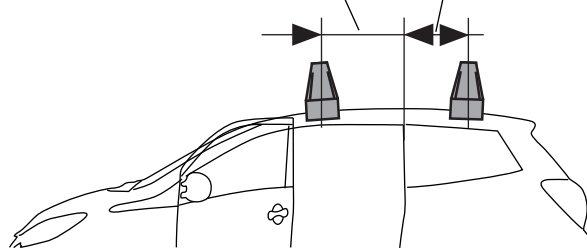

I - Per stringere, usare la chiave come indicato nel disegno. (Non si assumono responsabilità per danni causati dall'impiego di chiavi diverse da quella in dotazione al prodotto).  
F - Pour serrer, utiliser la clé comme indique ci dessous.

GB - To tighten please use the wrench as per the drawing.  
D - Zum Anziehen benutzen Sie bitte den Inbusschlüssel, nur wie auf dem Bild dargestellt.  
E - Para el correcto ajuste, utilizar la llave fija tal y como se indica en la imagen

