

# NISSAN Micra model 2017

**MOCSKT 353**

**MOCSRR0AC010 cm 110**

**MOCSRR0AL006 cm 110**



|                        |  |                          |  |             |  |                |  |
|------------------------|--|--------------------------|--|-------------|--|----------------|--|
| 1 - L1015/3<br>ant. sx |  | 1 - L1151/45<br>post. sx |  | 4 - L1204/4 |  | 8 - RCVM6X9Q   |  |
| 1 - L1015/4<br>ant. dx |  | 1 - L1151/35<br>post. dx |  | 4 - L1058/8 |  | 4 - RC20200026 |  |
|                        |  |                          |  |             |  | 1 - RCBR5      |  |

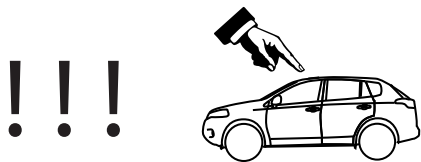
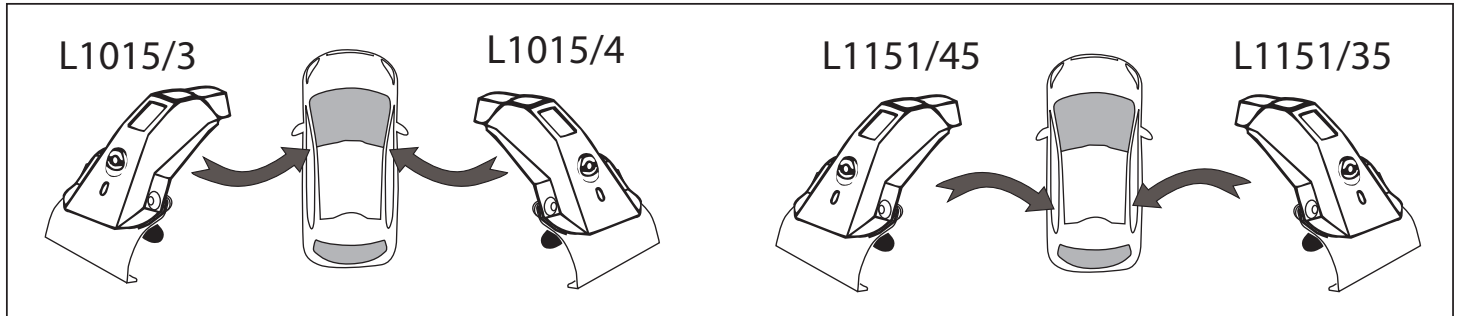
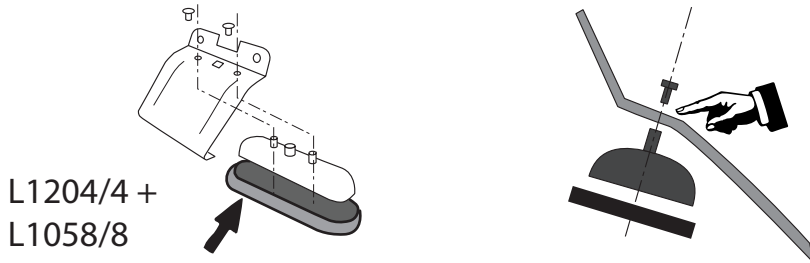

**MOCSRR0AC010 cm 110**  
**MOCSRR0AL006 cm 110**

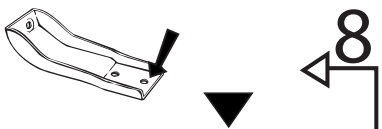

anteriore, avant, front,  
vorne, delantera

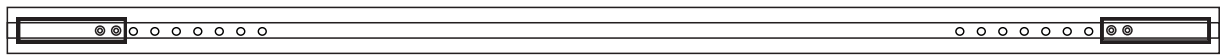
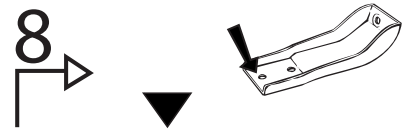

12 11 10 9 8 7 6 5 4 3 2 1

1 2 3 4 5 6 7 8 9 10 11 12

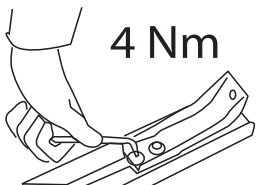

4 Nm

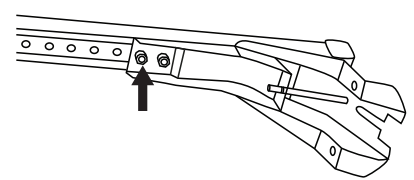
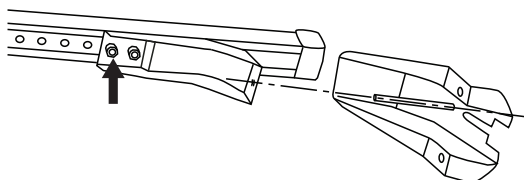

# MOC SKT 353

!!!



**MOC SRR0AC010 cm 110**  
**MOC SRR0AL006 cm 110**

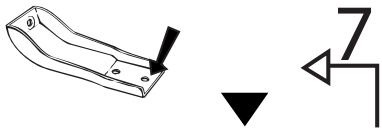

posteriore, arriere,  
 rear, hinten, trasera

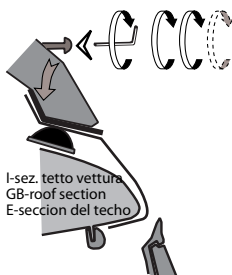
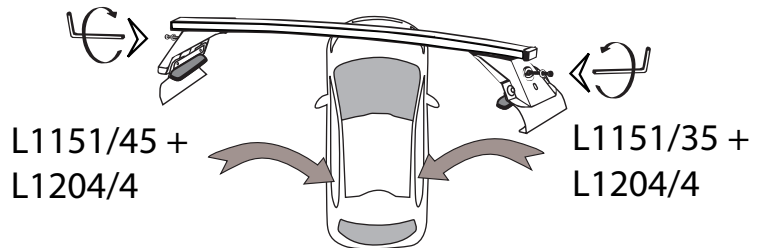
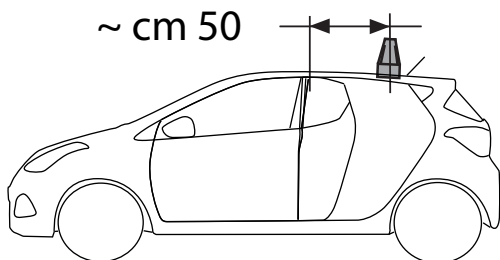
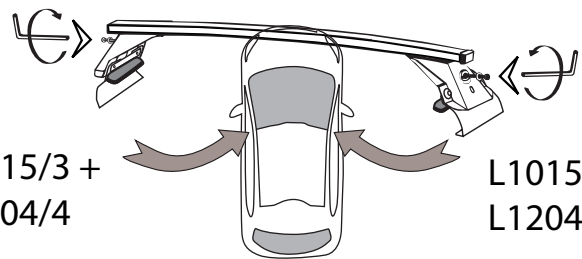
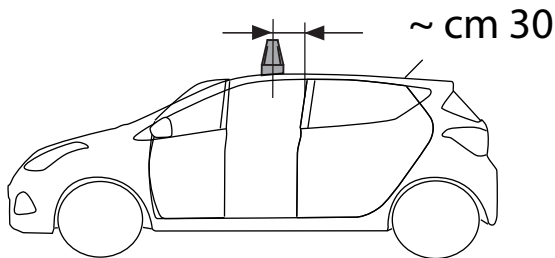
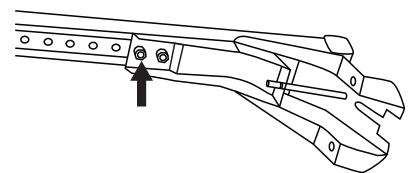
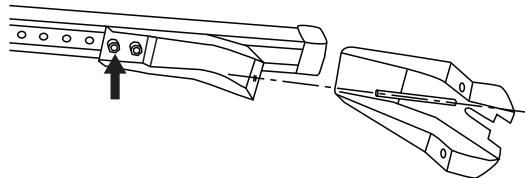
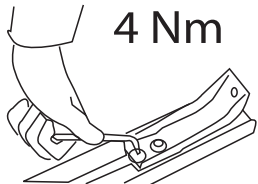
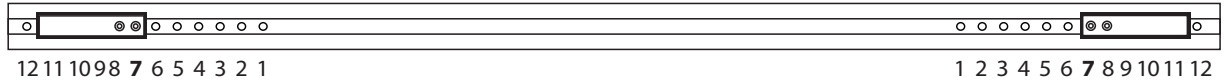
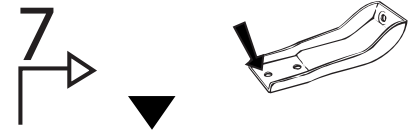

I-sez. tetto vettura  
 GB-roof section  
 E-seccion del techo

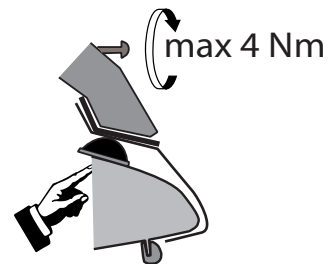

I - Per stringere, usare la chiave come indicato nel disegno. (Non si assumono responsabilità per danni causati dall'impiego di chiavi diverse da quella in dotazione al prodotto).  
 F - Pour serrer, utiliser la clé comme indiqué ci dessous.

GB - To tighten please use the wrench as per the drawing.  
 D - Zum Anziehen benutzen Sie bitte den Inbusschlüssel, nur wie auf dem Bild dargestellt.  
 E - Para el correcto ajuste, utilizar la llave fija tal y como se indica en la imagen

