

ALFA ROMEO Stelvio 2017

MOCSKT 352

MOCSRR0AC010 cm 110

MOCSRR0AL006 cm 110



1 - L1045/35 ant. sx		1 - L1463/3 post. dx		4 - L1315/6		8 - RCVM6X9Q	
1 - L1045/45 ant. dx		1 - L1463/4 post. sx		4 - L1058/7		4 - RC20200026	
						1 - RCBR5	

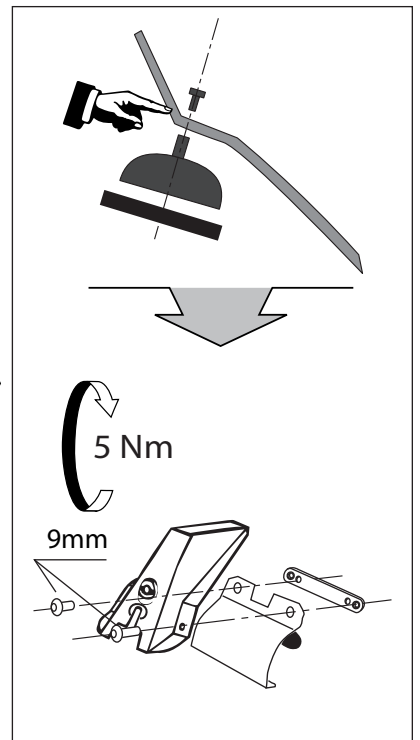
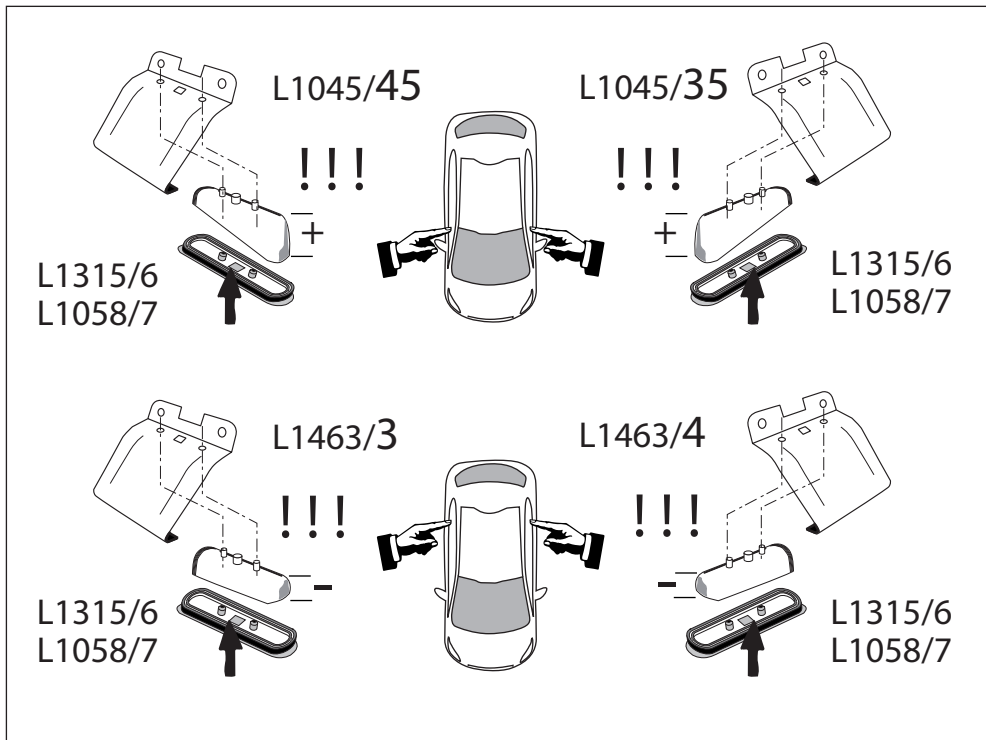

MOCSRR0AC010 cm 110
MOCSRR0AL006 cm 110

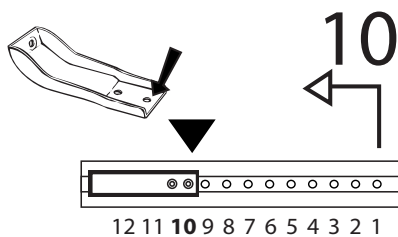

anteriore, avant, front,
vorne, delantera

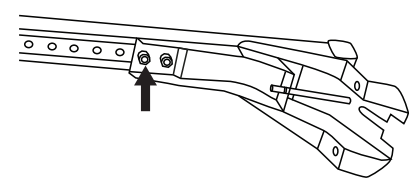
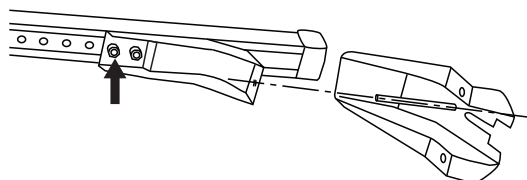
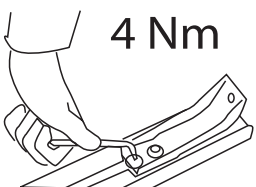
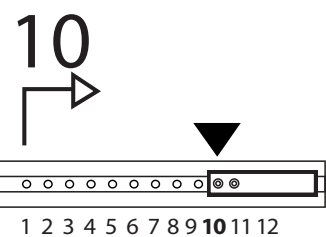

MOSKST 352

!!!



MOSRR0AC010 cm 110
MOSRR0AL006 cm 110

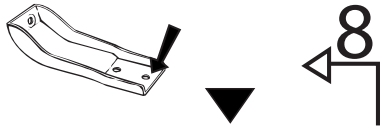

posteriore, arriere,
 rear, hinten, trasera

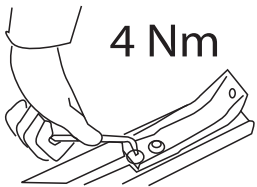
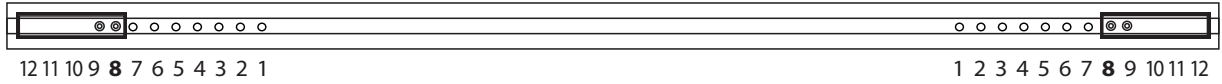
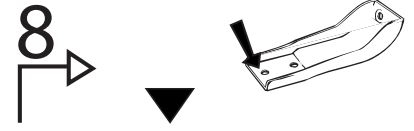

4 Nm

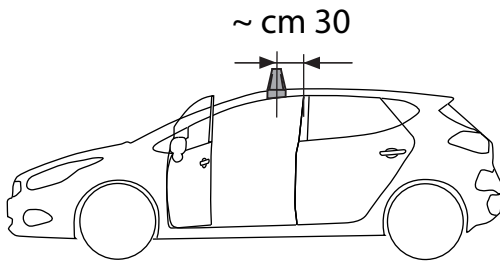
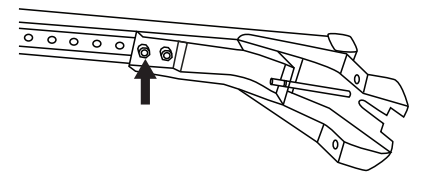
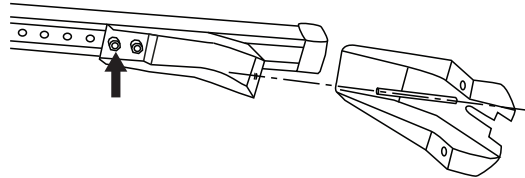

~ cm 30

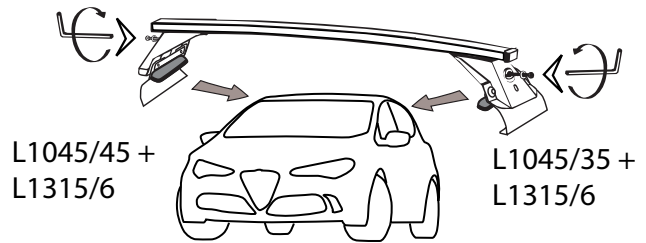

L1045/45 +
 L1315/6

L1045/35 +
 L1315/6

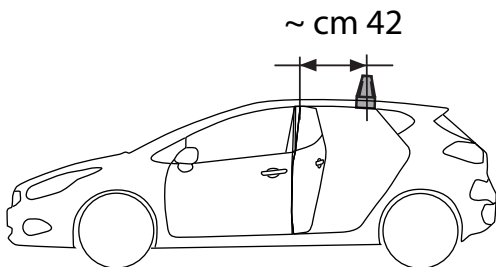

~ cm 42

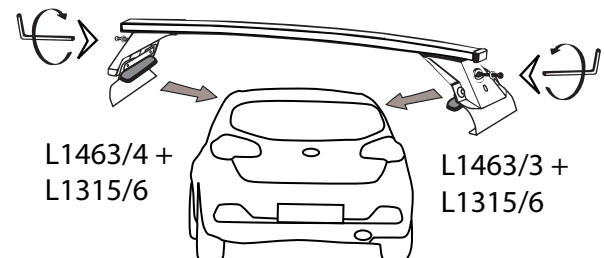

L1463/4 +
 L1315/6

L1463/3 +
 L1315/6

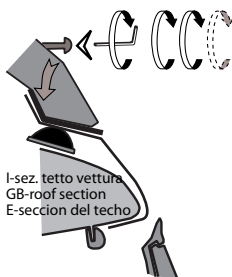

I-sez. tetto vettura
 GB-roof section
 E-seccion del techo



max 4 Nm

I - Per stringere, usare la chiave come indicato nel disegno. (Non si assumono responsabilità per danni causati dall'impiego di chiavi diverse da quella in dotazione al prodotto).
 F - Pour serrer, utiliser la clé comme indiqué ci dessous.

GB - To tighten please use the wrench as per the drawing.
 D - Zum Anziehen benutzen Sie bitte den Inbusschlüssel, nur wie auf dem Bild dargestellt.
 E - Para el correcto ajuste, utilizar la llave fija tal y como se indica en la imagen

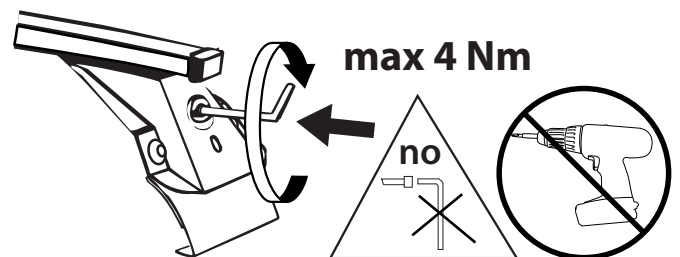

max 4 Nm

no