

# TOYOTA Hilux 2016 double cab

# MOCSKT 350

**MOCSRR0AC011 cm 124**

**MOCSRR0AL007 cm 124**

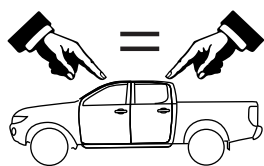
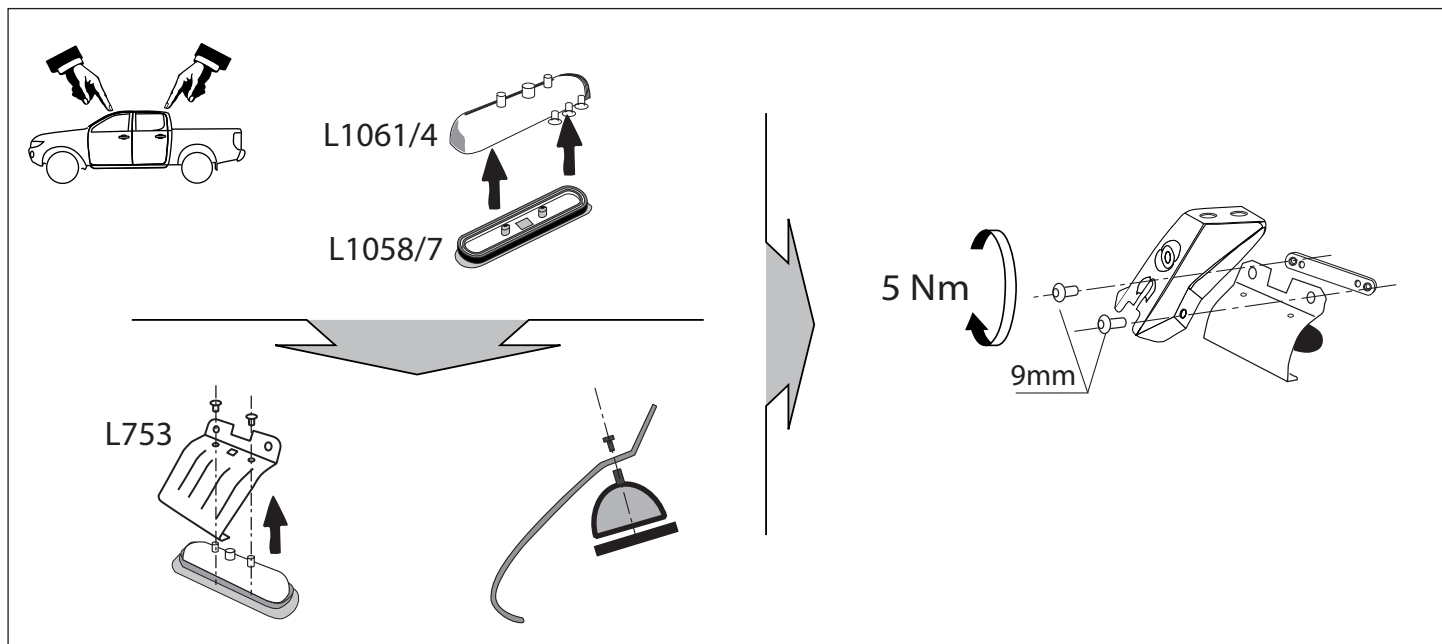
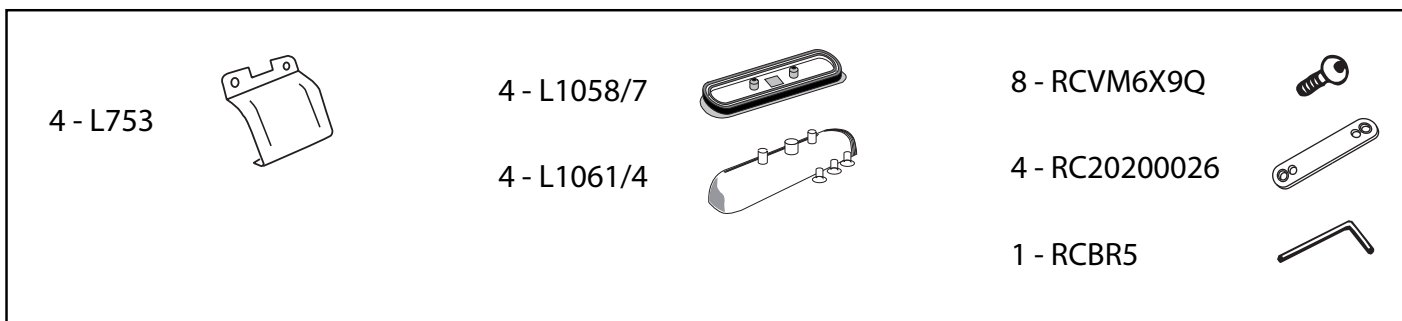

**MOCSRR0AC011 cm 124**

**MOCSRR0AL007 cm 124**

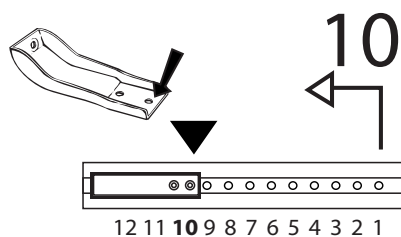

anteriore, avant, front,  
vorne, delantera

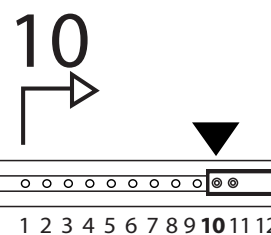

posteriore, arriere,  
rear, hinten, trasera

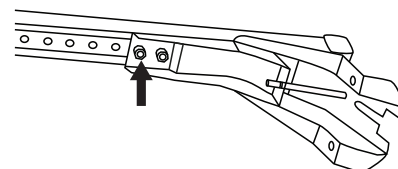
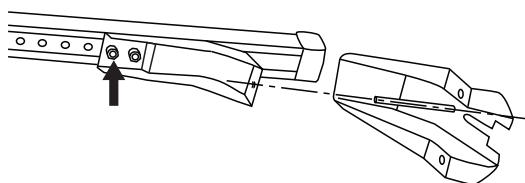
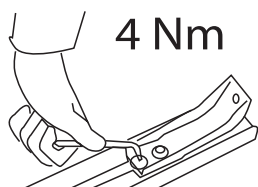

# MOCSKT 350

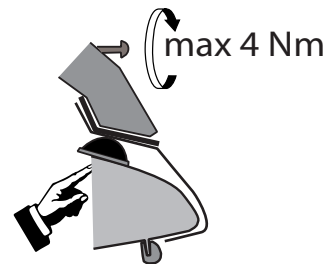
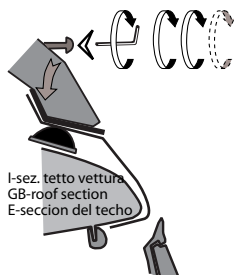
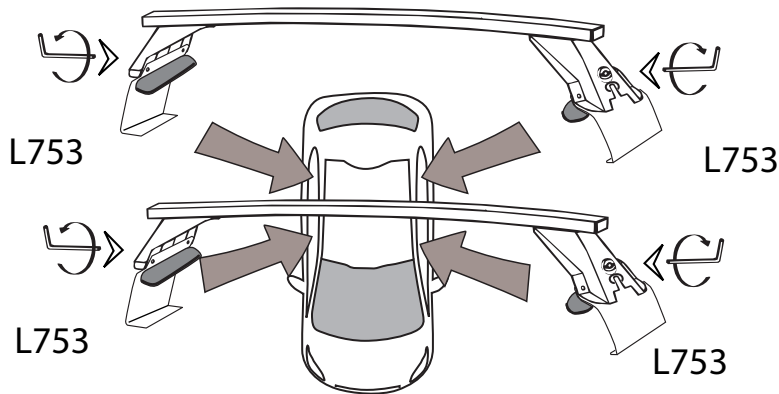
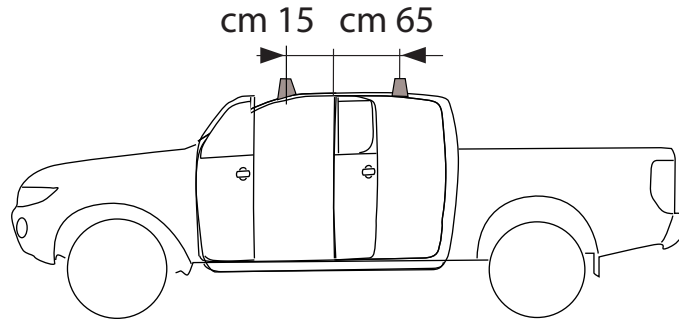
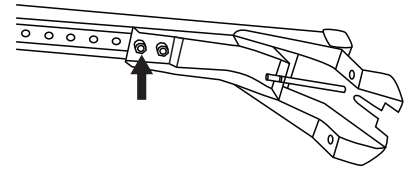
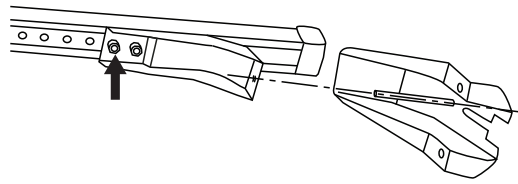
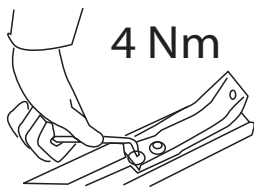

I - Per stringere, usare la chiave come indicato nel disegno. (Non si assumono responsabilità per danni causati dall'impiego di chiavi diverse da quella in dotazione al prodotto).

F - Pour serrer, utiliser la clé comme indique ci dessous.

GB - To tighten please use the wrench as per the drawing.

D - Zum Anziehen benutzen Sie bitte den Inbusschlüssel, nur wie auf dem Bild dargestellt.

E - Para el correcto ajuste, utilizar la llave fija tal y como se indica en la imagen

