

HYUNDAI i20 2014

solo tetto CRISTALLO

SUNROOF only

MOCSKT 287

MOCSRR0AC010 cm 110

MOCSRR0AL006 cm 110



1 - L1164/1 ant. sx		2 - L1110 post. dx, sx		4 - L1204/4		8 - RCVM6X9Q	
1 - L1164/2 ant. dx				4 - L1058/8		4 - RC20200026	
						1 - RCBR5	

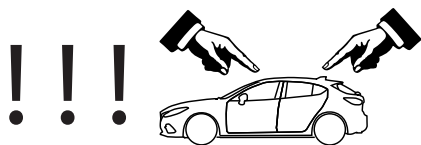
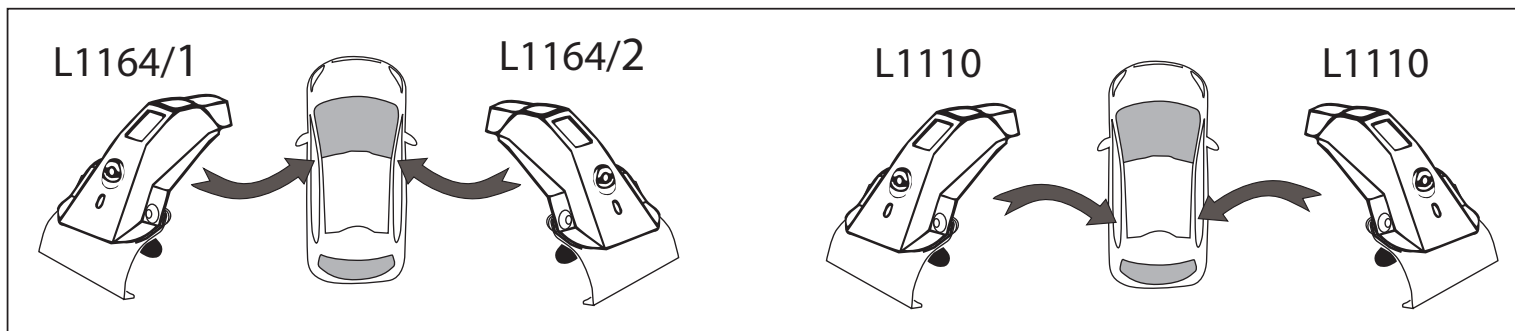
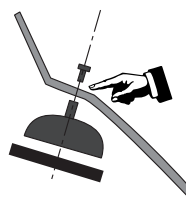
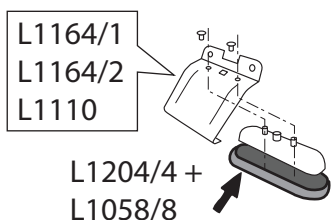

MOCSRR0AC010 cm 110
MOCSRR0AL006 cm 110

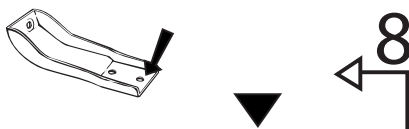

anteriore, avant, front,
vorne, delantera

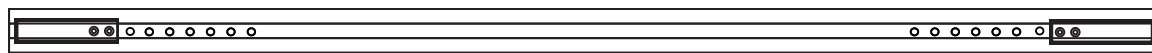
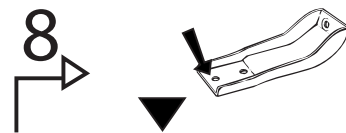

12 11 10 9 8 7 6 5 4 3 2 1

posteriore, arriere,
rear, hinten, trasera

1 2 3 4 5 6 7 8 9 10 11 12

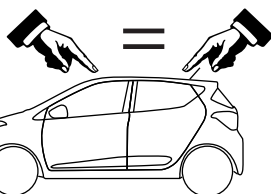

MOCSKT 287

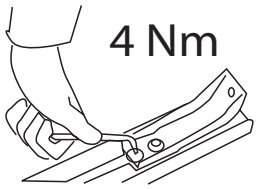

4 Nm

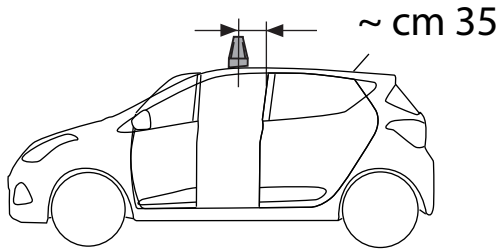
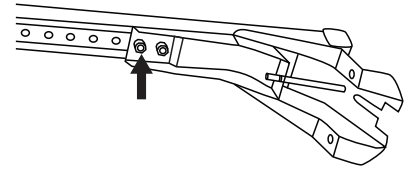
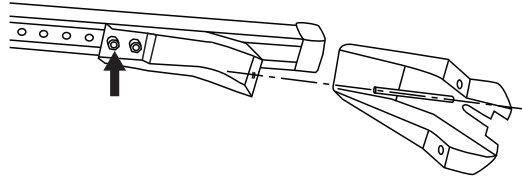

~ cm 35

L1164/1 +
L1204/4

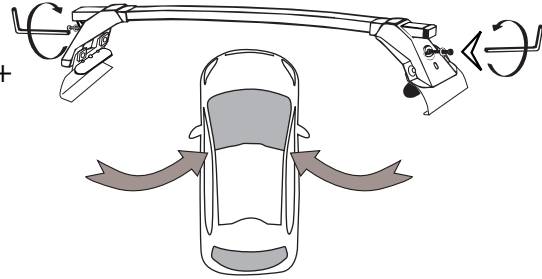

L1164/2 +
L1204/4

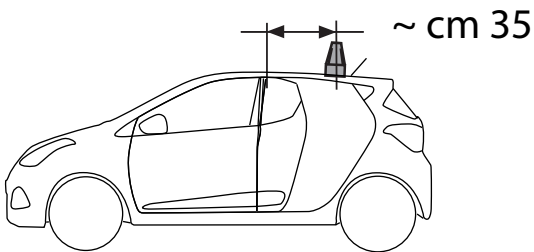

~ cm 35

L1110 +
L1204/4

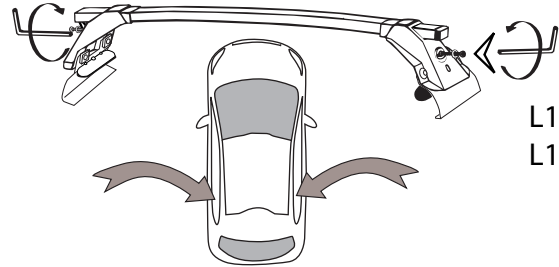

L1110 +
L1204/4

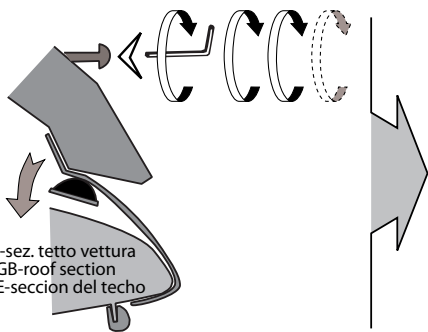

I-sez. tetto vettura
GB-roof section
E-seccion del techo

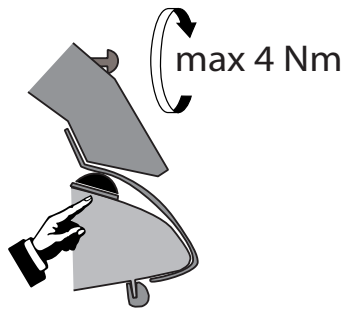

max 4 Nm

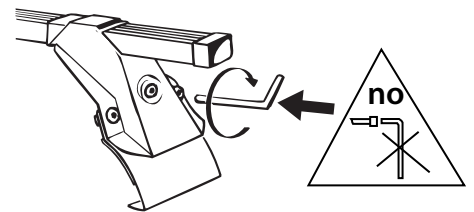

I - Per stringere, usare la chiave come indicato nel disegno. (Non si assumono responsabilità per danni causati dall'impiego di chiavi diverse da quella in dotazione al prodotto).
F - Pour serrer, utiliser la clé comme indique ci dessous.

GB - To tighten please use the wrench as per the drawing.
D - Zum Anziehen benutzen Sie bitte den Inbusschlüssel, nur wie auf dem Bild dargestellt.
E - Para el correcto ajuste, utilizar la llave fija tal y como se indica en la imagen

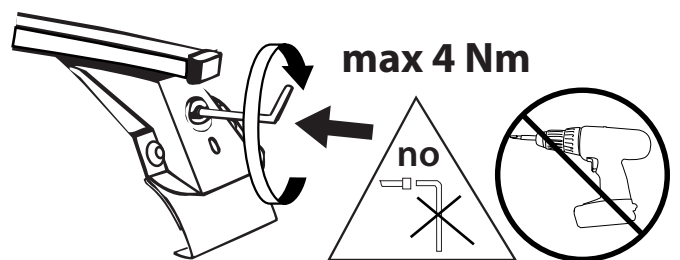

max 4 Nm

no



MODULA
case system

email: modulacs@modulacs.com
web site: www.modulacs.com

Modula s.r.l.
Loc. Penisola, 20/A
61026 Piandimeleto (PU) ITALY
phone +39 0722/700070
fax +39 0722/720017

18-01-2016