

VOLKSWAGEN Passat berlina 2014

Patent pending
MOCSKT 286

MOCSRROAC011 cm 124
MOCSRROAL007 cm 124



<p>1 - L1352/2</p> <p>1 - L1352/1</p>	<p>1 - L1367/1</p> <p>1 - L1367/2</p>	<p>4 - L1058/6</p> <p>4 - RCVM6X16TSQ</p> <p>4 - RCRD8Q</p>		<p>8 - RCVM6X9Q</p> <p>1 - RCBR5</p> <p>1 - RCBR4</p>	
---------------------------------------	---------------------------------------	---	--	---	--

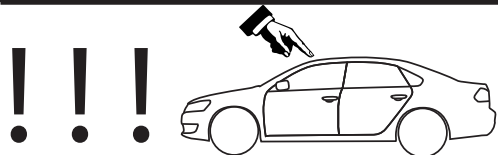
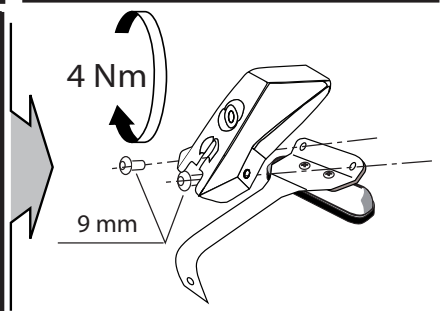
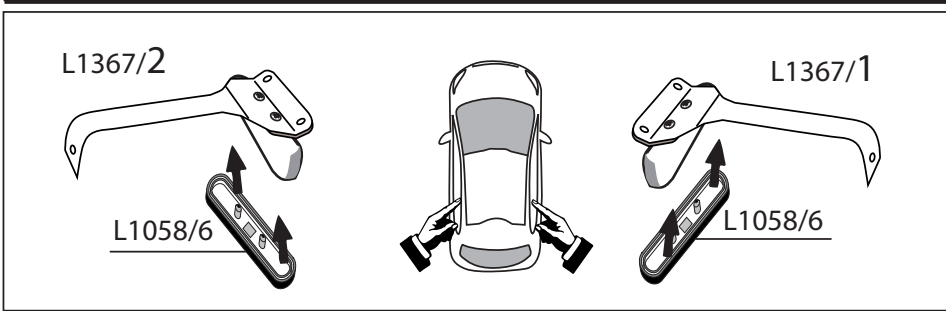
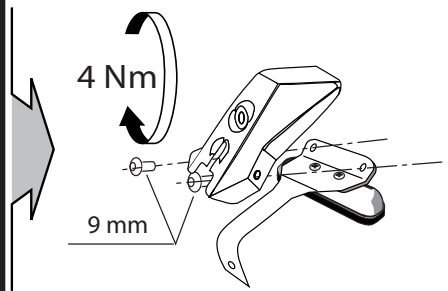
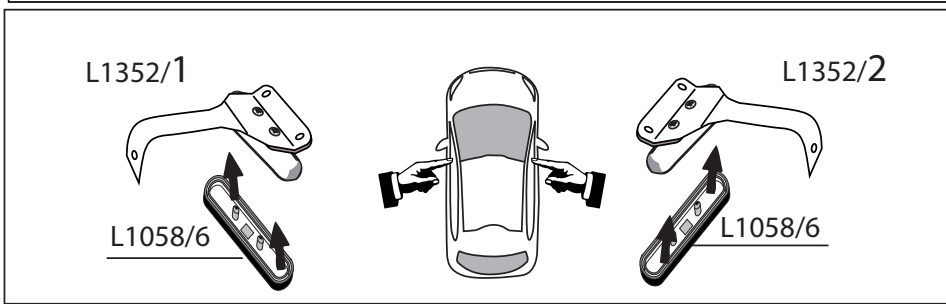

MOCSRROAC011 cm 124
MOCSRROAL007 cm 124

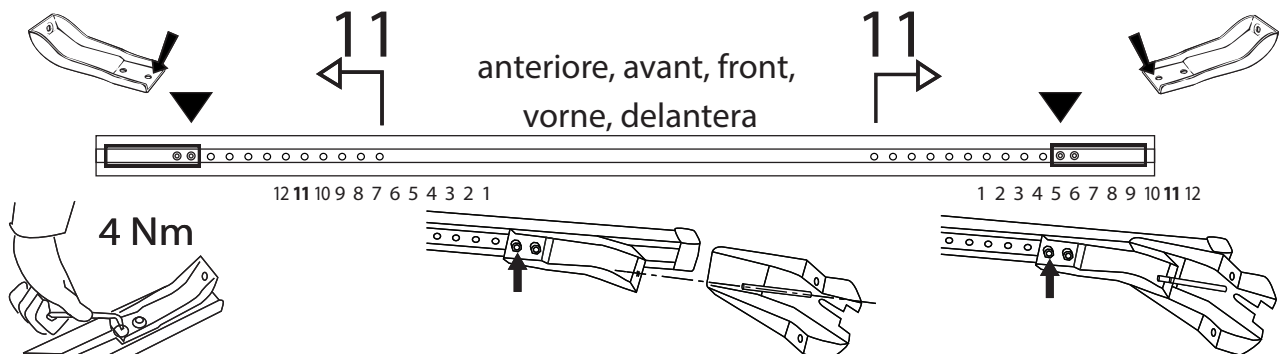

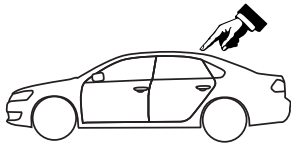

MOCSRR0AC011 cm 124
MOCSRR0AL007 cm 124

MOCSKT 286

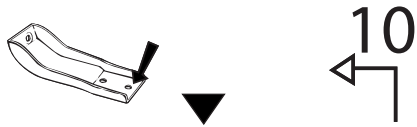

10

posteriore, arriere,
rear, hinten, trasera

10

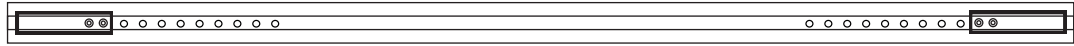
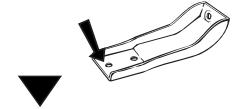

12 11 10 9 8 7 6 5 4 3 2 1

1 2 3 4 5 6 7 8 9 10 11 12

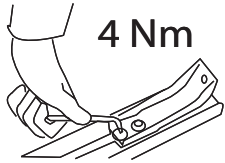

4 Nm

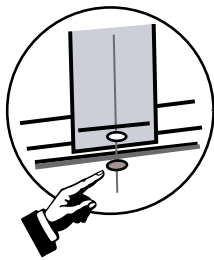
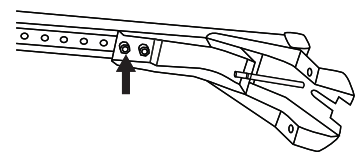
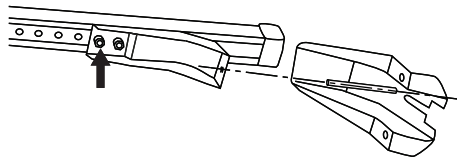

cm 74

L1352

L1367

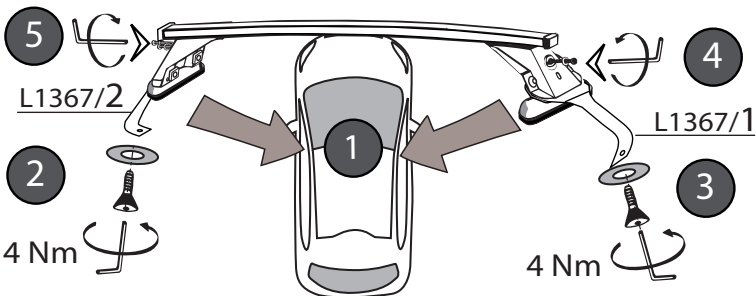
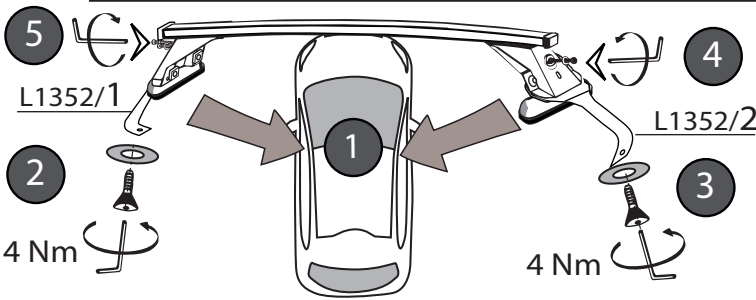
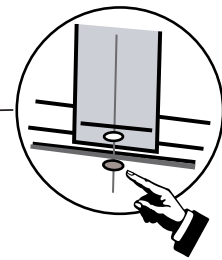
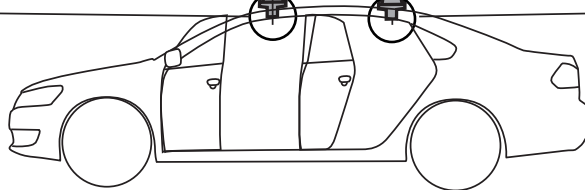

I-sez. tetto vettura
GB-roof section
E-seccion del techo

RCRD8Q
RCVM6X16TSQ



I-sez. tetto vettura
GB-roof section
E-seccion del techo



max 4 Nm

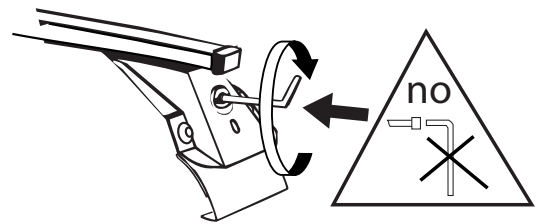

MODULA
case system

email: modulacs@modulacs.com
web site: www.modulacs.com

Modula s.r.l.
Loc. Penisola, 20/A
61026 Piandimeleto (PU) ITALY
phone +39 0722/700070
fax +39 0722/720017

18-01-2016