

NISSAN Qashqai II 2013

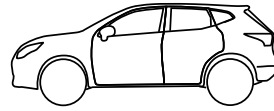

Patent pending
MOCSKT 274

MOCSRROAC011 cm 124
MOCSRROAL007 cm 124



<p>1 - L1327/2</p> <p>1 - L1327/1</p>	<p>4 - L1058/6</p> <p>4 - RCVM5X12Q</p> <p>4 - RCRD8Q</p>	<p>8 - RCVM6X9Q</p> <p>1 - RCBR5</p> <p>1 - RCBR3</p>
<p>2 - L1338/3</p>		

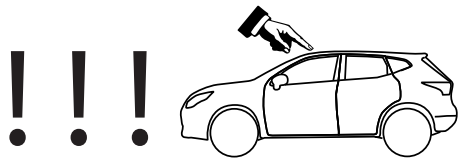
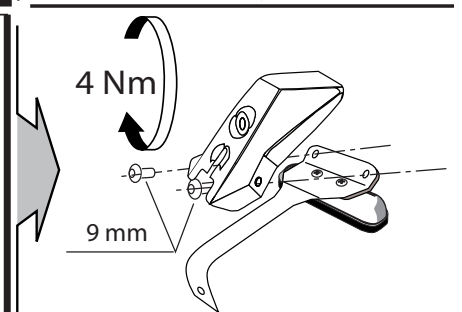
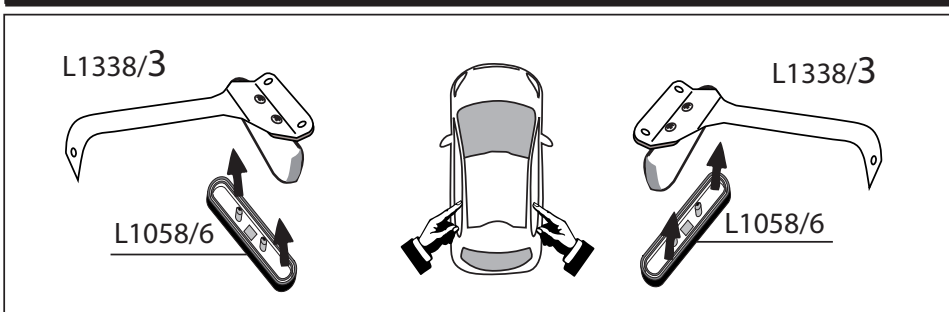
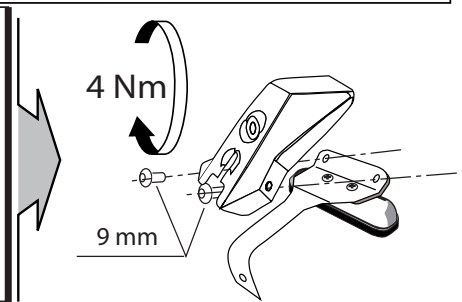
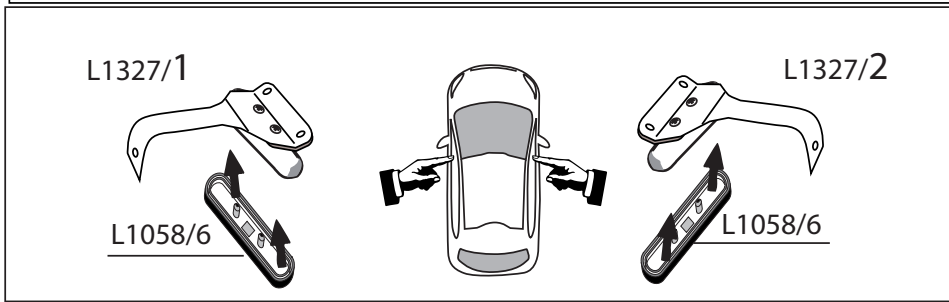

MOCSRROAC011 cm 124
MOCSRROAL007 cm 124

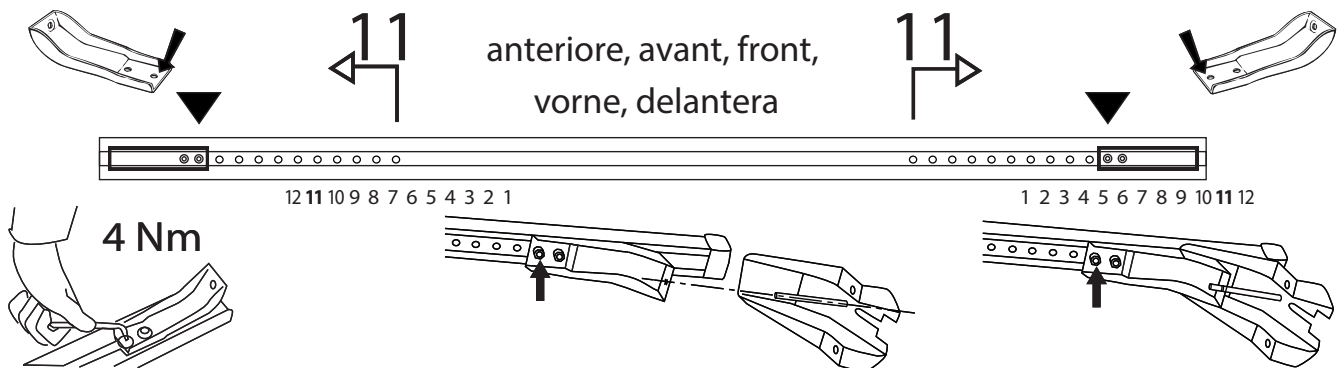

!!!

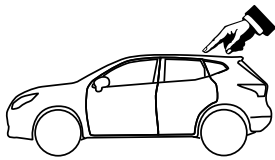

MOCSRROAC011 cm 124
MOCSRROAL007 cm 124

MOCSKT 274

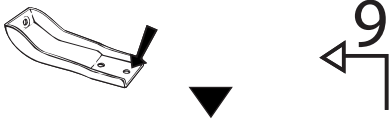

posteriore, arriere,
 rear, hinten, trasera

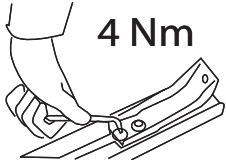
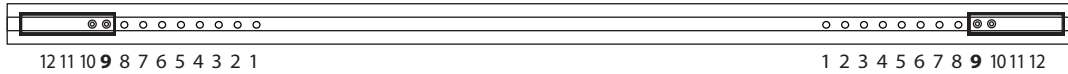
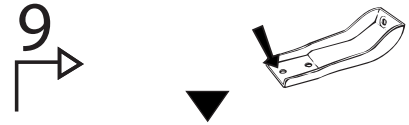

4 Nm

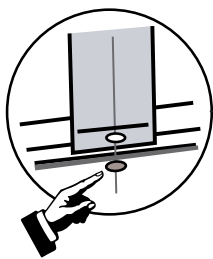
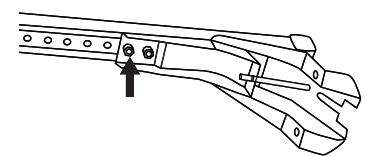
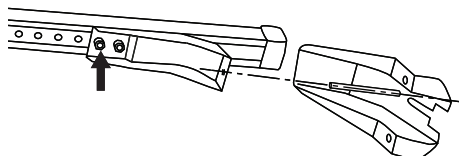

L1327/1
 L1327/2

cm 37 cm 36

L1338/3

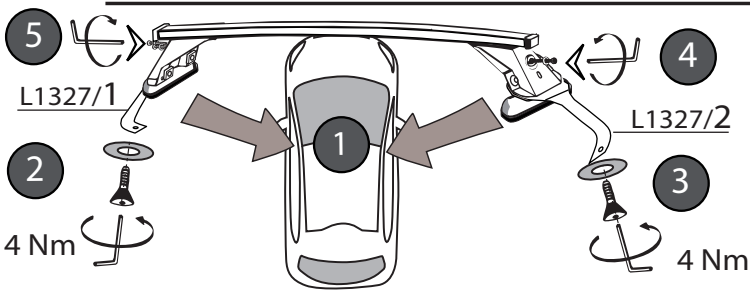
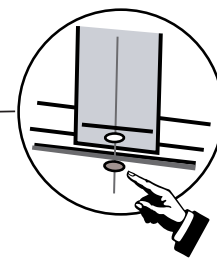
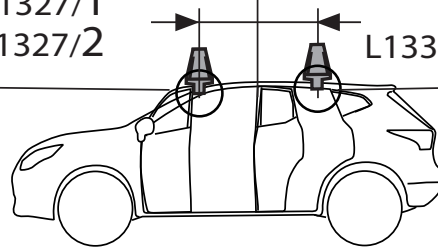

2

4 Nm

3

4 Nm

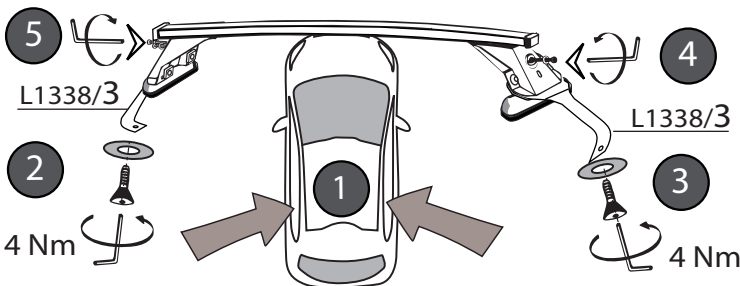

2

4 Nm

3

4 Nm

I-sez. tetto vettura
 GB-roof section
 E-seccion del techo

RCRD8Q

RCVM5X12Q

I-sez. tetto vettura
 GB-roof section
 E-seccion del techo



max 4 Nm

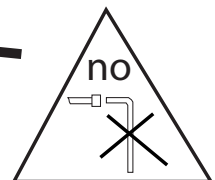
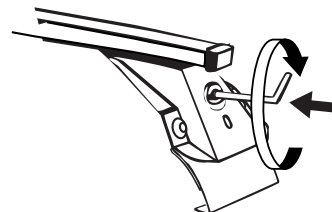

MODULA
 case system

email: modulacs@modulacs.com
 web site: www.modulacs.com

Modula s.r.l.
 Loc. Penisola, 20/A
 61026 Piandimeleto (PU) ITALY
 phone +39 0722/700070
 fax +39 0722/720017

18-01-2016