

HYUNDAI i10 2013

MOCSKT 268

MOCSRR0AC010 cm 110

MOCSRR0AL006 cm 110



2 - L1169/16 ant. sx post. dx		4 - L1058/5		4 - RCVM6X9Q	
2 - L1169/26 ant. dx post. sx		4 - RC20011935		4 - RC20200026	
4 - L1204/4		4 - RCVM6X13Q		1 - RCBR5	

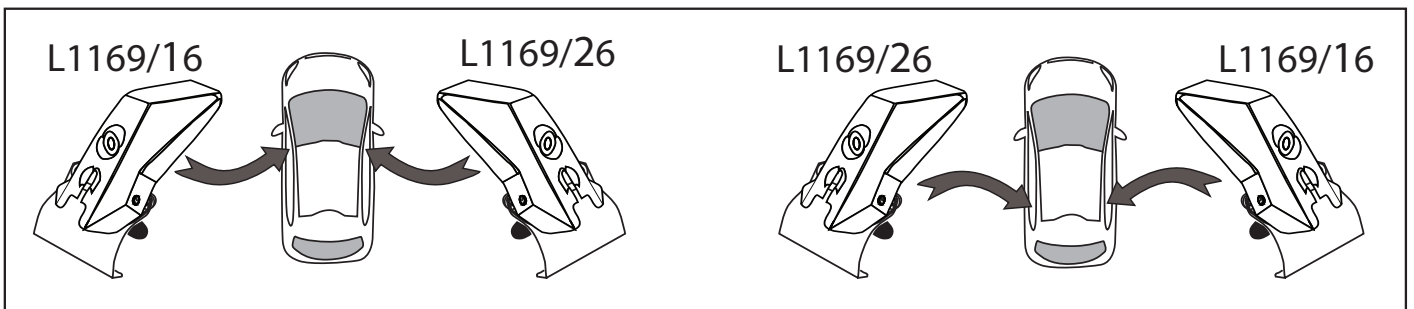
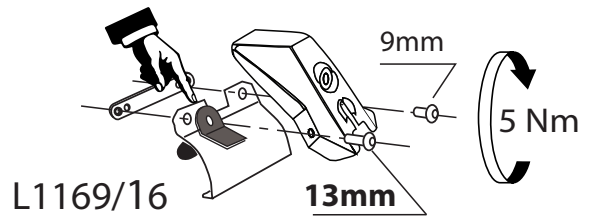
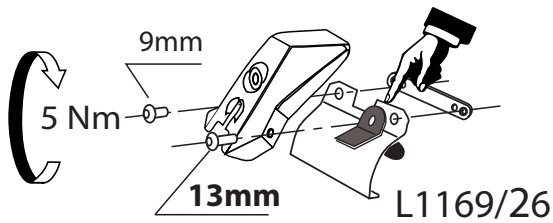
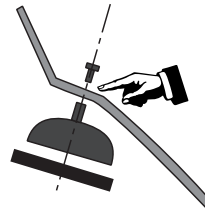
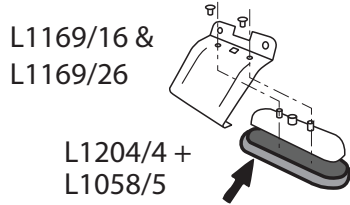

MOCSRR0AC010 cm 110 - MOCSRR0AL006 cm 110

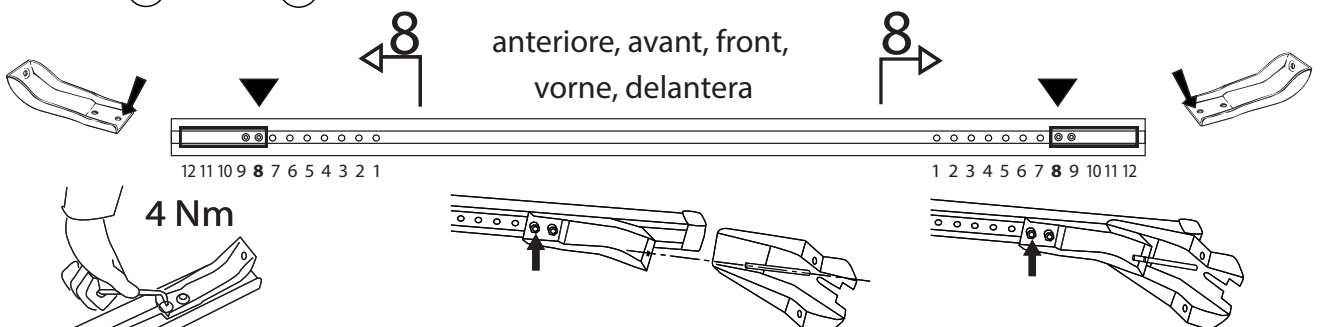

MOCSKT 268



MOCSRR0AC010 cm 110
MOCSRR0AL006 cm 110

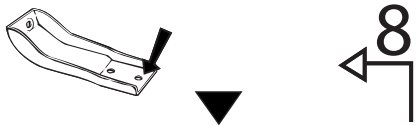

posteriore, arriere,
 rear, hinten, trasera

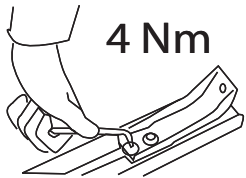
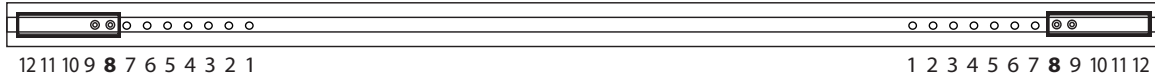
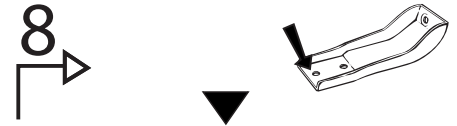

4 Nm

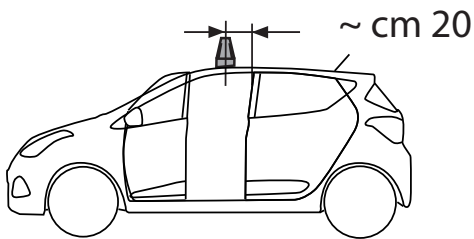
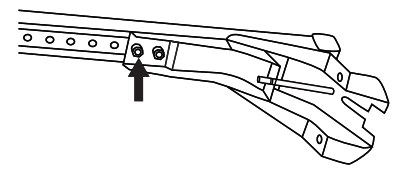
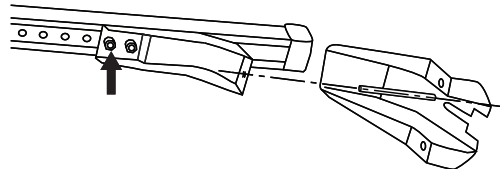

~ cm 20

L1169/16 +
 L1204/4

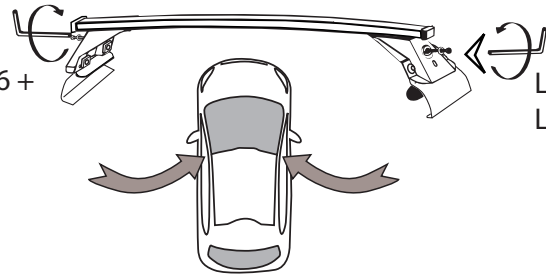

L1169/26 +
 L1204/4

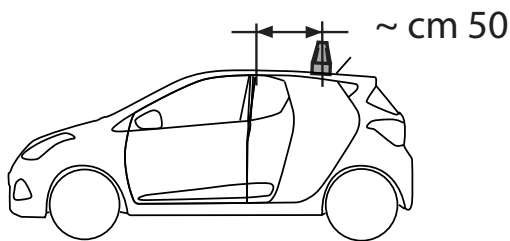

~ cm 50

L1169/26 +
 L1204/4

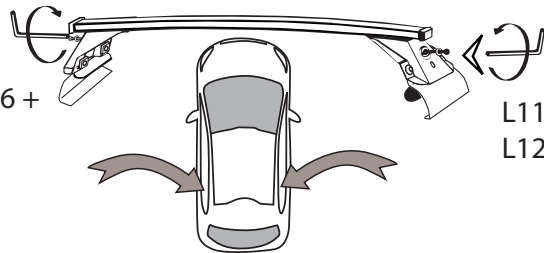

L1169/16 +
 L1204/4

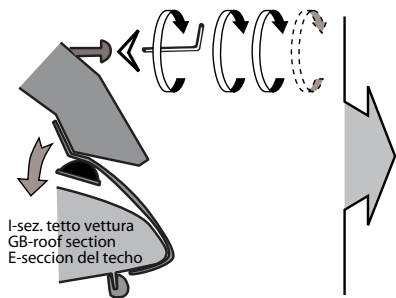

I-sez. tetto vettura
 GB-roof section
 E-seccion del techo

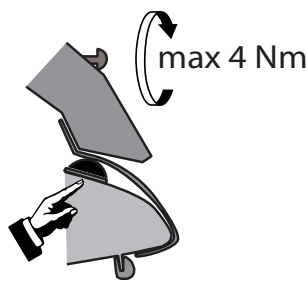

max 4 Nm

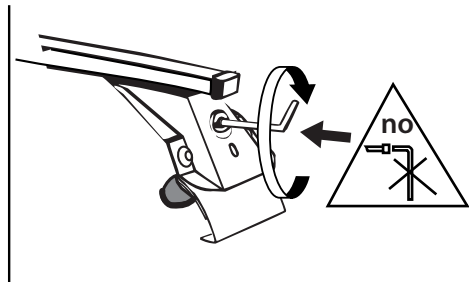

I - Per stringere, usare la chiave come indicato nel disegno.
 (Non si assumono responsabilità per danni causati dall'impiego di chiavi diverse da quella in dotazione al prodotto).
 F - Pour serrer, utiliser la clé comme indiqué ci dessus.

GB - To tighten please use the wrench as per the drawing.
 D - Zum Anziehen benutzen Sie bitte den Inbusschlüssel, nur wie auf dem Bild dargestellt.
 E - Para el correcto ajuste, utilizar la llave fija tal y como se indica en la imagen