

RENAULT Captur model 2013

Patent pending
MOCSKT 257

MOCSRROAC010 cm 110

MOCSRROAL006 cm 110



<p>1 - L1328/4</p> <p>1 - L1328/3</p>	<p>4 - L1058/6</p> <p>4 - RCVM6X16TSQ</p> <p>16 mm</p>	<p>8 - RCVM6X9Q</p> <p>1 - RCBR5</p> <p>1 - RCBR4</p>
<p>1 - L1314/2</p> <p>1 - L1314/2</p>	<p>4 - RCRD8Q</p>	

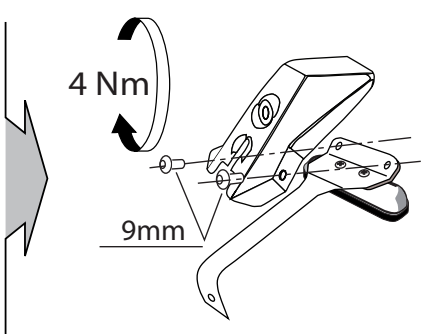
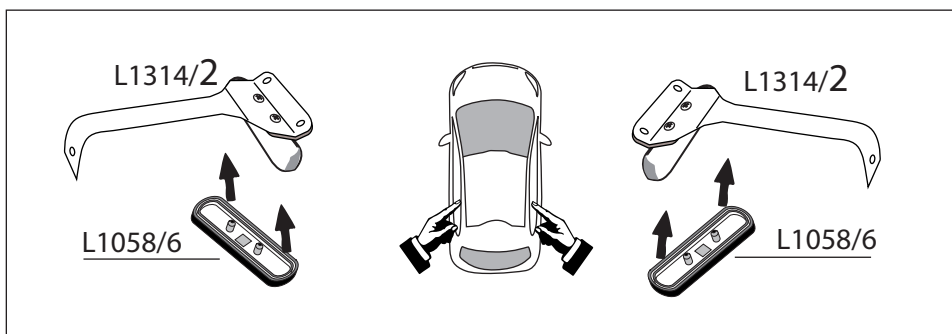
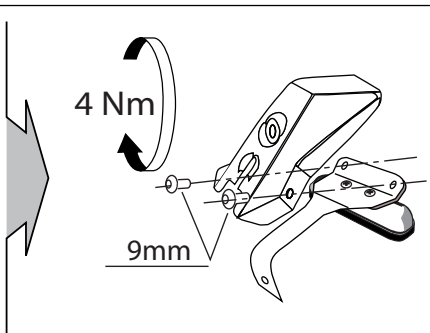
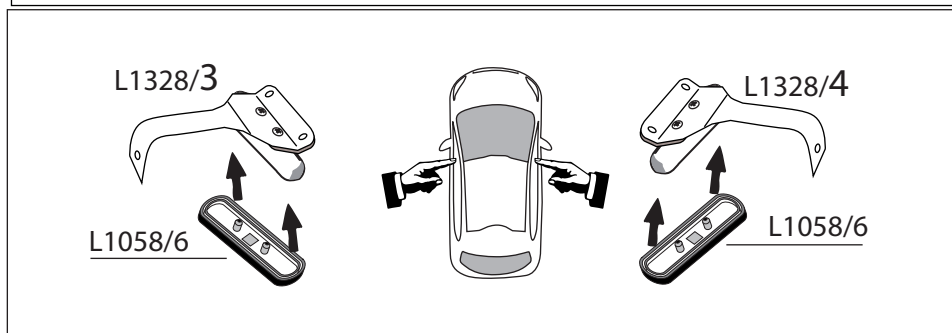

MOCSRROAC010 cm 110 - MOCSRROAL006 cm 110

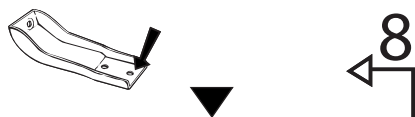

anteriore, avant, front,
vorne, delantera

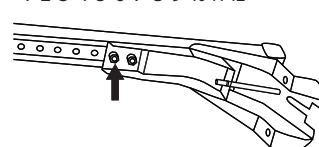
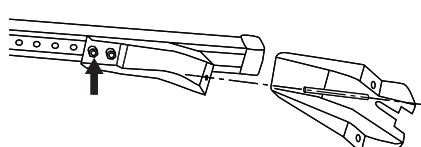
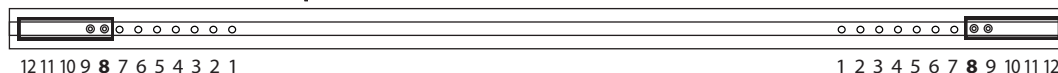
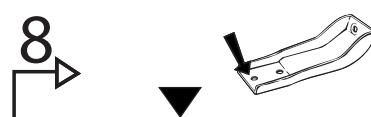



MOCRR0AC010 cm 110
MOCRR0AL006 cm 110

MOCSKT 257

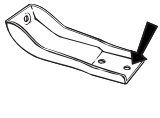

posteriore, arriere,
rear, hinten, trasera

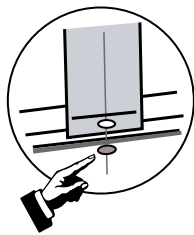
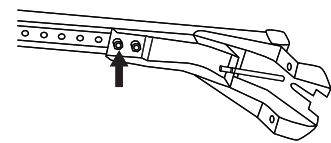
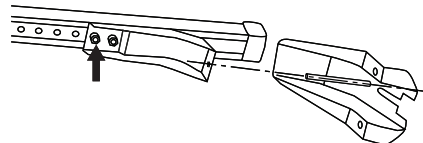
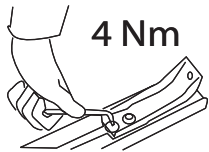
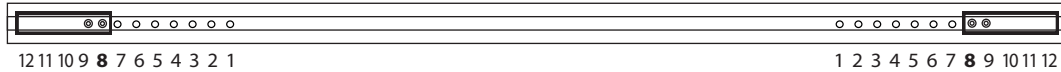
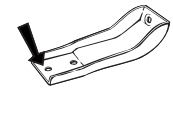

L1328/3
L1328/4

cm 76

L1314/2

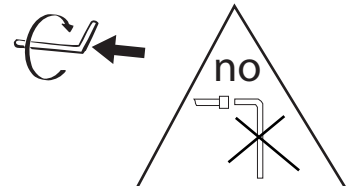
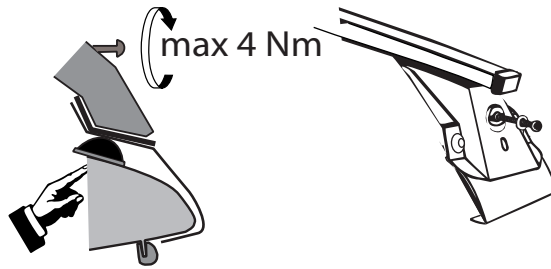
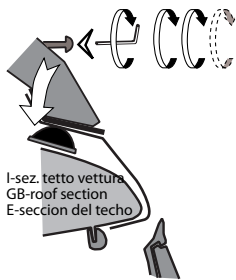
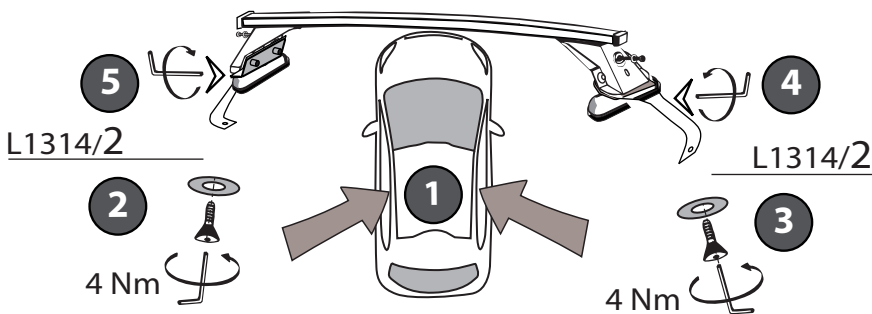
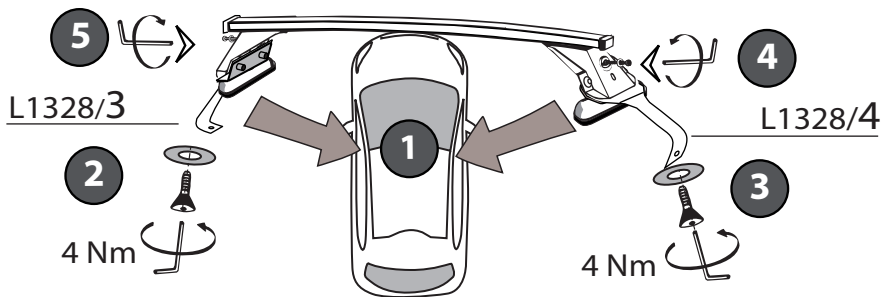
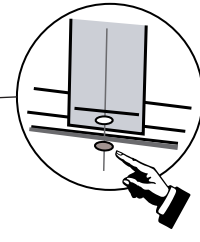
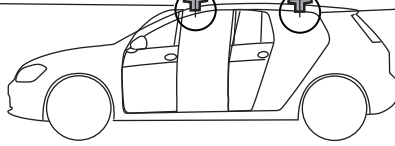

MODULA
case system

email: modulacs@modulacs.com
web site: www.modulacs.com

Modula s.r.l.
Loc. Penisola, 20/A
61026 Piandimeleto (PU) ITALY
phone +39 0722/700070
fax +39 0722/720017

18-01-2016