

TOYOTA RAV4 2013

MOC SKT 255



MOC SRR0AC010 cm 110

MOC SRR0AL006 cm 110

2 - L868 ant 	1 - L1342/4 post sx 	4 - L1204/4 	8 - RCVM6X9Q
1 - L1342/3 post dx 	4 - L1058/5 	4 - RC20200026 	1 - RCBR5

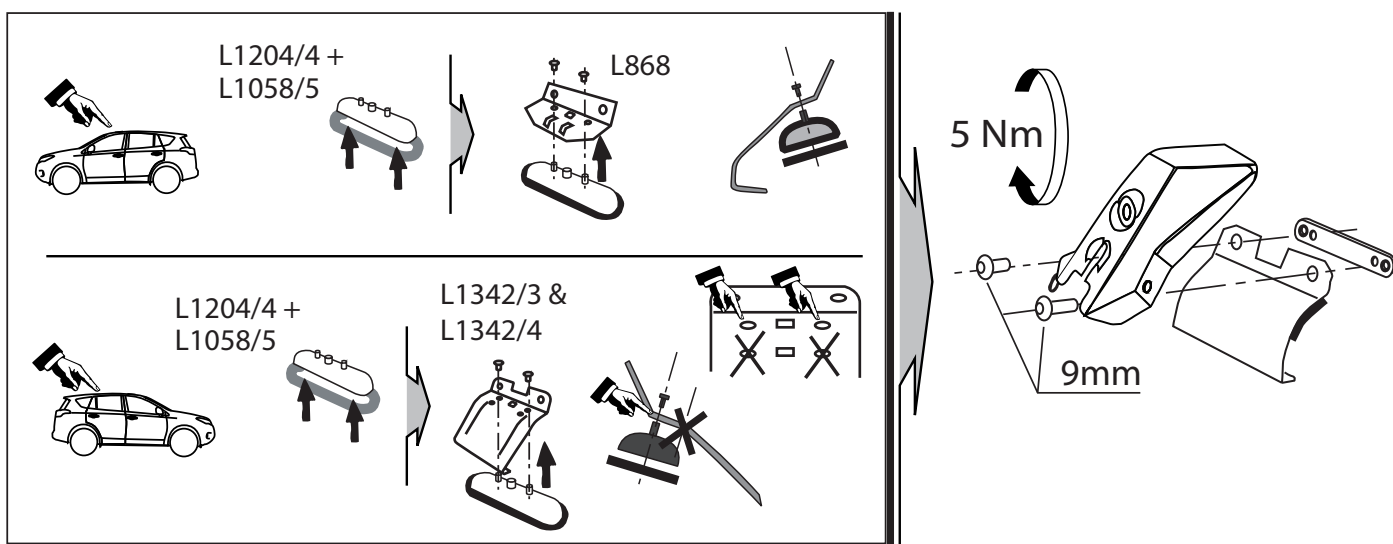

MOC SRR0AC010 cm 110 MOC SRR0AL006 cm 110

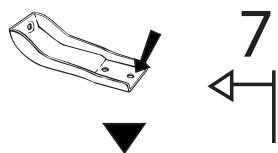

anteriore, avant, front, vorne, delantera

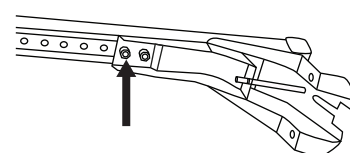
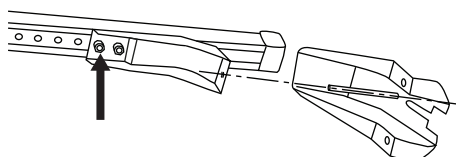
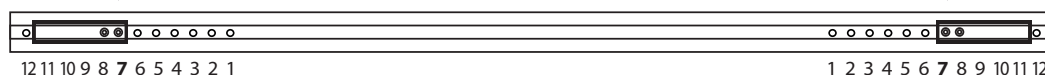
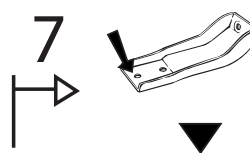

MOSKST 255



MOSRROAC010 cm 110

MOSRROAL006 cm 110

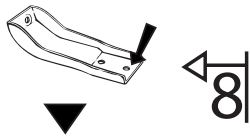

posteriore, arriere,
rear, hinten, trasera

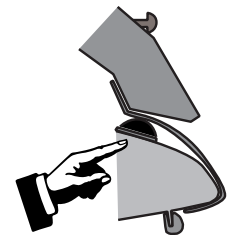
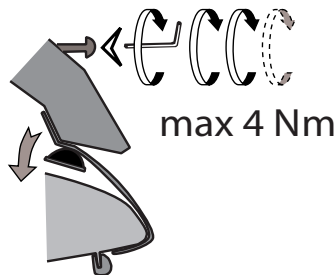
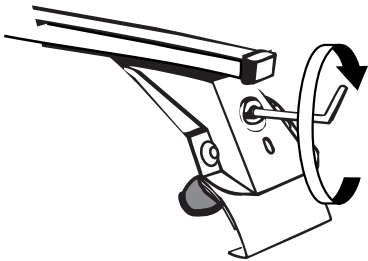
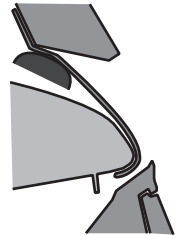
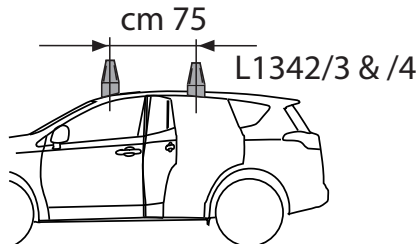
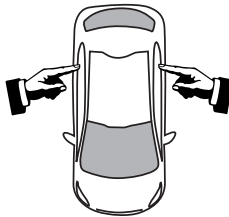
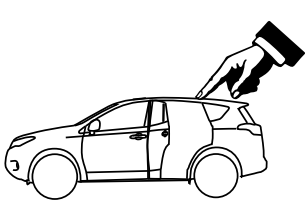
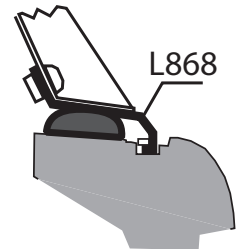
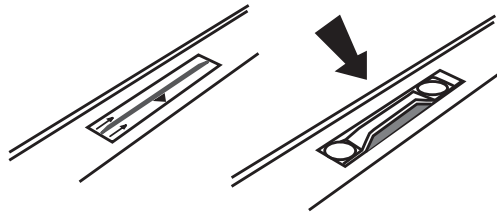
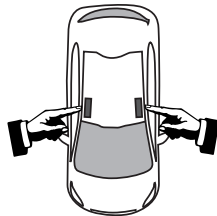
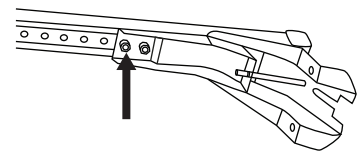
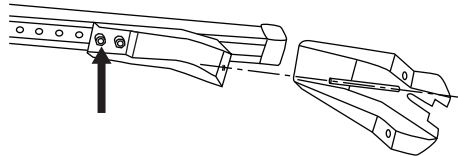
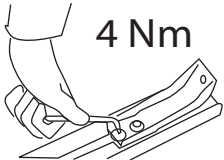
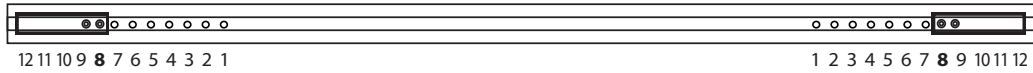
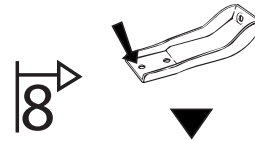

I - Per stringere, usare la chiave come indicato nel disegno. (Non si assumono responsabilità per danni causati dall'impiego di chiavi diverse da quella in dotazione al prodotto).
F - Pour serrer, utiliser la clé comme indique ci dessous.

GB - To tighten please use the wrench as per the drawing.
D - Zum Anziehen benutzen Sie bitte den Inbusschlüssel, nur wie auf dem Bild dargestellt.
E - Para el correcto ajuste, utilizar la llave fija tal y como se indica en la imagen

