

# BMW serie 3 Touring 2012 no rails

# MOCSKT 240

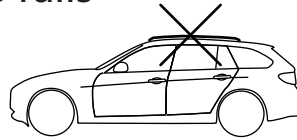

**MOCSRR0AC010 cm 110**  
**MOCSRR0AL006 cm 110**



1 - L1240/3 ant. sx 	2 - L599/3 post 	4 - L1058/5 	8 - RCVM6X9Q 
1 - L1240/4 ant. dx 	4 - L1204/4 	4 - RC20200026 	1 - RCBR5 

L1240/3  
L1240/4

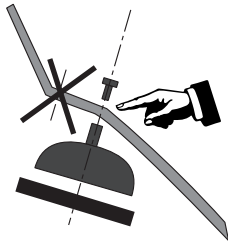
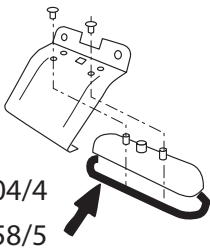

L599/3

L1204/4  
+ L1058/5

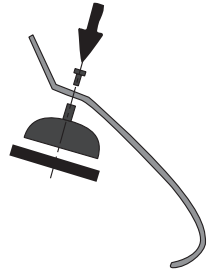
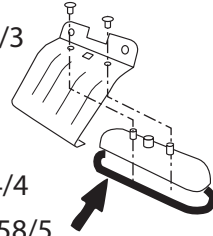

 4 Nm 9 mm L1240/4		 4 Nm 9 mm L1240/3
 4 Nm 9 mm L599/3		 4 Nm 9 mm L599/3



**MOCSRR0AC010 cm 110 - MOCSRR0AL006 cm 110**

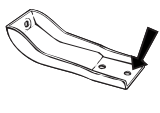

anteriore, avant, front,  
vorne, delantera

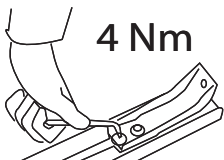
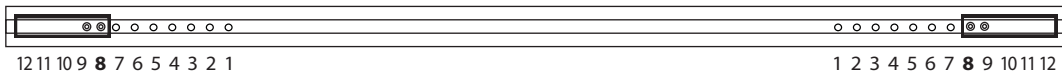
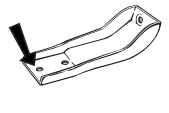

4 Nm

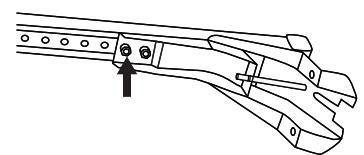
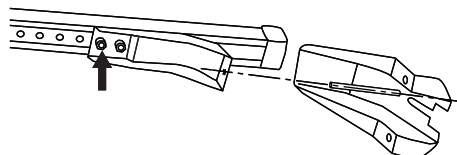

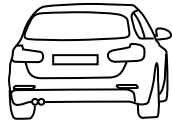

**MOCSRR0AC010 cm 110**  
**MOCSRR0AL006 cm 110**

**MOCSKT 240**

posteriore, arriere,  
 rear, hinten, trasera

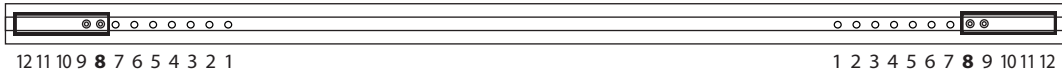
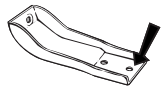

1 2 3 4 5 6 7 8 9 10 11 12

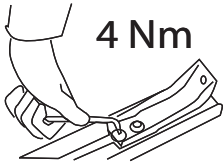

4 Nm

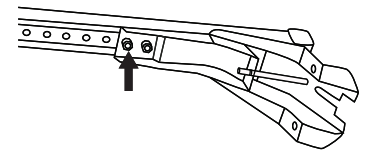
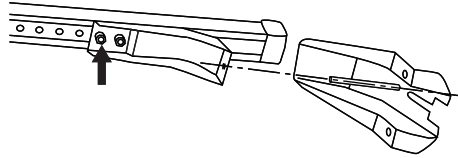

cm 30

cm 45

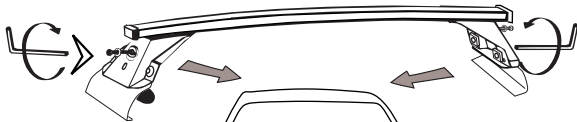
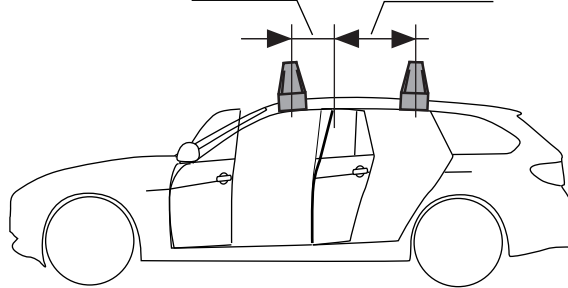

L1240/4  
 + L1204/4

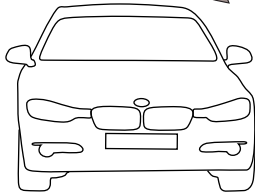

L1240/3  
 + L1204/4



L599/3  
 + L1204/4

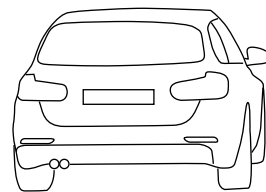

L599/3  
 + L1204/4

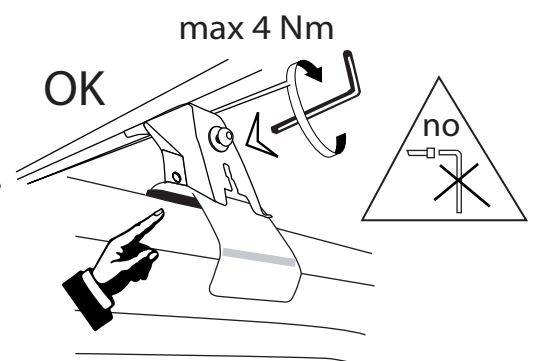
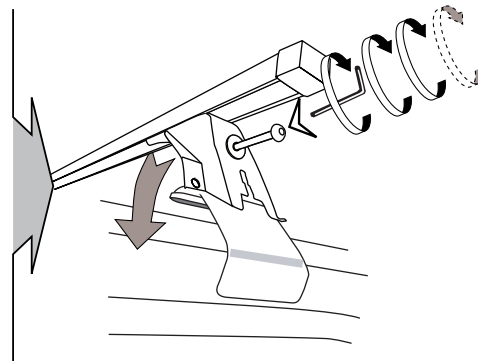
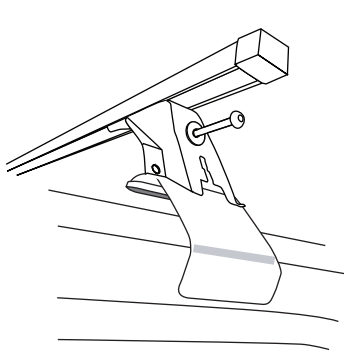

I - Per stringere, usare la chiave come indicato nel disegno. (Non si assumono responsabilità per danni causati dall' impiego di chiavi diverse da quella in dotazione al prodotto).

F - Pour serrer, utiliser la clé comme indique ci dessous.

GB - To tighten please use the wrench as per the drawing.

D - Zum Anziehen benutzen Sie bitte den Inbusschlüssel, nur wie auf dem Bild dargestellt.

E - Para el correcto ajuste, utilizar la llave fija tal y como se indica en la imagen



**MODULA**  
 case system

email: [modulacs@modulacs.com](mailto:modulacs@modulacs.com)  
 web site: [www.modulacs.com](http://www.modulacs.com)

Modula s.r.l.  
 Loc. Penisola, 20/A  
 61026 Piandimeleto (PU) ITALY  
 phone +39 0722/700070  
 fax +39 0722/720017

18-01-2016