

FORD B-Max model 2012

MOCSKT 235

MOCSRR0AC011 cm 124

MOCSRR0AL007 cm 124



| | | | | | | | |
|------------------------|--|---------------------|--|----------------------|--|----------------|--|
| 1 - L887/1 ant. sx. | | 2 - L1064 post. | | 2 - L1061/4 17 mm | | 8 - RCVM6X9Q | |
| 1 - L887/2 ant. dx. | | 2 - L1204/4 5 mm | | 2 - L1058/5 | | 4 - RC20200026 | |
| | | | | 2 - L1058/6 | | 1 - RCBR5 | |

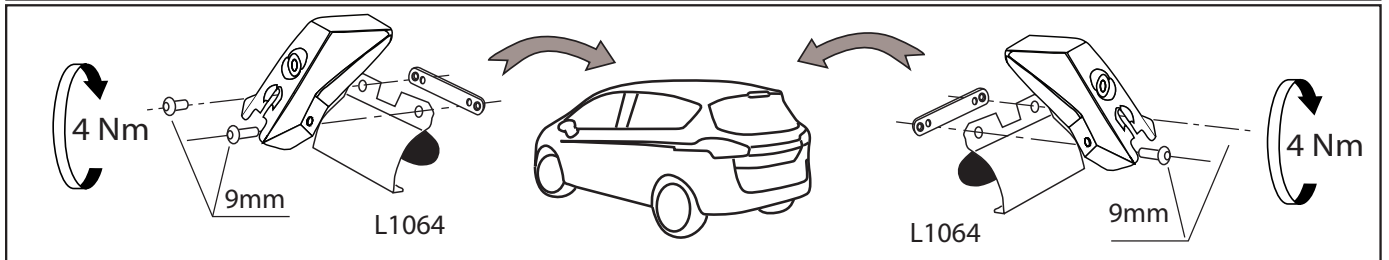
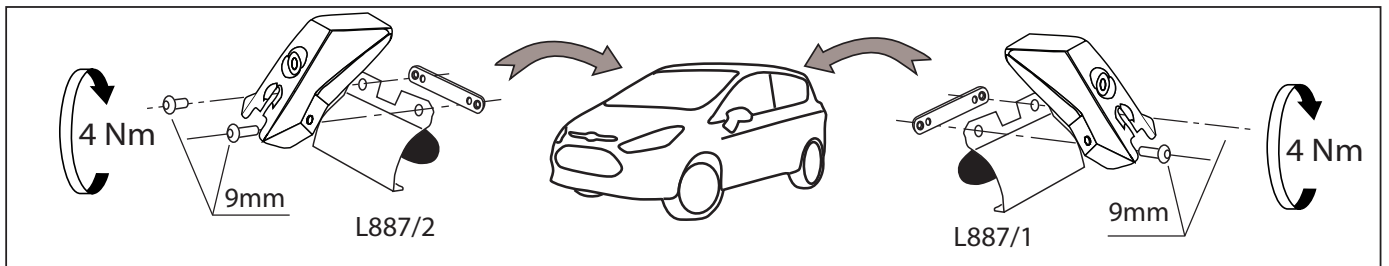
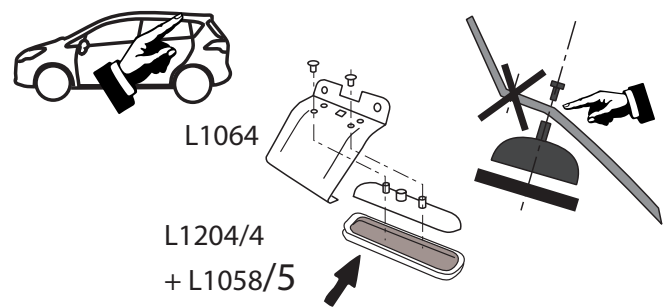
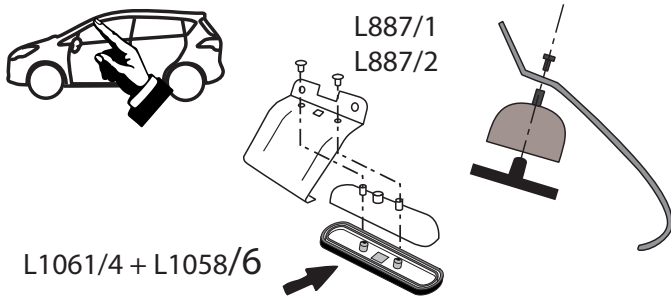

MOCSRR0AC011 cm 124

MOCSRR0AL007 cm 124

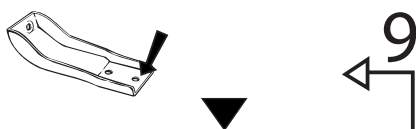

anteriore, avant, front,
vorne, delantera

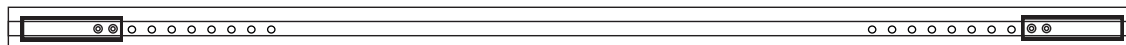
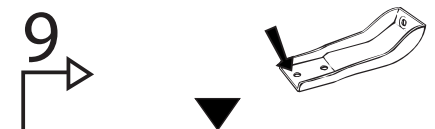

12 11 10 9 8 7 6 5 4 3 2 1

1 2 3 4 5 6 7 8 9 10 11 12

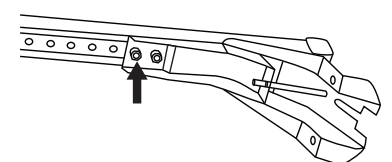
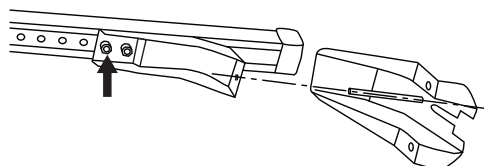
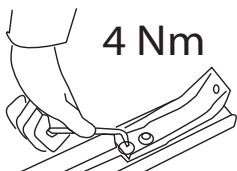

MOCSKT 235



MOCSRR0AC011 cm 124
MOCSRR0AL007 cm 124

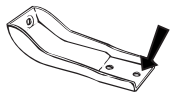

posteriore, arriere,
rear, hinten, trasera

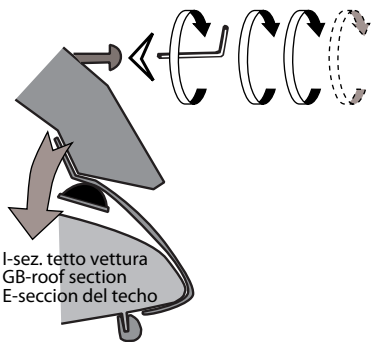
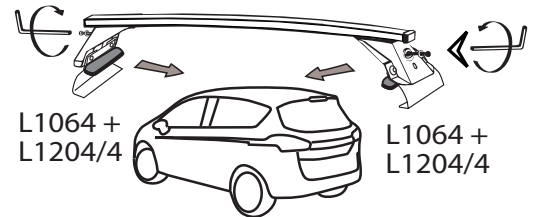
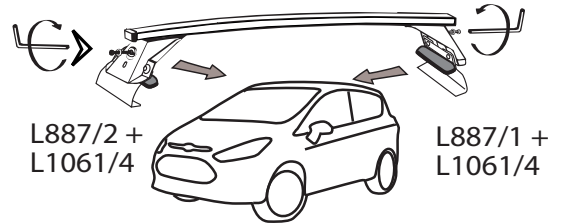
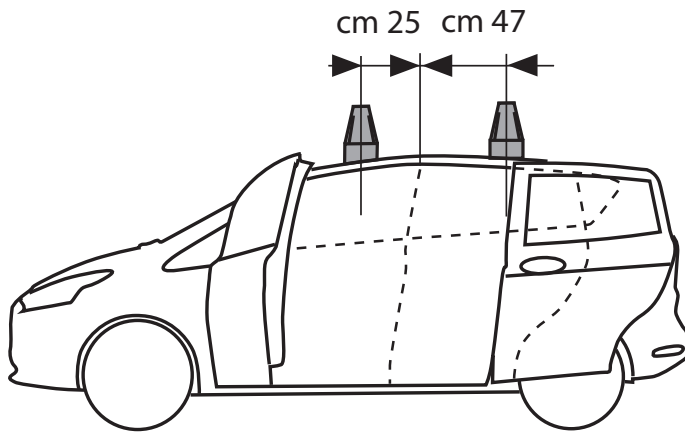
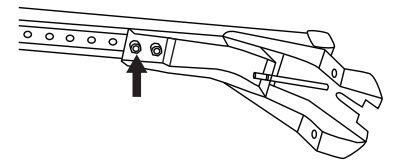
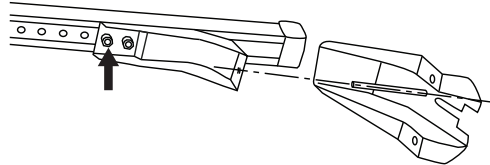
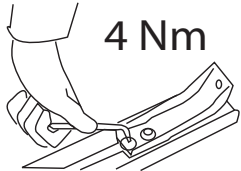
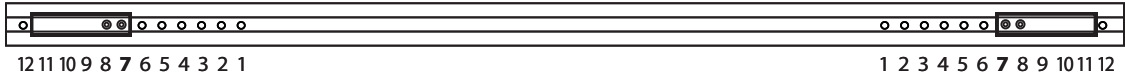
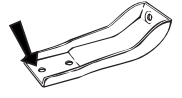

I-sez. tetto vettura
GB-roof section
E-seccion del techo

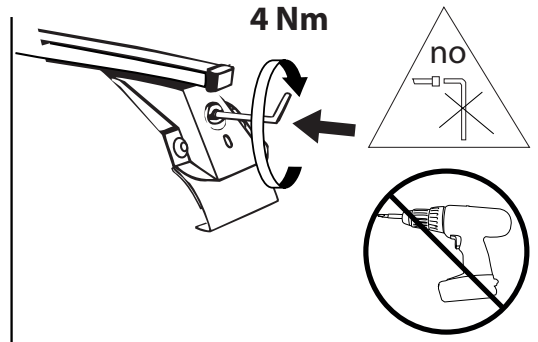
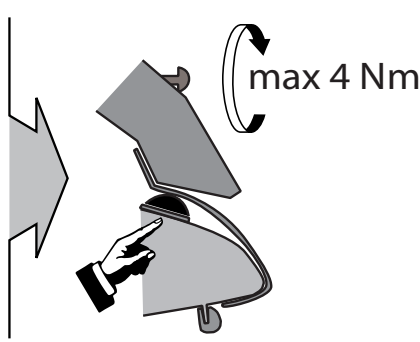

I - Per stringere, usare la chiave come indicato nel disegno. (Non si assumono responsabilità per danni causati dall'impiego di chiavi diverse da quella in dotazione al prodotto).

F - Pour serrer, utiliser la clé comme indique ci dessous.

GB - To tighten please use the wrench as per the drawing.

D - Zum Anziehen benutzen Sie bitte den Inbusschlüssel, nur wie auf dem Bild dargestellt.

E - Para el correcto ajuste, utilizar la llave fija tal y como se indica en la imagen

MODULA
case system

email: modulacs@modulacs.com
web site: www.modulacs.com

18-01-2016