









# HONDA Civic 5 porte/doors model 2012

## MOCSKT 223



**MOCSRR0AC011 cm 124**

**MOCSRR0AL007 cm 124**

1 - L1015/35 ant sx 	1 - L1151/35 post dx 	2 - RC1500/60 	8 - RCVM6X9Q 
1 - L1015/45 ant dx 	1 - L1151/45 post sx 	2 - RC1500/95 	4 - RC20200026 
			1 - RCBR5 

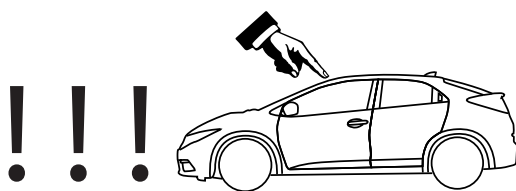
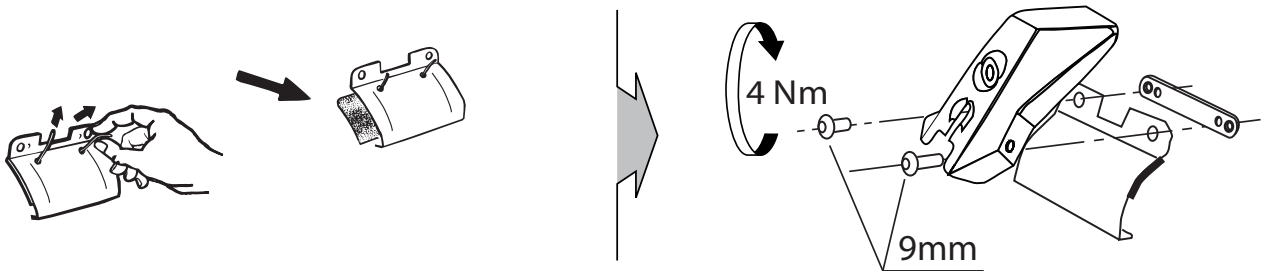
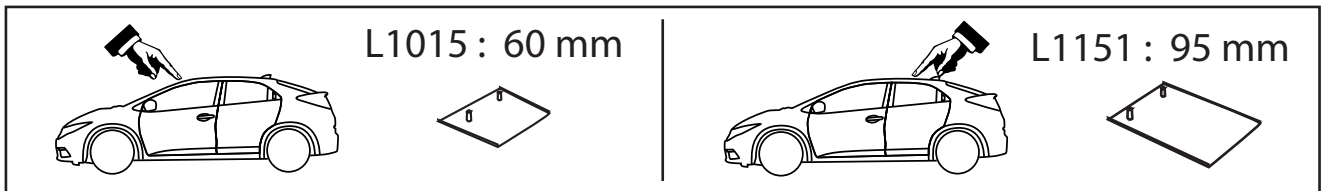

**MOCSRR0AC011 cm 124**

**MOCSRR0AL007 cm 124**

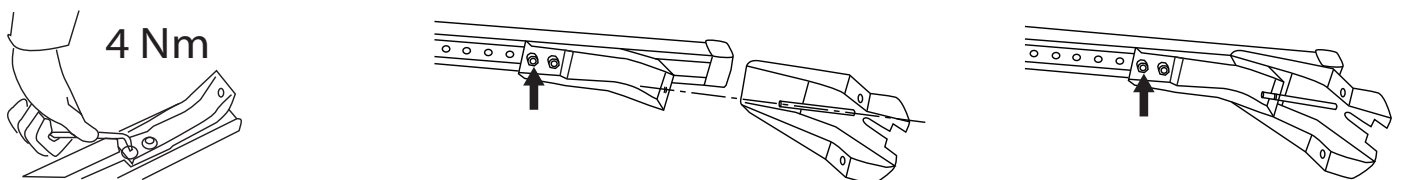
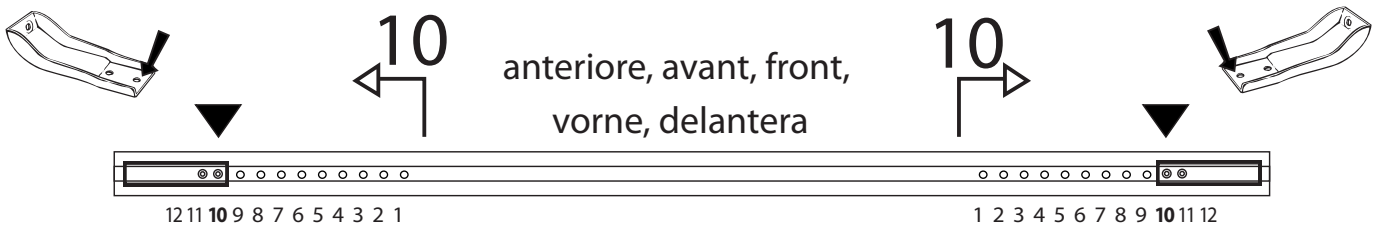

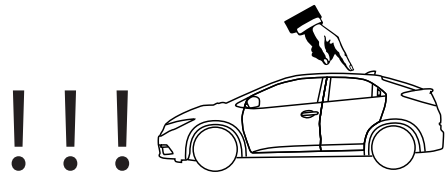

**MOCSRR0AC011 cm 124**  
**MOCSRR0AL007 cm 124**

**MOCSKT 223**

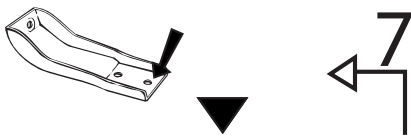

posteriore, arriere,  
rear, hinten, trasera

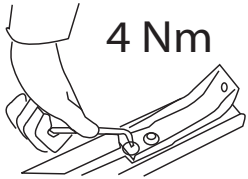
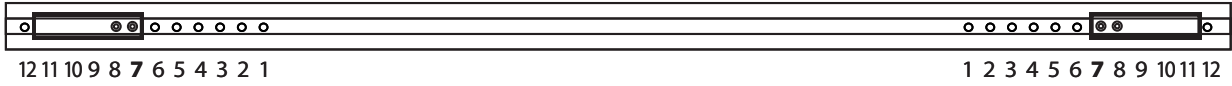
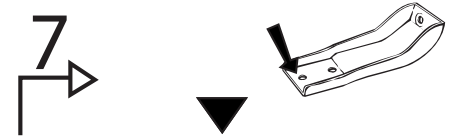

**4 Nm**

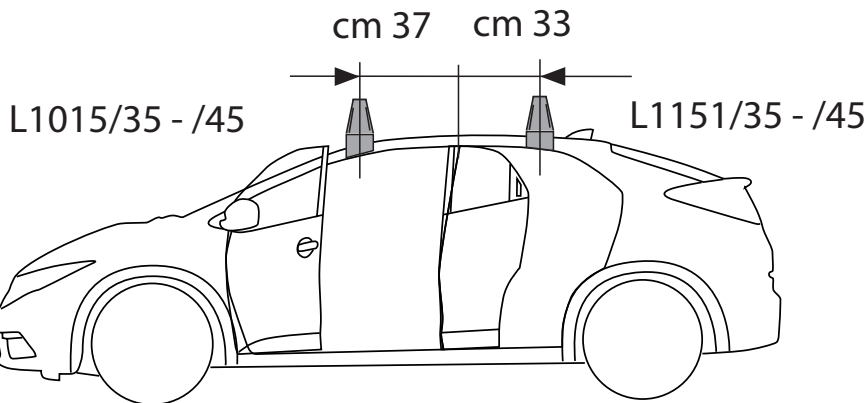
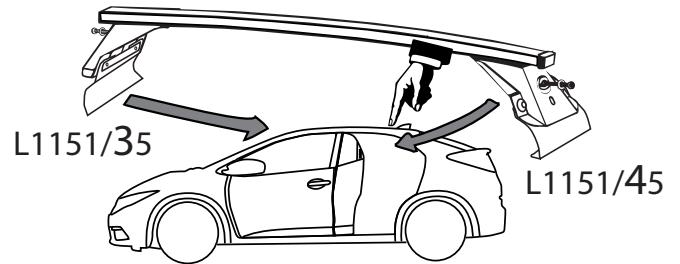
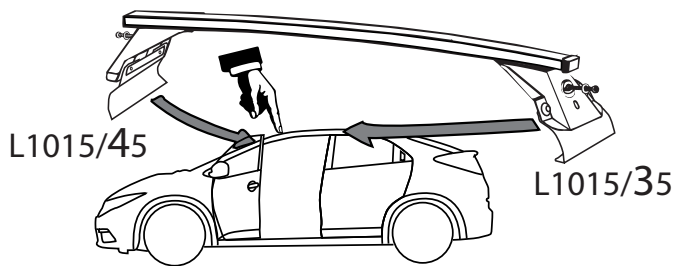
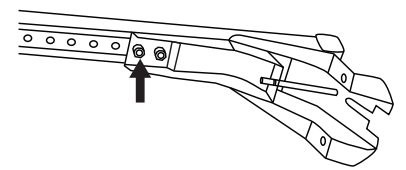
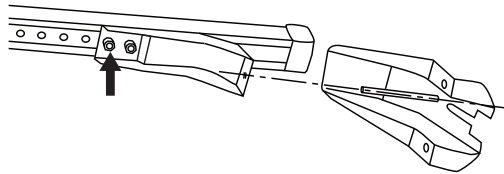

I - Per stringere, usare la chiave come indicato nel disegno. (Non si assumono responsabilità per danni causati dall'impiego di chiavi diverse da quella in dotazione al prodotto).  
 F - Pour serrer, utiliser la clé comme indique ci dessous.

GB - To tighten please use the wrench as per the drawing.  
 D - Zum Anziehen benutzen Sie bitte den Inbusschlüssel, nur wie auf dem Bild dargestellt.  
 E - Para el correcto ajuste, utilizar la llave fija tal y como se indica en la imagen

