

# CITROËN C4 model 2010

Patent pending  
**MOCSKT 213**

**MOCSRR0AC011 cm 124**

**MOCSRR0AL007 cm 124**



<p>2 - L1314/2 ant.</p>	<p>4 - L1058/7</p>	<p>8 - RCVM6X9Q</p>
<p>2 - L1314/3 post.</p>	<p>4 - RCVM6X14TSQ</p> <p>14 mm</p>	<p>1 - RCBR5</p>
	<p>4 - RCRD8Q</p>	<p>1 - RCBR4</p>

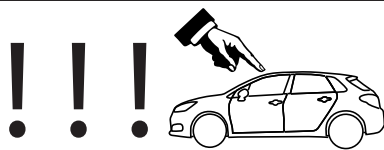
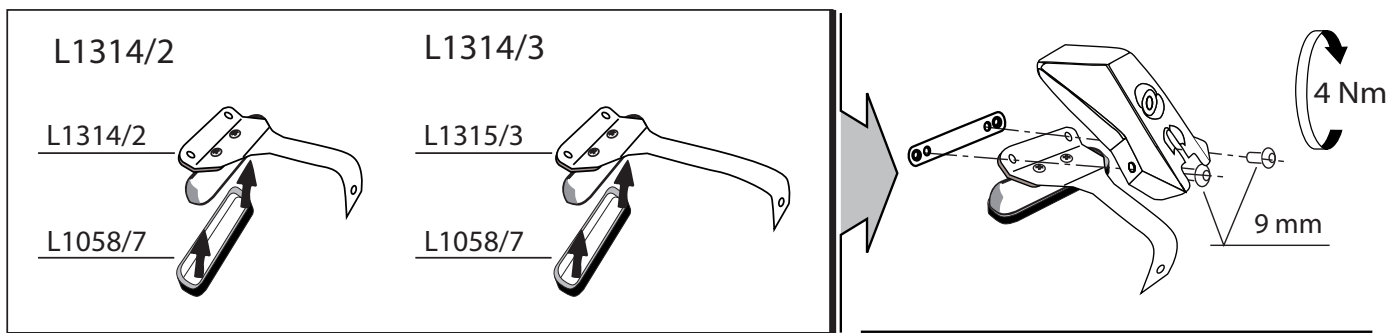

**MOCSRR0AC011 cm 124**  
**MOCSRR0AL007 cm 124**

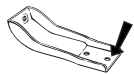

anteriore, avant, front,  
vorne, delantera

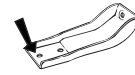

12 11 10 9 8 7 6 5 4 3 2 1

1 2 3 4 5 6 7 8 9 10 11 12

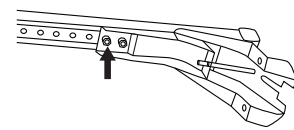
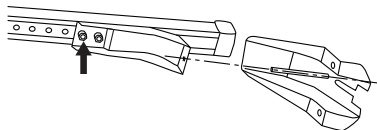
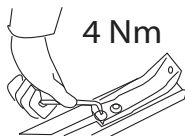

**MOCSRR0AC011 cm 124**  
**MOCSRR0AL007 cm 124**

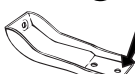

posteriore, arriere,  
rear, hinten, trasera



12 11 10 9 8 7 6 5 4 3 2 1

1 2 3 4 5 6 7 8 9 10 11 12

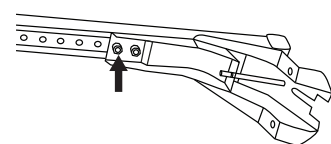
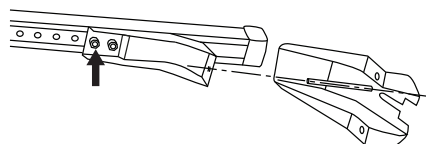
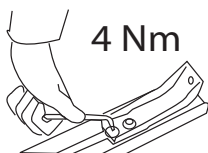

# MOCSKT 213

