

KIA Picanto II 5 porte/doors model 2011

MOCSKT 207

KIA Picanto II 3 porte/doors model 2012



MOCSRR0AC010 cm 110

MOCSRR0AL006 cm 110

| | | | |
|-------------------|--------------------|----------------|----------------|
| 1 - L935/3 ant sx | 1 - L953/3 post dx | 4 - RC1500/60 | 4 - RC20200026 |
| 1 - L935/4 ant dx | 1 - L953/4 post sx | 8 - RCVM6X9Q | 1 - RCBR5 |
| | | 1 - inseritore | |

I-montare le guarnizioni
GB-fit the gaskets
E- montar las juntas

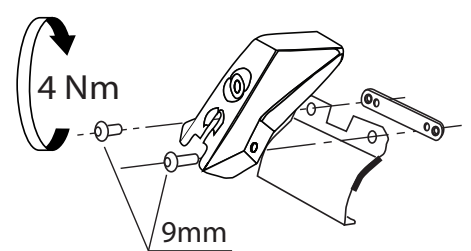
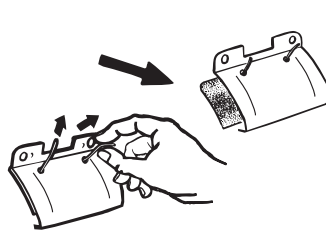
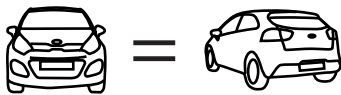

MOCSRR0AC010 cm 110
MOCSRR0AL006 cm 110

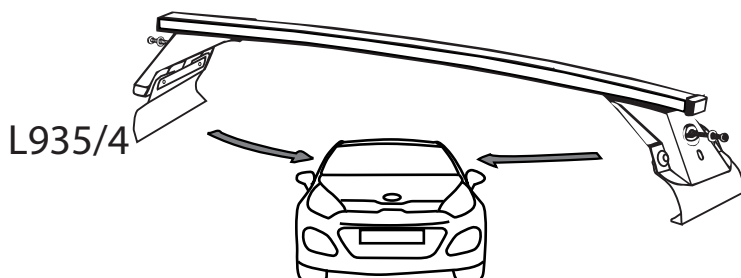
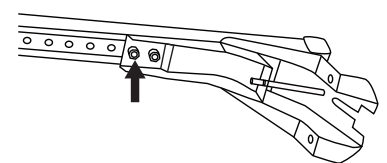
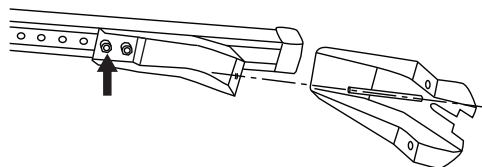
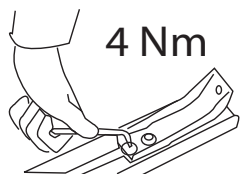
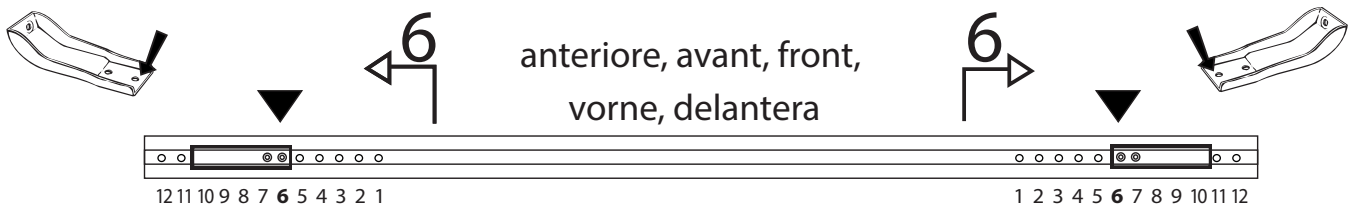

L935/3



I-sez. tetto vettura
GB-roof section
E-seccion del techo

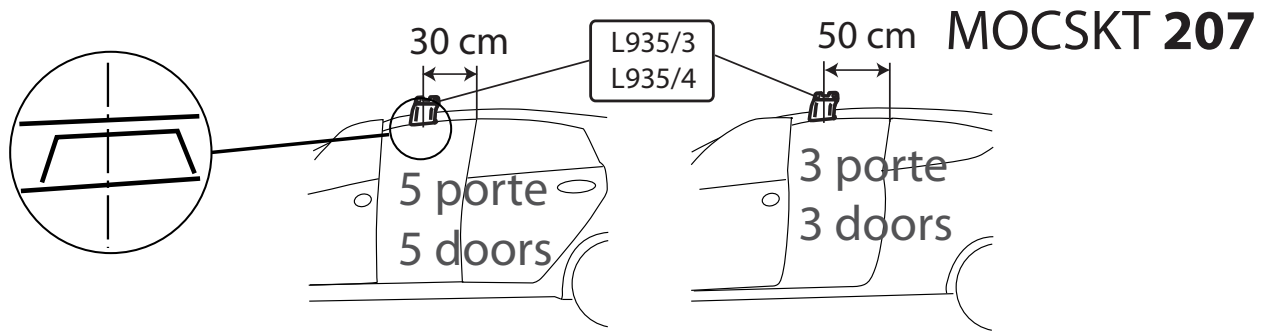

MOC SRR0AC010 cm 110
MOC SRR0AL006 cm 110

posteriore, arriere,
 rear, hinten, trasera

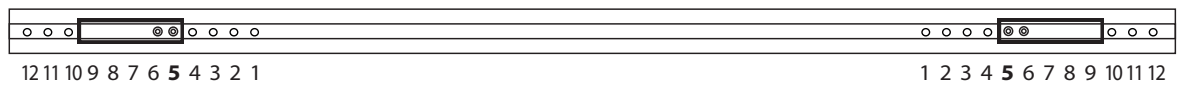
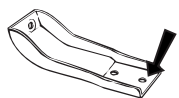
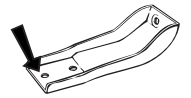

4 Nm

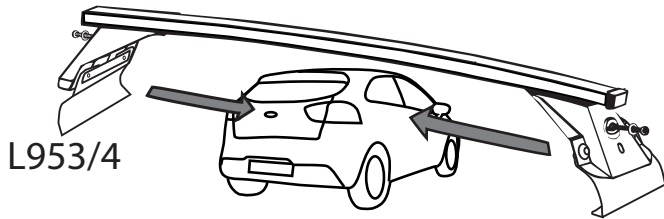
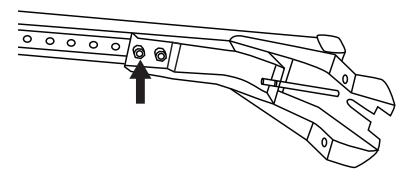
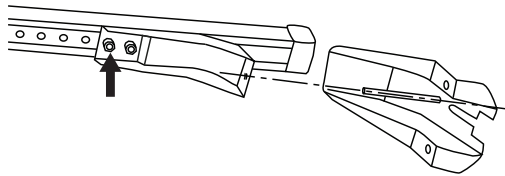
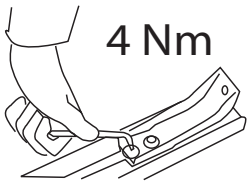

L953/3

I-sez. tetto vettura
 GB-roof section
 E-seccion del techo

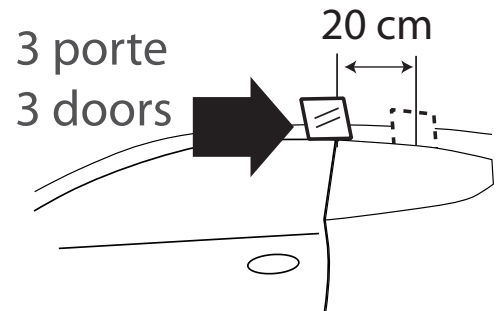
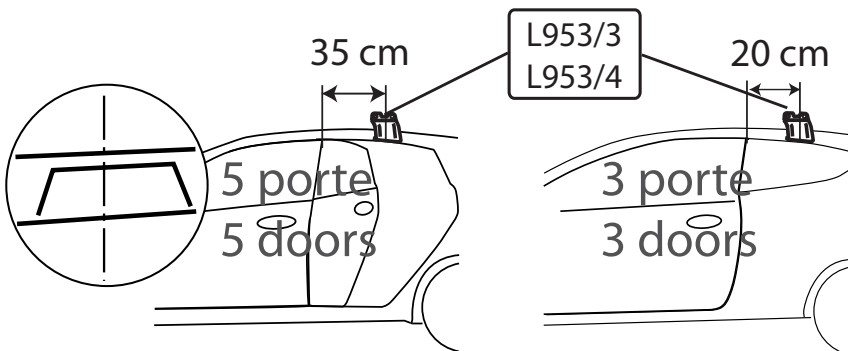

I - Per stringere, usare la chiave come indicato nel disegno. (Non si assumono responsabilità per danni causati dall'impiego di chiavi diverse da quella in dotazione al prodotto).
 F - Pour serrer, utiliser la clé comme indique ci dessous.

GB - To tighten please use the wrench as per the drawing.
 D - Zum Anziehen benutzen Sie bitte den Inbusschlüssel, nur wie auf dem Bild dargestellt.
 E - Para el correcto ajuste, utilizar la llave fija tal y como se indica en la imagen

