

FORD Focus 5 porte/doors

model 2011

MOCSKT 190



MOCSRR0AC011 cm 124

MOCSRR0AL007 cm 124

1 - L1289/1 ant. sx		1 - L1289/3 post. dx		2 - RC1500/95		8 - RCVM6X9Q	
1 - L1289/2 ant. dx		1 - L1289/4 post. sx		2 - L1315/4		4 - RC20200026	
				2 - L1058/6		1 - RCBR5	

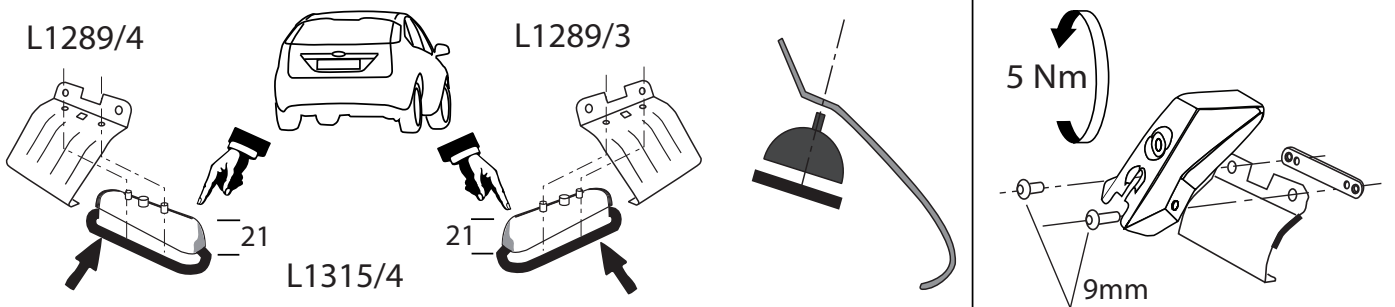
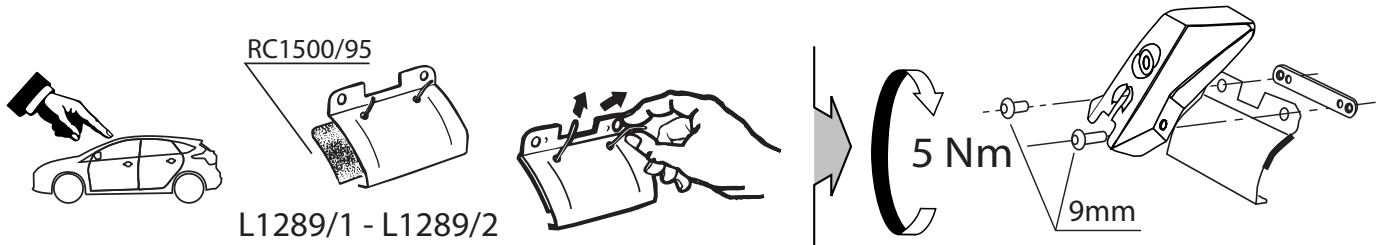

MOCSRR0AC011 cm 124
MOCSRR0AL007 cm 124

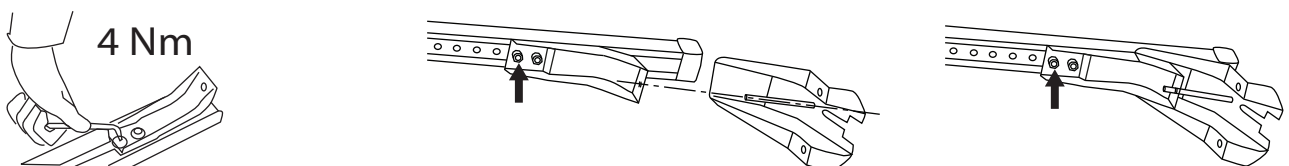
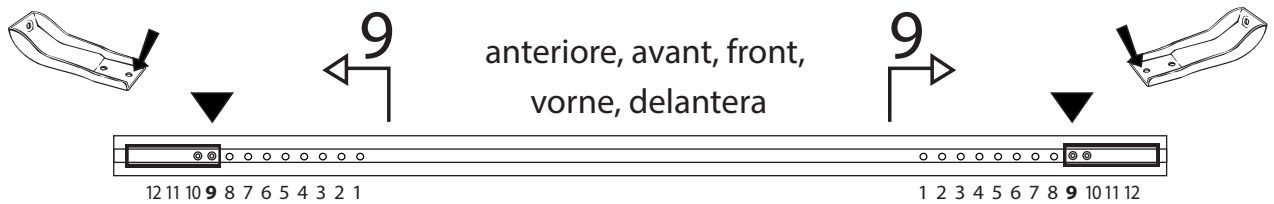

MOCSKT 190

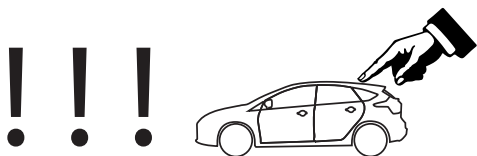

MOCSRROAC011 cm 124

MOCSRROAL007 cm 124

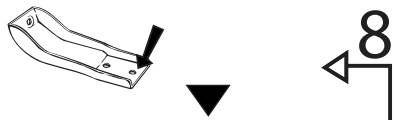

posteriore, arriere,
rear, hinten, trasera

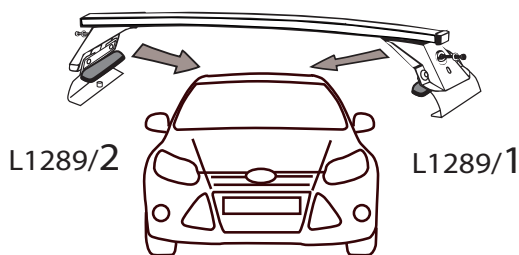
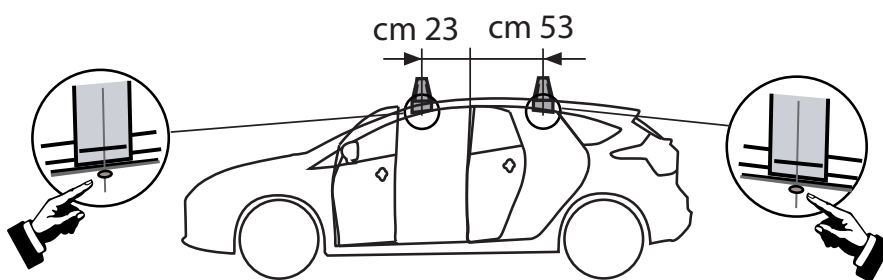
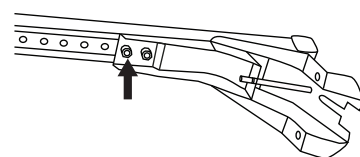
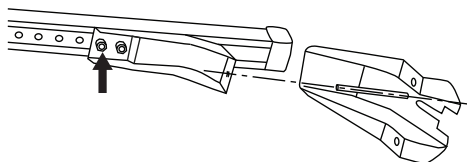
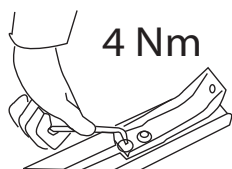
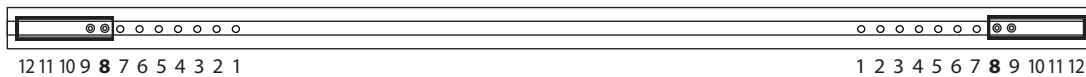
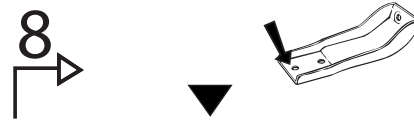

Modula s.r.l.
Loc. Penisola, 20/A
61026 Piandimeleto (PU) ITALY
phone +39 0722/700070
fax +39 0722/720017

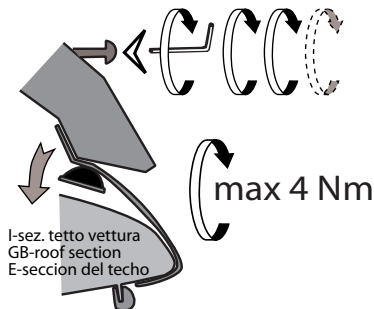
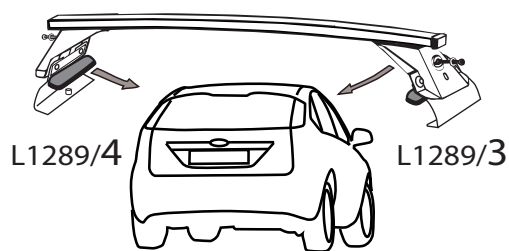
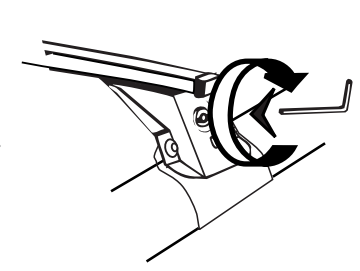
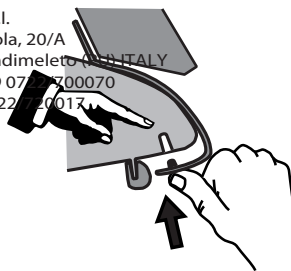

I - Per stringere, usare la chiave come indicato nel disegno. (Non si assumono responsabilità per danni causati dall'impiego di chiavi diverse da quella in dotazione al prodotto).
F - Pour serrer, utiliser la clé comme indique ci dessous.

GB - To tighten please use the wrench as per the drawing.
D - Zum Anziehen benutzen Sie bitte den Inbusschlüssel, nur wie auf dem Bild dargestellt.
E - Para el correcto ajuste, utilizar la llave fija tal y como se indica en la imagen

