



MOCSRROAC010 cm 110

MOCSRROAL006 cm 110

componenti:

1 - L1268/1 ant sx



1 - L1268/3 post dx



2 - RC1500/95 post.



4 - RC20200026

1 - L1268/2 ant dx



1 - L1268/4 post sx



4 - RCVM6X12Q 12 mm



1 - RCBR5



2 - RC1500/60 ant



8 - RCVM6X9Q 9 mm

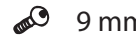

1 - RCRB4



I-montare le guarnizioni
F - monter les joints
GB - fit the gaskets
D - Die Dichtungen einsetzen
E - montar las juntas

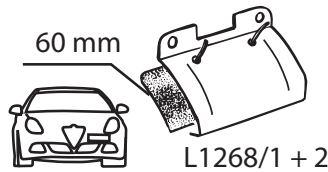

L1268/1 + 2

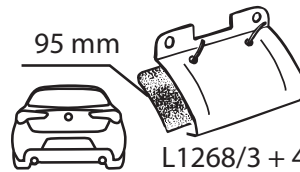

L1268/3 + 4

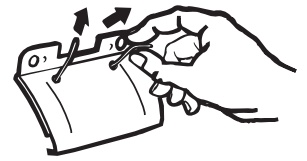

I - montare gli attacchi anteriori
F - monter les griffer avant
GB - fit the front clamps
D - Die vorne Klammern einsetzen
E - ajustar las pletinas delantera

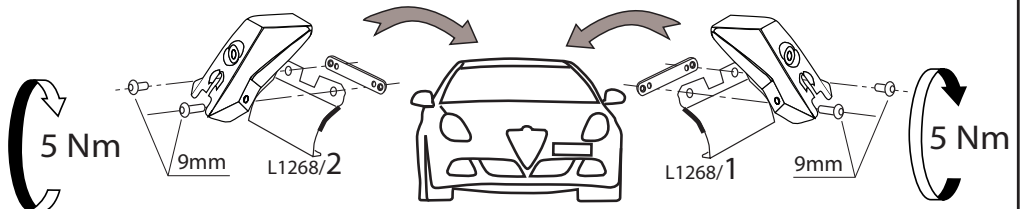

MOCSRROAC010 cm 110

MOCSRROAL006 cm 110

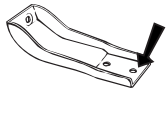

6 anteriore, avant, front, vorne, delantera

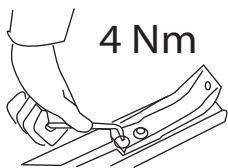
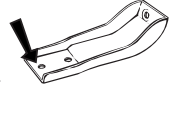

4 Nm

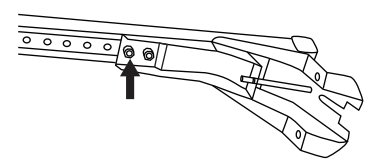
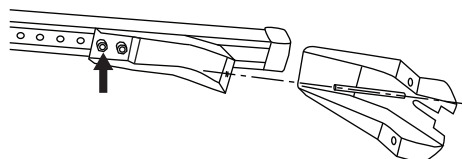

I-montare la barra anteriore.
GB- fit the front bar.
E- ajustar la barra frontal.

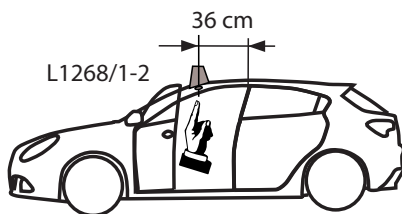

L1268/1-2

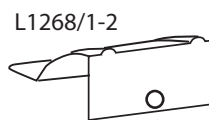

L1268/1-2

I-sez. tetto vettura
GB-roof section
E- seccion del techo



RCVM6X12Q

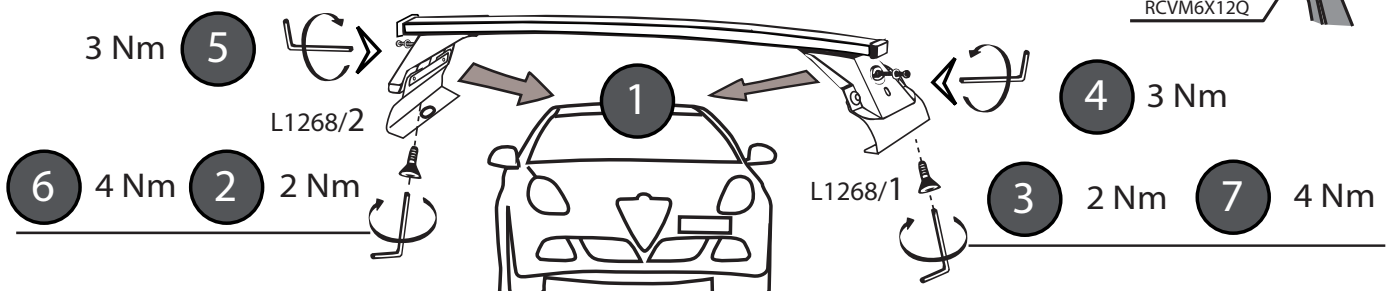

MOCSKT 170

- I - montare gli attacchi posteriori
- F - monter les griffer arrière
- GB - fit the rear clamps
- D - Die hinten Klammern einsetzen
- E - ajustar las pletinas traseras

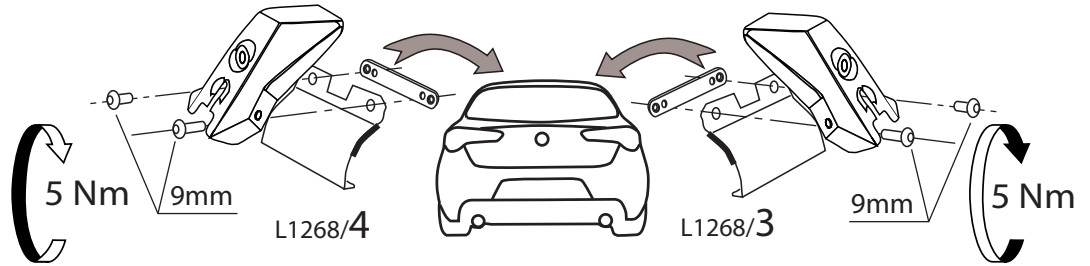

!!! MOCSRR0AC010 cm 110 MOCSRR0AL006 cm 110

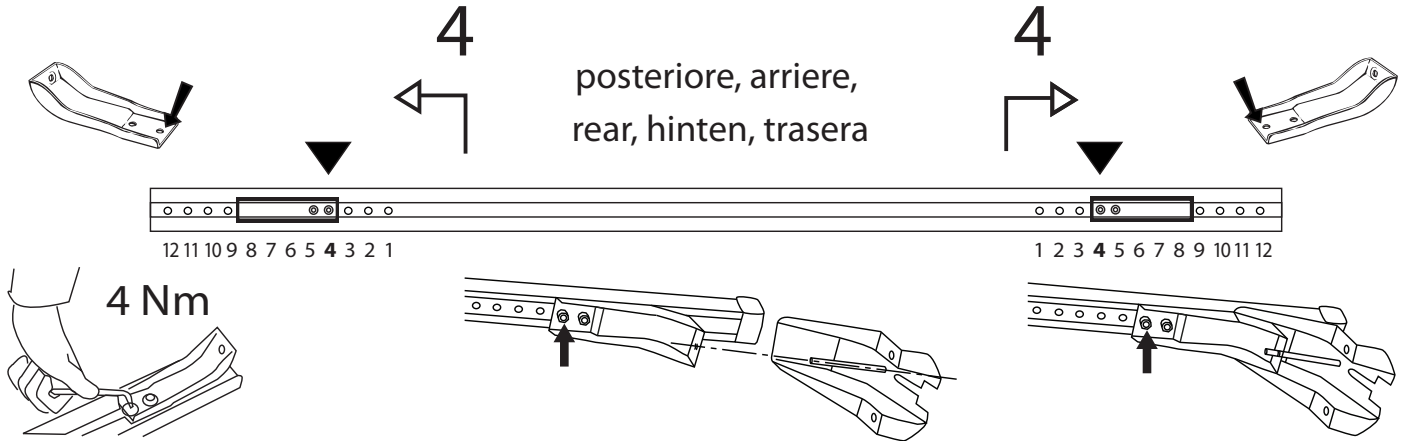

- I - montare la barra posteriore
- GB - fit the rear bar
- E - ajustar la barra trasera

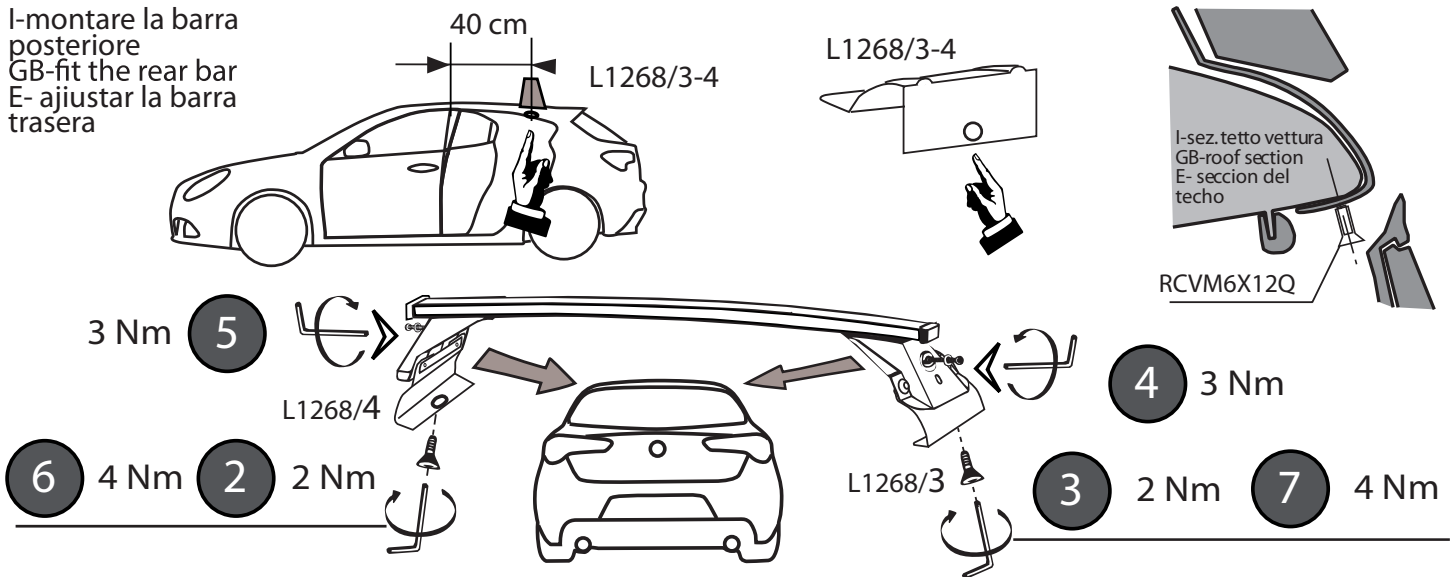

- I - Per stringere, usare la chiave come indicato nel disegno. (Non si assumono responsabilità per danni causati dall'impiego di chiavi diverse da quella in dotazione al prodotto).
- F - Pour serrer, utiliser la clé comme indique ci dessous.

- GB - To tighten please use the wrench as per the drawing.
- D - Zum Anziehen benutzen Sie bitte den Inbusschlüssel, nur wie auf dem Bild dargestellt.
- E - Para el correcto ajuste, utilizar la llave fija tal y como se indica en la imagen

