

TOYOTA RAV4 model 2006
no railing - senza barre



MOC SKT 157

MOC SRR0AC011 cm 124
MOC SRR0AL007 cm 124

componenti:					
2 - L816/3 ant.		4 - L1204/4		8 - RCVM6X9Q	
2 - L1036 post.		4 - L1058/5		4 - RC20200026	
				1 - RCBR5	

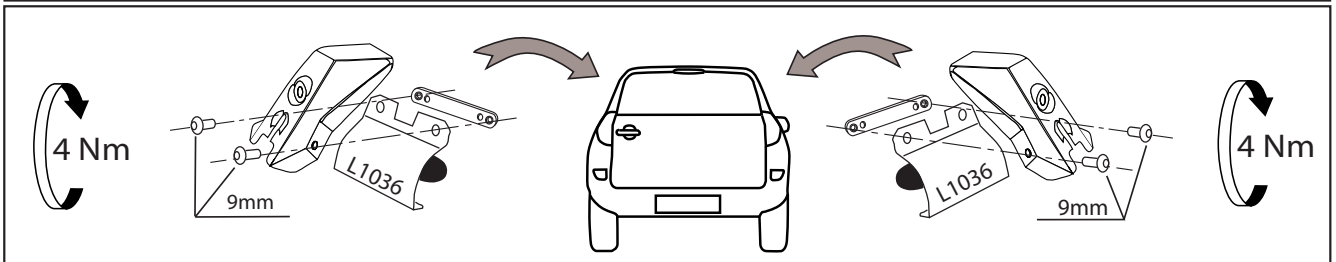
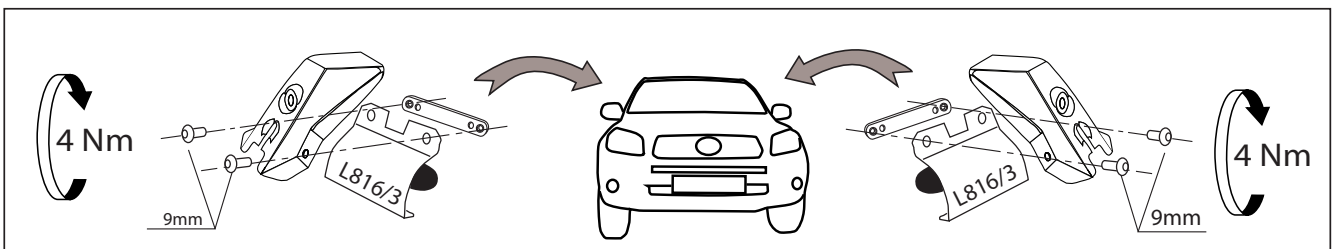
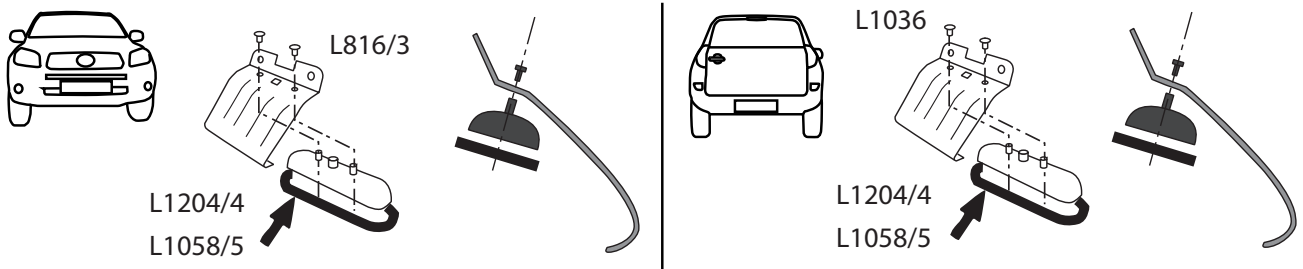

!!! **MOC SRR0AC011 cm 124**
MOC SRR0AL007 cm 124

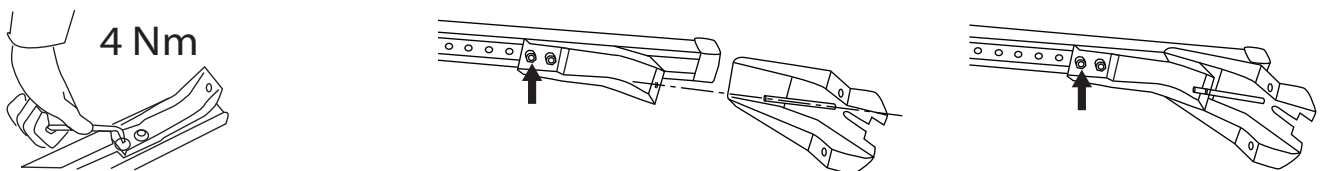
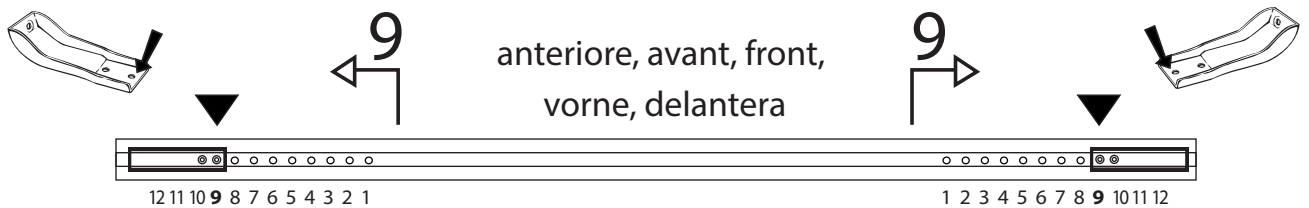

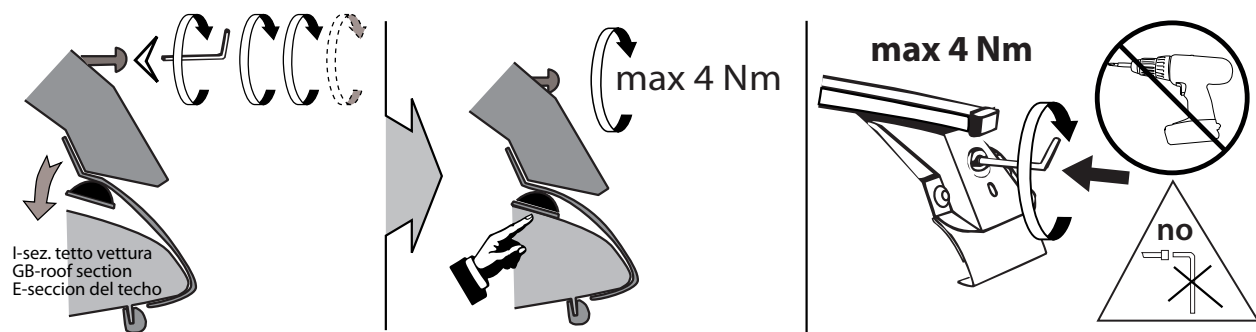
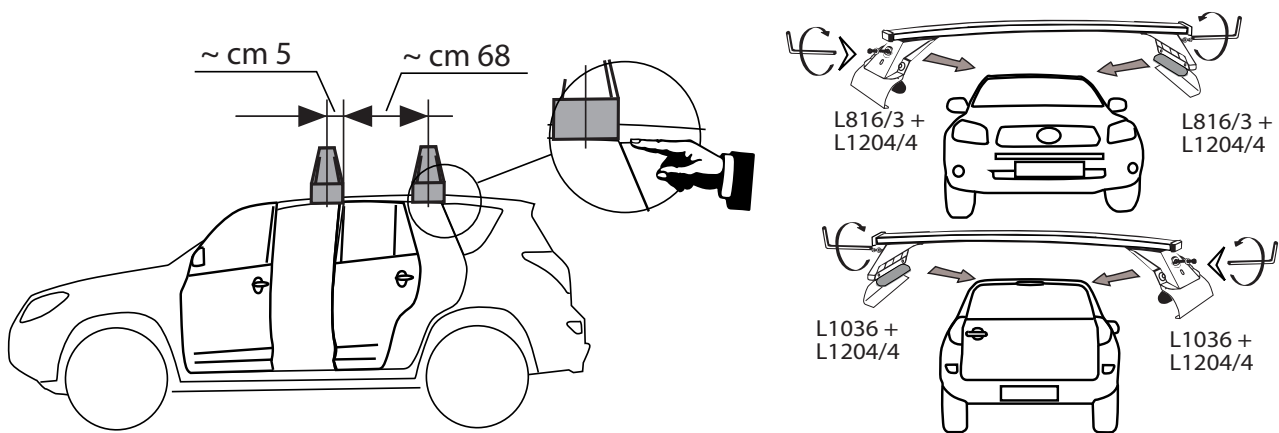

I - Per stringere, usare la chiave come indicato nel disegno. (Non si assumono responsabilità per danni causati dall' impiego di chiavi diverse da quella in dotazione al prodotto).

F - Pour serrer, utiliser la clé comme indique ci dessous.

GB - To tighten please use the wrench as per the drawing.

D - Zum Anziehen benutzen Sie bitte den Inbusschlüssel, nur wie auf dem Bild dargestellt.

E - Para el correcto ajuste, utilizar la llave fija tal y como se indica en la imagen

I Si raccomanda, dopo il montaggio e periodicamente di verificare il fissaggio. La ditta non si assume responsabilità per eventuali danni riportati da persone o cose dovuti al cattivo impiego dei suoi prodotti.

F On recommande, après le montage et périodiquement de vérifier le fixage. La maison décline toutes responsabilités pour éventuels dommages dus au mauvais emploi de ses produits.

GB We recommend after assembly and periodically to verify the fixing. The firm dont take responsibility for eventual damages or injury due to the bad use of his products.

D Es empfiehlt sich, dass ab und zu die richtige Befestigung überwacht werden. Unsere Firma haftet nicht für möglichen Schade zu Person und Sachen wegen der unfähigen Anwendung unserer Erzeugnisse.

E Se recomienda verificar la sujeción periódicamente y después de cada montaje. La empresa no se hace responsable de los daños que se puedan ocasionar como consecuencia del mal uso de nuestros productos.

