







TOYOTA Verso model 2009

MOSRR0AC011 cm 124

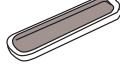
MOSRR0AL007 cm 124



componenti: 2 - L1036 ant.  2 - L1230/3 post. 	4 - L1204/4  4 - L1058/5 	8 - RCVM6X9Q  4 - RC20200026 	1 - RCB5 
--	--	--	--

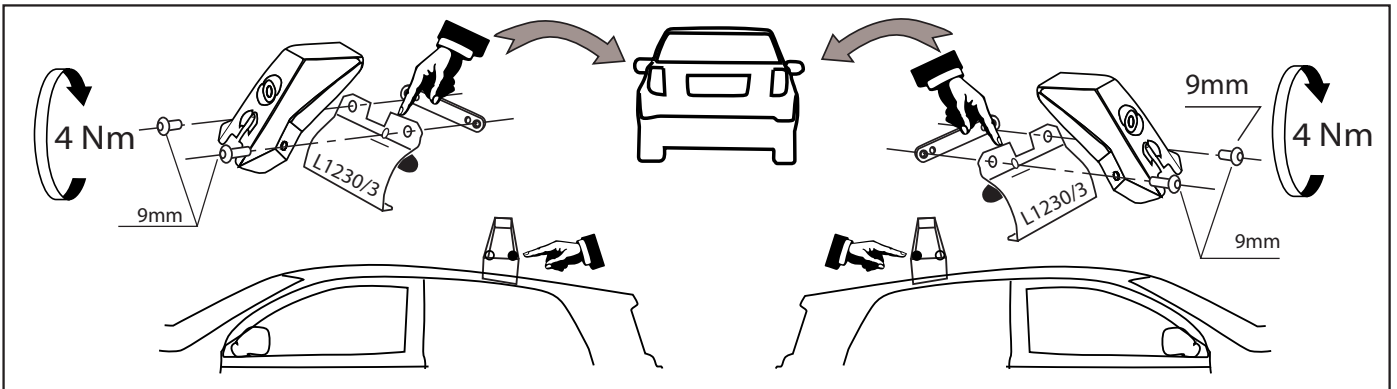
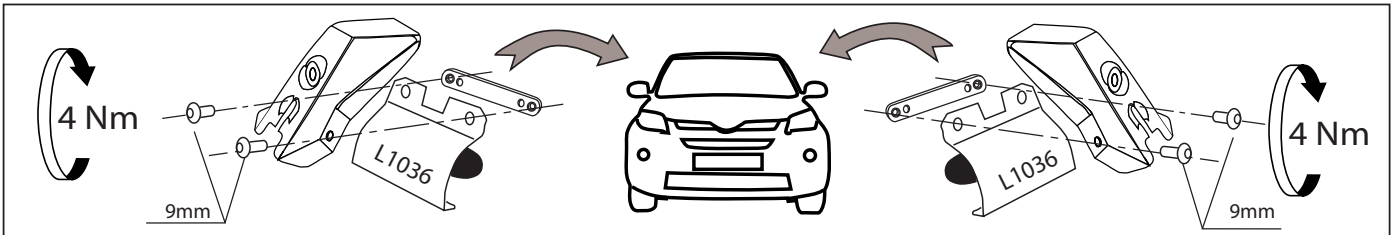
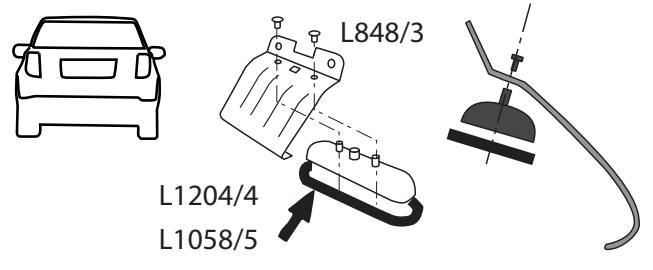
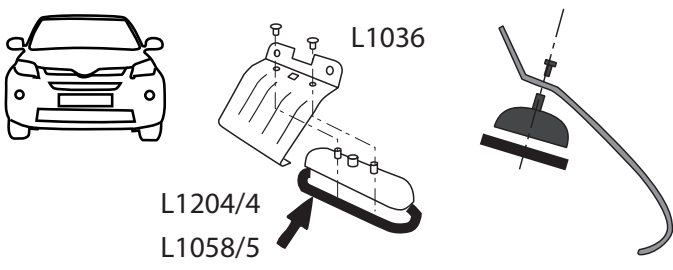

MOSRR0AC011 cm 124

MOSRR0AL007 cm 124

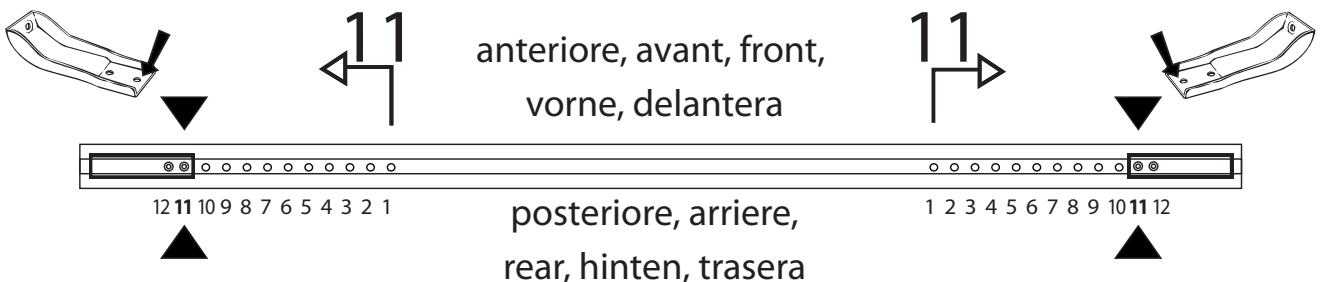

MOCSKT 137

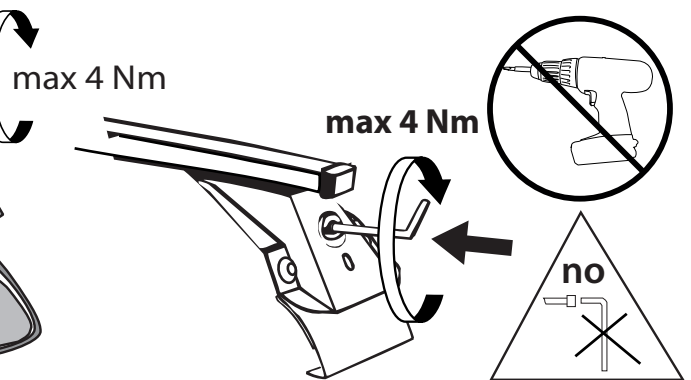
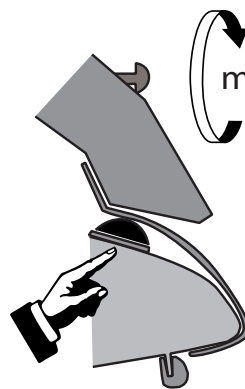
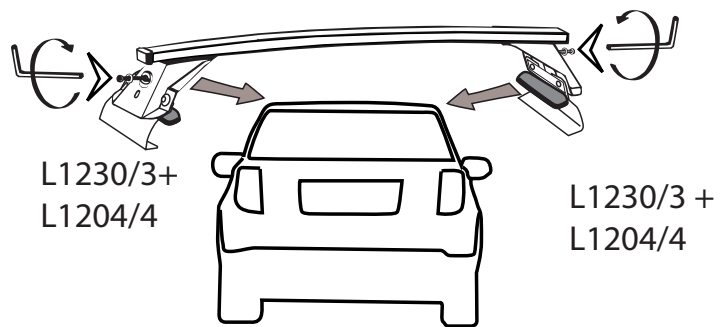
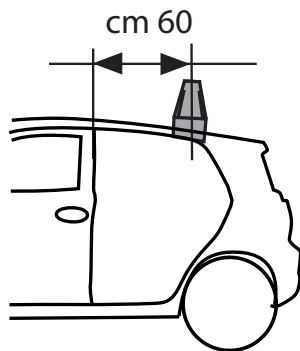
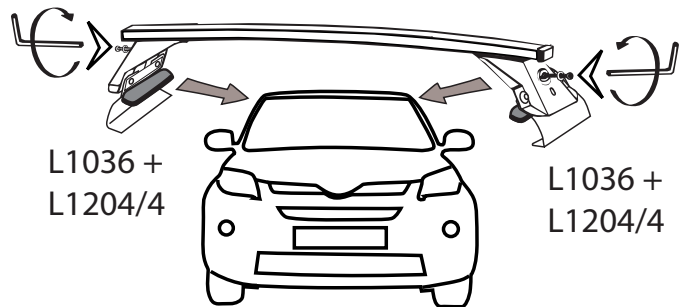
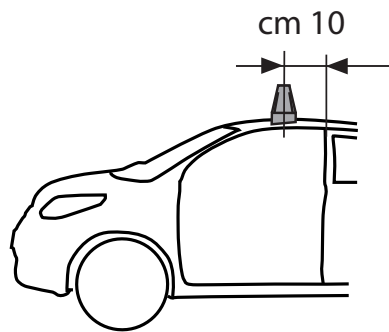
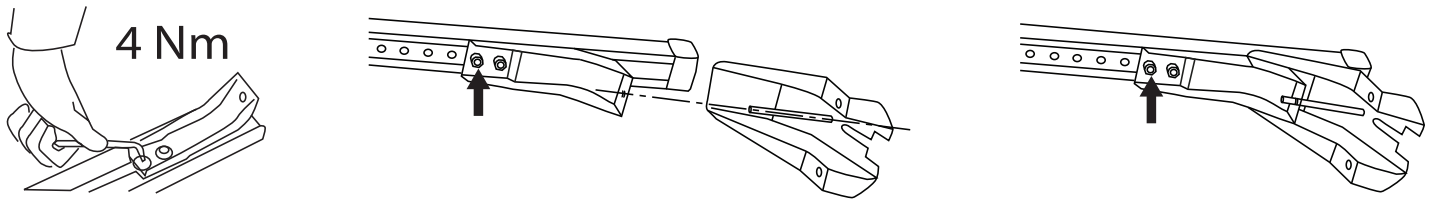

I - Per stringere, usare la chiave come indicato nel disegno. (Non si assumono responsabilità per danni causati dall'impiego di chiavi diverse da quella in dotazione al prodotto).

F - Pour serrer, utiliser la clé comme indique ci dessous.

GB - To tighten please use the wrench as per the drawing.

D - Zum Anziehen benutzen Sie bitte den Inbusschlüssel, nur wie auf dem Bild dargestellt.

E - Para el correcto ajuste, utilizar la llave fija tal y como se indica en la imagen