

BMW X6 2008

MOCSKT 118

MOCSRROAC011 cm 124
MOCSRROAL007 cm 124



2 - L1209/1		4 - L1061/4		8 - RCVM6X9Q	
2 - L1209/2		4 - L1058/7		1 - RCBR5	
		4 - RC20200026			

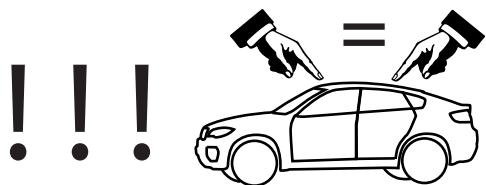
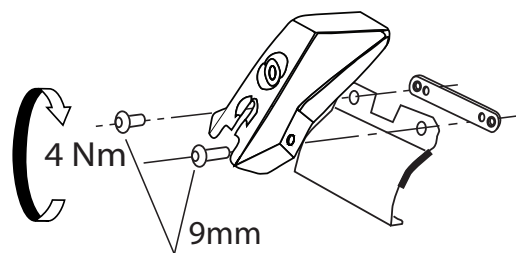
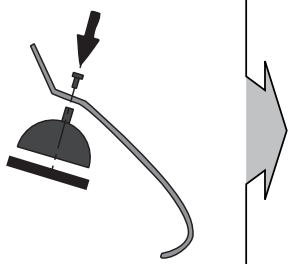
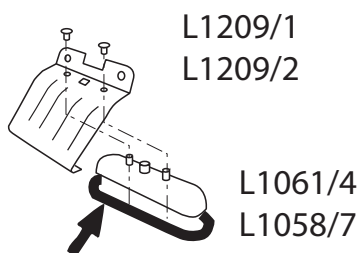

MOCSRROAC011 cm 124
MOCSRROAL007 cm 124

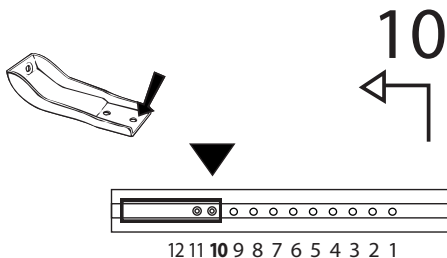

anteriore, avant, front,
vorne, delantera

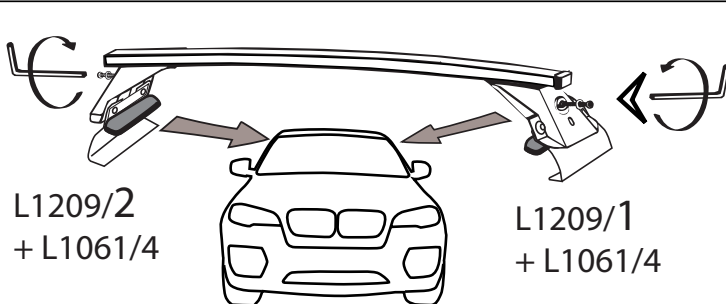
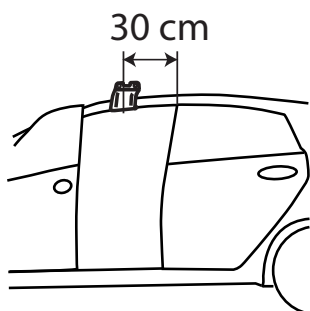
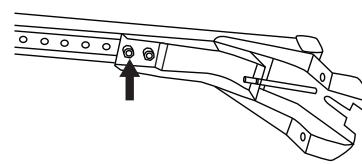
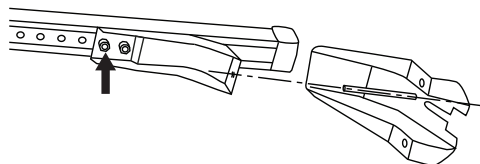
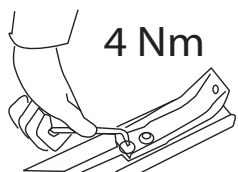
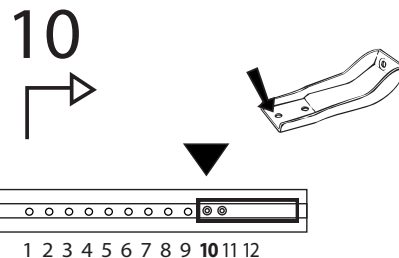

MOCSKT 118

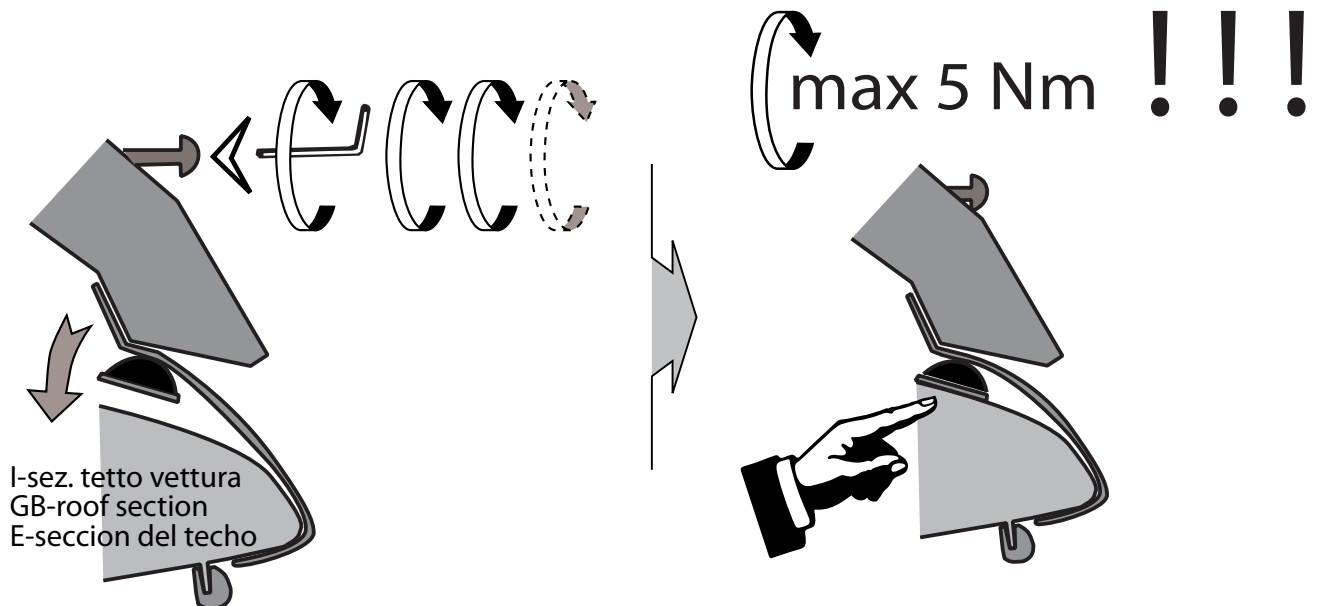
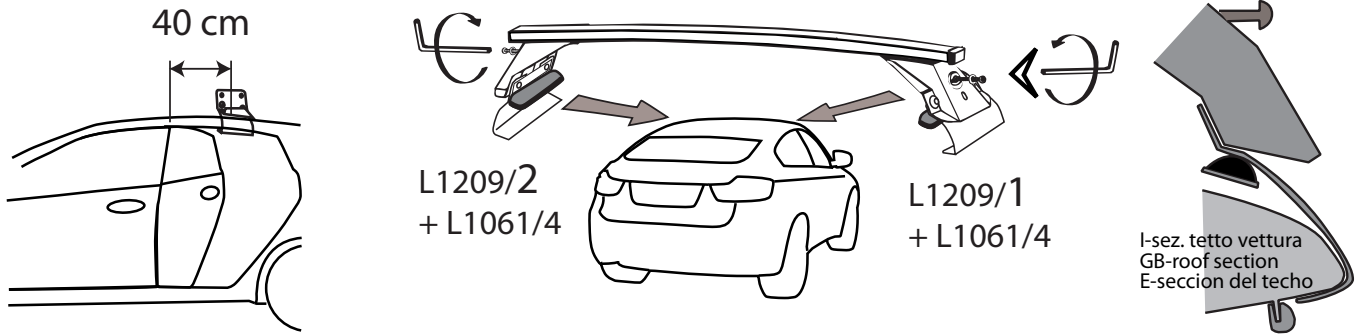

I - Per stringere, usare la chiave come indicato nel disegno. (Non si assumono responsabilità per danni causati dall'impiego di chiavi diverse da quella in dotazione al prodotto).

F - Pour serrer, utiliser la clé comme indique ci dessous.

GB - For tightening, please use the wrench as per the drawing.

D - Zum Anziehen benutzen Sie bitte den Inbusschlüssel, nur wie auf dem Bild dargestellt.

E - Para el correcto ajuste, utilizar la llave fija tal y como se indica en la imagen

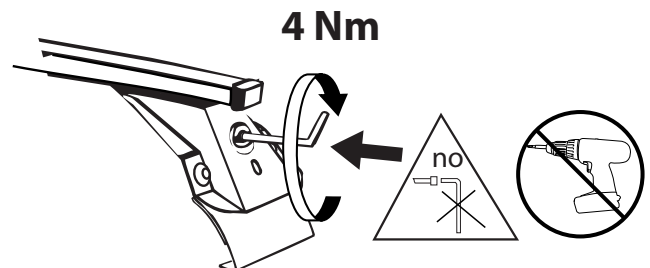

MODULA
case system

email: modulacs@modulacs.com
web site: www.modulacs.com

Modula s.r.l.
Loc. Penisola, 20/A
61026 Piandimeleto (PU) ITALY
phone +39 0722/700070
fax +39 0722/720017

18-01-2016