







# Citroën C5 berlina model 2008

MOCSKT 107

MOCSRR0AC010 cm 110

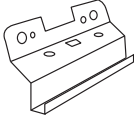
MOCSRR0AL006 cm 110

MOCSRR0AL008 cm 110

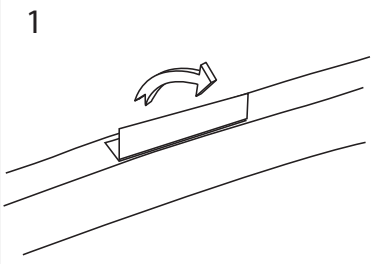
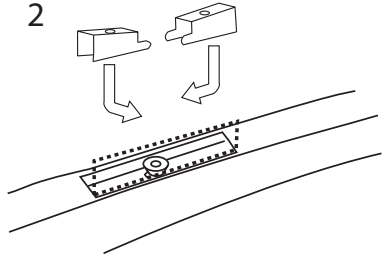
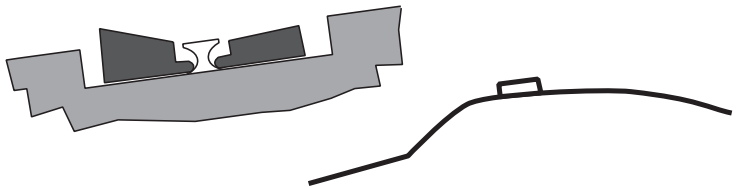
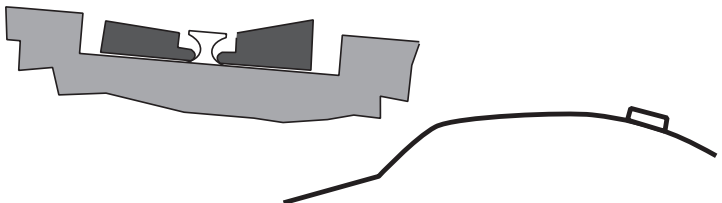
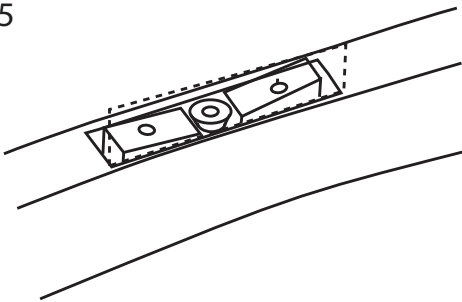
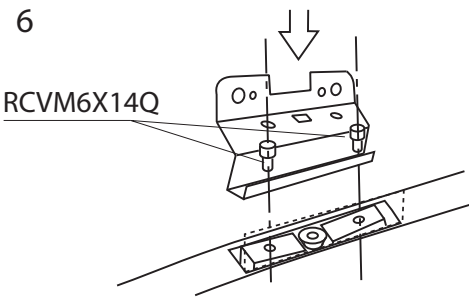
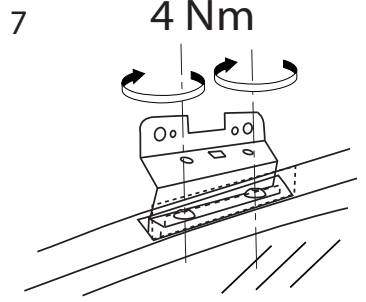
<p>componenti</p> <p>4 - L1084/4 </p> <p>4 - L1173/5 </p> <p>4 - L1084 </p> <p>8 - RCVM6X9Q </p> <p>8 - RCVM6X14Q </p> <p>4 - RC20200026 </p> <p>1 - RCBR5 normale </p>	<p>1 </p>	<p>2 </p>
<p>3 anteriore, avant, front, vorne, delantera</p> 		
<p>4 posteriore, arriere, rear, hinten, trasera</p> 		
<p>5 </p>	<p>6 </p> <p>RCVM6X14Q</p>	<p>7 </p> <p>4 Nm</p>

# MOCSKT 107

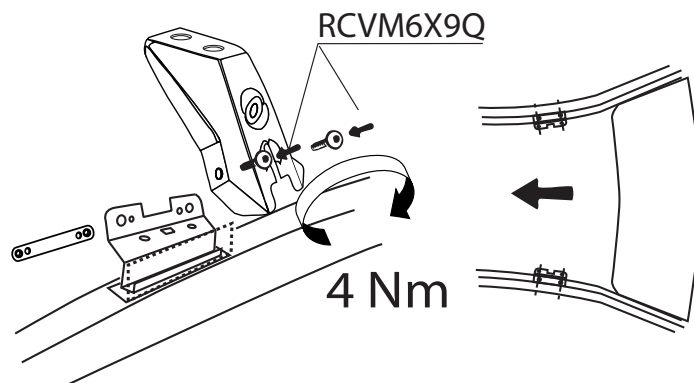
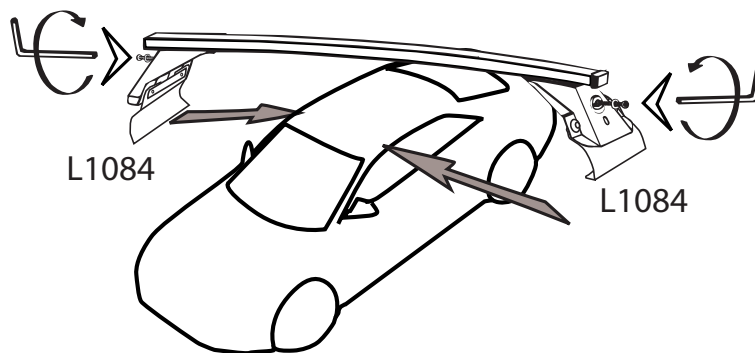
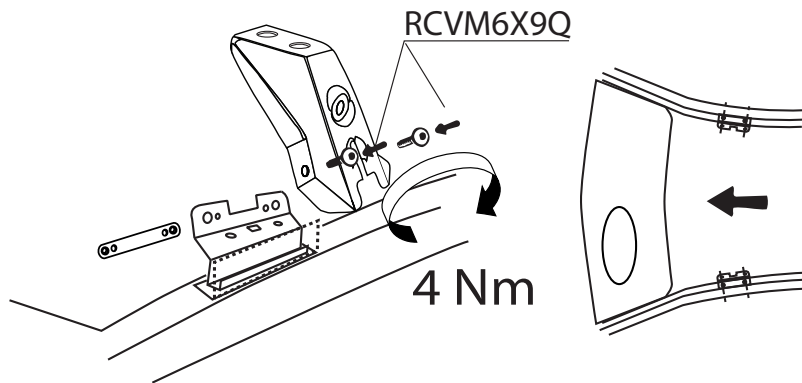

**I** Si raccomanda, dopo il montaggio e periodicamente di verificare il fissaggio. La ditta non si assume responsabilità per eventuali danni riportati da persone o cose dovuti al cattivo impiego dei suoi prodotti.

**F** On recommande, après le montage et périodiquement de vérifier le fixage. La maison décline toutes responsabilités pour éventuels dommages dus au mauvais emploi de ses produits.

**GB** We recommend after assembly and periodically to verify the fixing. The firm don't take responsibility for eventual damages or injury due to the bad use of his products.

**D** Es empfiehlt sich, dass ab und zu die richtige Befestigung überwacht werden. Unsere Firma haftet nicht für möglichen Schade zu Person und Sachen wegen der unfähigen Anwendung unserer Erzeugnisse.

**E** Se recomienda verificar la sujeción periódicamente y después de cada montaje. La empresa no se hace responsable de los daños que se puedan ocasionar como consecuencia del mal uso de nuestros productos.

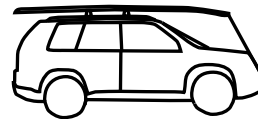

**MODULA**  
case system

email: [modulacs@modulacs.com](mailto:modulacs@modulacs.com)  
web site: [www.modulacs.com](http://www.modulacs.com)

Modula s.r.l.  
Loc. Penisola, 20/A  
61026 Piandimeleto (PU) ITALY  
phone +39 0722/700070  
fax +39 0722/720017

18-01-2016