

OPEL Agila 2008  
SUZUKI Splash 2008

MOCSKT 101

**MOCSRR0AC010 cm 110**

**MOCSRR0AL006 cm 110**

componenti:

1 - L1112/1 ant. sx



1 - L1032/2 post. sx



4 - RC20200026

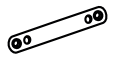

1 - L1112/2 ant. dx



4 - RC1500/45



1 - RCBR5



1 - L1032/1 post. dx



8 - RCVM6X9Q 9 mm



I - montare le guarnizioni

F - monter les joints

GB - fit the gaskets

D - Die Dichtungen einsetzen

E - montar las juntas

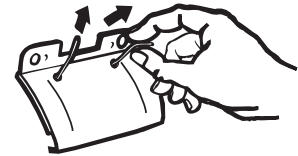
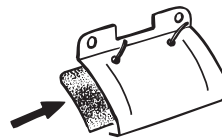

I - montare gli attacchi anteriori

F - monter les griffes avant

GB - fit the front clamps

D - Die vorne Klammern einsetzen

E - ajustar las pletinas delanteras

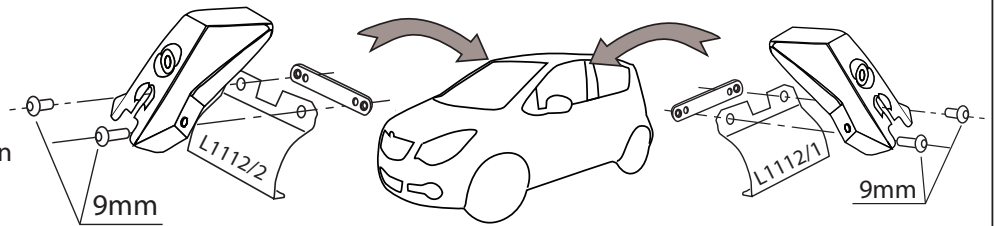

I - montare gli attacchi posteriori

F - monter les griffes arrière

GB - fit the rear clamps

D - Die hinten Klammern einsetzen

E - ajustar las pletinas trasera.

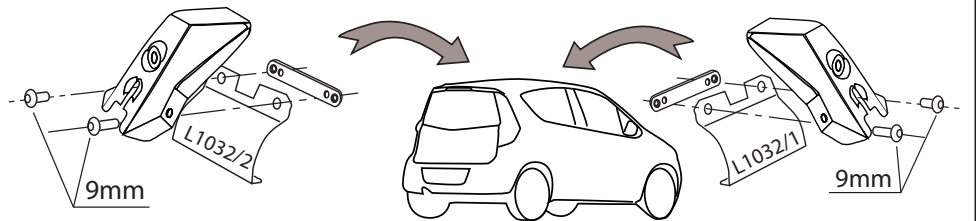

**MOCSRR0AC010 cm 110**

**MOCSRR0AL006 cm 110**

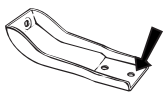

anteriore, avant, front,  
vorne, delantera

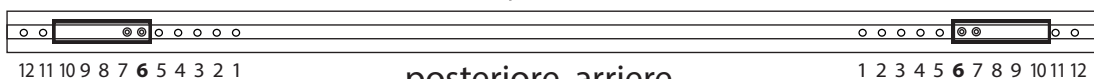
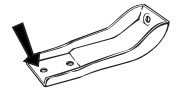

posteriore, arrière,  
rear, hinten, trasera

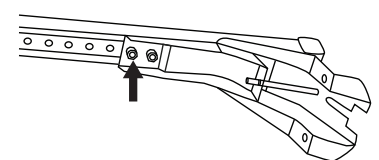
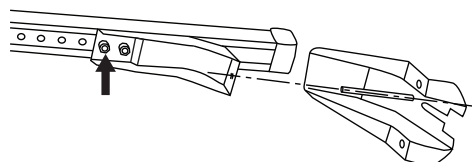
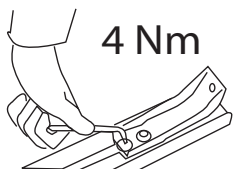

# MOCSKT 101

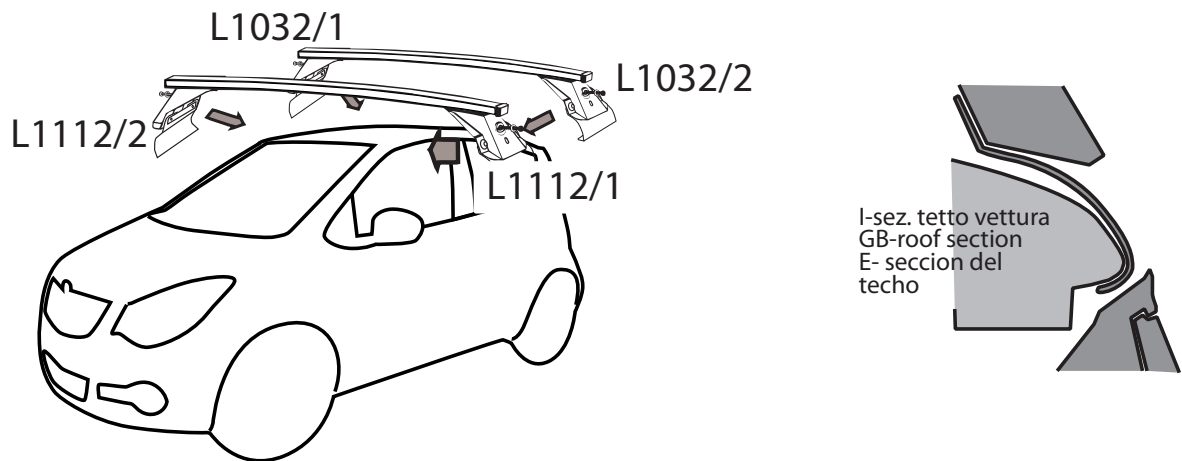
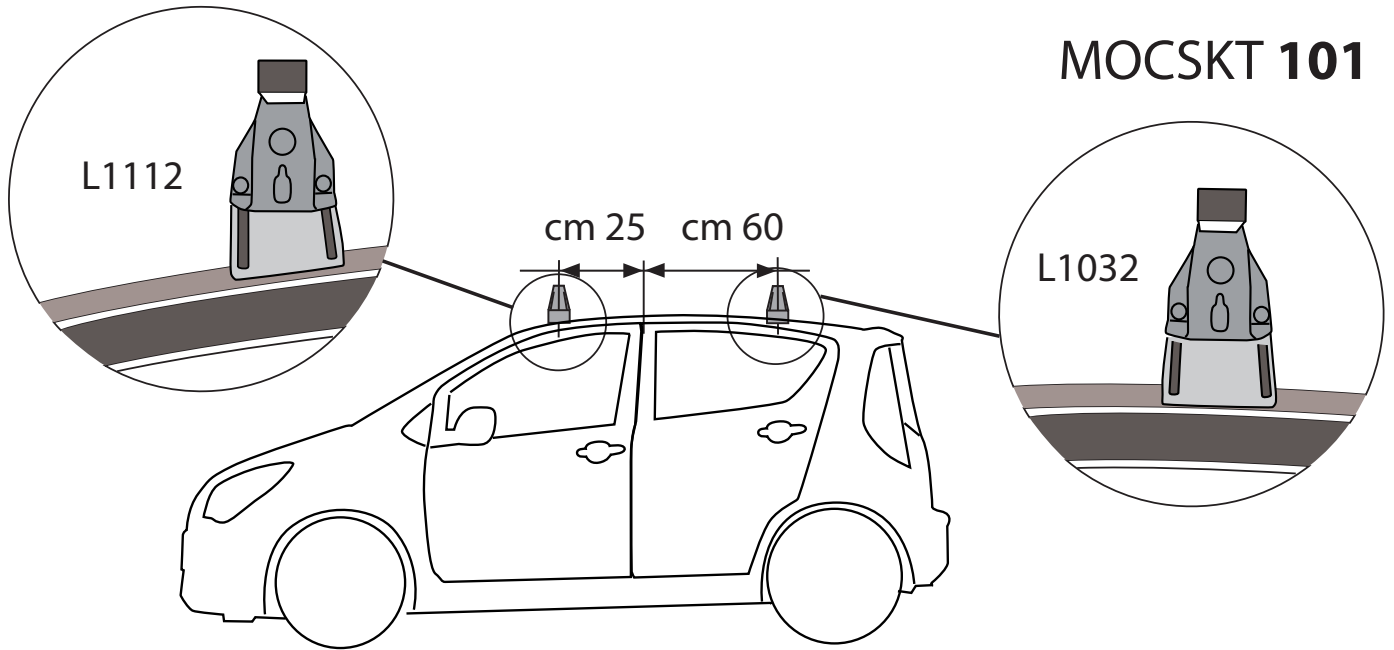

I - Per stringere, usare la chiave come indicato nel disegno. (Non si assumono responsabilità per danni causati dall'impiego di chiavi diverse da quella in dotazione al prodotto).

F - Pour serrer, utiliser la clé comme indique ci dessous.

GB - For tightening, please use the wrench as per the drawing.

D - Zum Anziehen benutzen Sie bitte den Inbusschlüssel, nur wie auf dem Bild dargestellt.

E - Para el correcto ajuste, utilizar la llave fija tal y como se indica en la imagen

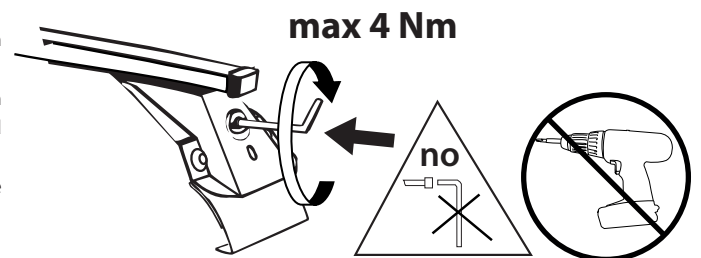

I Si raccomanda, dopo il montaggio e periodicamente di verificare il fissaggio. La ditta non si assume responsabilità per eventuali danni riportati da persone o cose dovuti al cattivo impiego dei suoi prodotti.

F On recommande, après le montage et périodiquement de vérifier le fixage. La maison décline toutes responsabilités pour éventuels dommages dus au mauvais emploi de ses produits.

GB We recommend after assembly and periodically to verify the fixing. The firm dont take responsibility for eventual damages or injury due to the bad use of his products.

D Es empfiehlt sich, dass ab und zu die richtige Befestigung überwacht werden. Unsere Firma haftet nicht für möglichen Schade zu Persone und Sachen wegen der unfähigen Anwendung unserer Erzeugnisse.

E Se recomienda verificar la sujeción periódicamente y después de cada montaje. La empresa no se hace responsable de los daños que se puedan ocasionar como consecuencia del mal uso de nuestros productos.

