

RENAULT Laguna model 2007

MOCSRROAC010 cm 110

MOCSRROAL006 cm 110

MOCSKT 095



componenti:					
2 - L1178/1 ant. sx post. dx		2 - L1061/4		8 - RCVMX9Q	
2 - L1178/2 ant.dx post. sx		2 - L1315/4		4 - RC20200026	
		4 - L1058/6		1 - RCBR5	

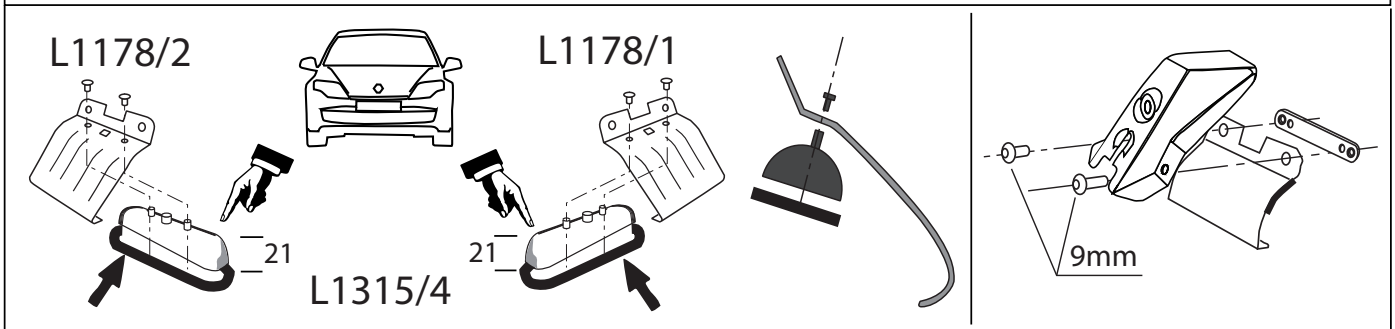

!!!



MOCSRROAC010 cm 110

MOCSRROAL006 cm 110

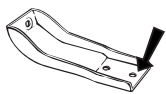

anteriore, avant, front,
vorne, delantera

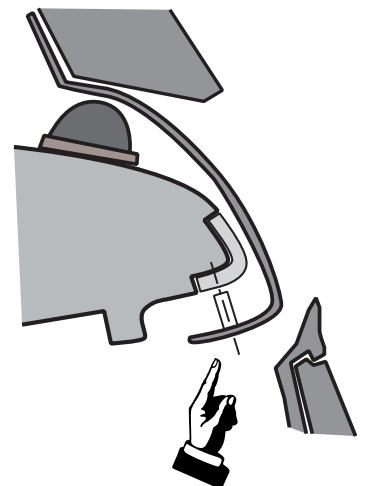
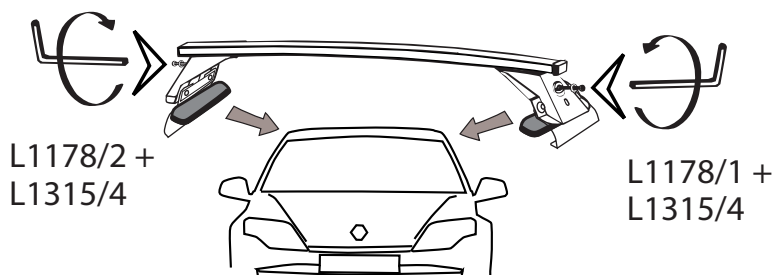
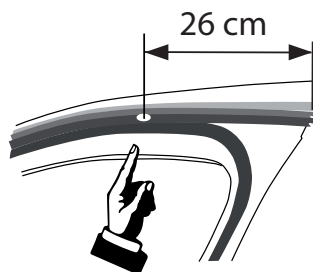
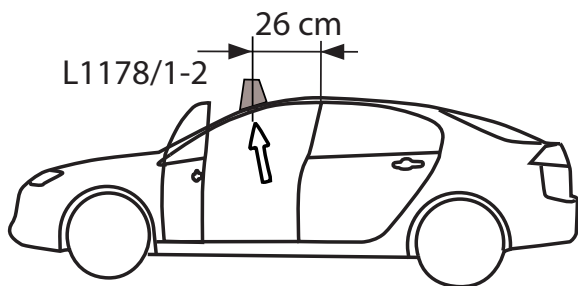
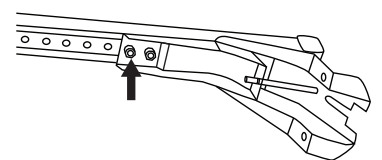
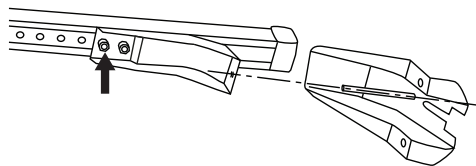
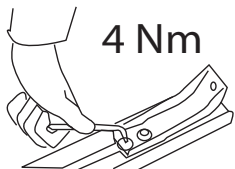
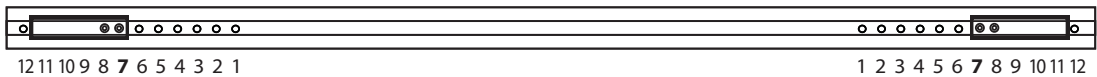
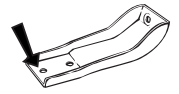

MOCSKT 095

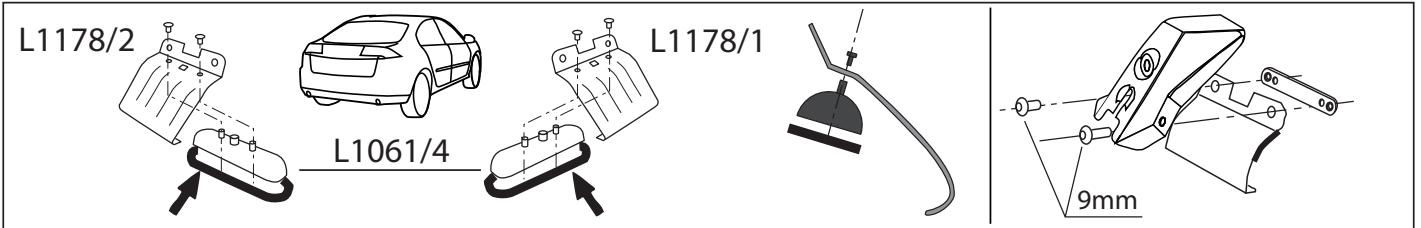

!!!



MOCSRR0AC010 cm 110 MOCSRR0AL006 cm 110

posteriore, arriere,
rear, hinten, trasera

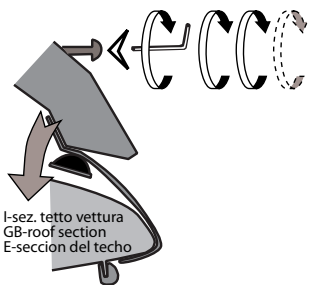
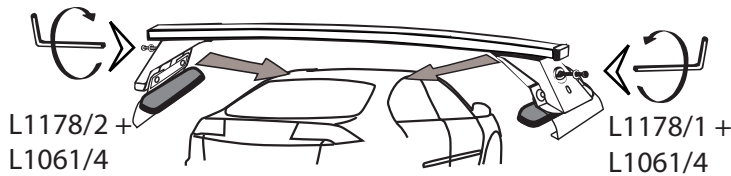
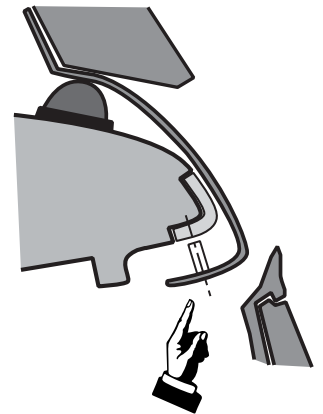
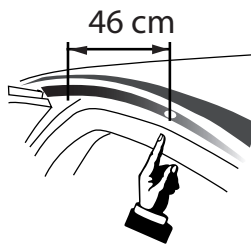
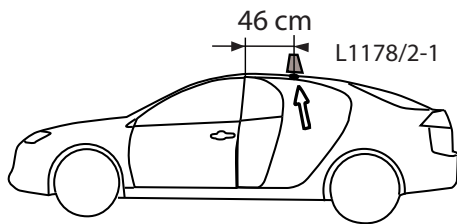
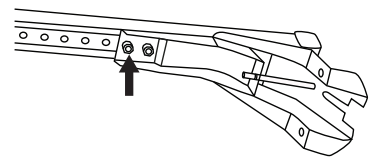
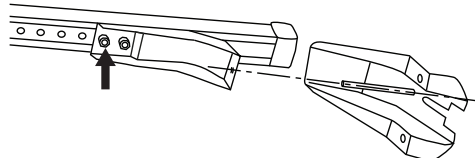
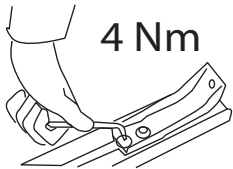
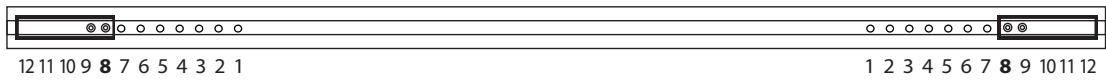
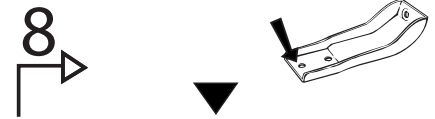
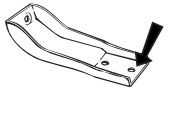

I-sez. tetto vettura
GB-roof section
E-seccion del techo



max 4 Nm

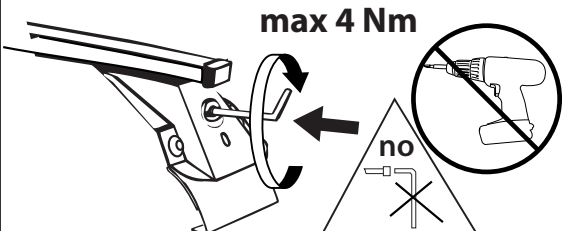

max 4 Nm

I - Per stringere, usare la chiave come indicato nel disegno. (Non si assumono responsabilità per danni causati dall'impiego di chiavi diverse da quella in dotazione al prodotto).

F - Pour serrer, utiliser la clé comme indique ci dessous.

GB - To tighten please use the wrench as per the drawing.

D - Zum Anziehen benutzen Sie bitte den Inbusschlüssel, nur wie auf dem Bild dargestellt.

E - Para el correcto ajuste, utilizar la llave fija tal y como se indica en la imagen