













VOLVO C 30 modello 2007

MOCSKT 069

**MOCSRR0AC011 cm 124**

**MOCSRR0AL007 cm 124**



- 1 - L1148/1 ant. sx 
- 1 - L1148/2 ant.dx 
- 2 - RC1500/45 ant. 
- 2 - L848/3 post. 
- 2 - RC1500/60 post. 
- 6 - RCVM6X9Q  9 mm
- 2 - RCVM6X13Q  13 mm
- 2 - RCVM6X12Q  12 mm
- 2 - RCRD6/20Q 
- 2 - RC20011935 
- 4 - RC20200026 
- 1 - RCBR5 
- 1 - RCBR4 

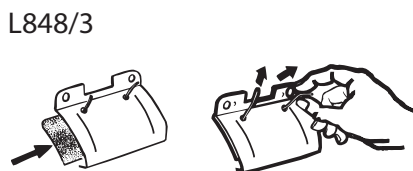
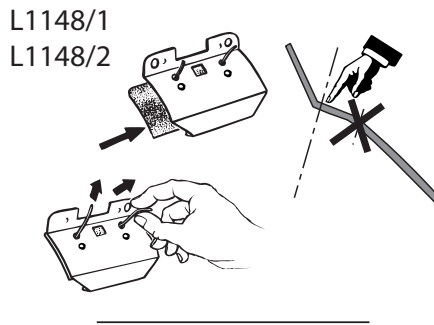

I-montare gli attacchi anteriori  
GB-fit the front clamps  
E- ajustar las pletinas delantera.

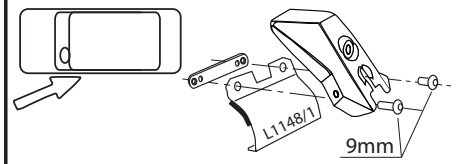
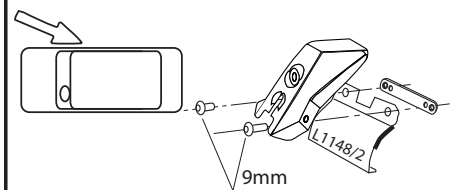

**MOCSRR0AC011 cm 124**  
**MOCSRR0AL007 cm 124**

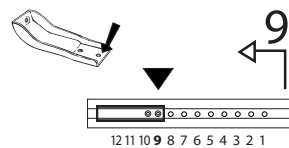

anteriore, avant, front,  
vorne, delantera

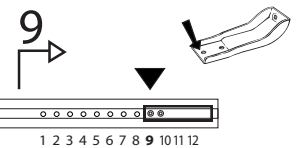

12 11 10 9 8 7 6 5 4 3 2 1

1 2 3 4 5 6 7 8 9 10 11 12

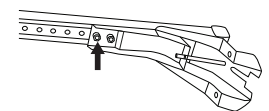
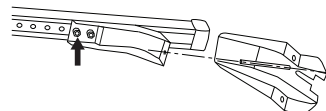

I-montare la barra anteriore.  
GB- fit the front bar.  
E- ajustar la barra frontal.

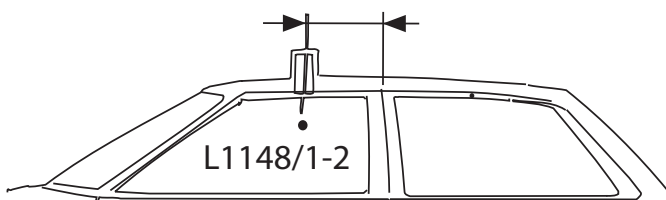
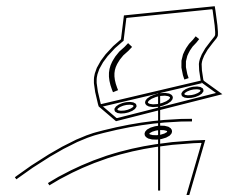
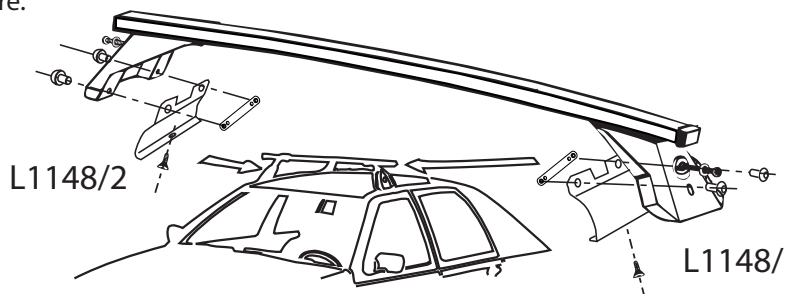
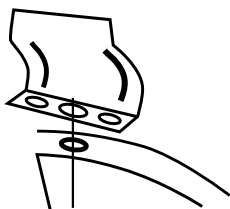

I-sez. tetto vettura  
GB-roof section  
E-seccion del techo



I-montare gli attacchi posteriori  
 GB-fit the reareclamps  
 E- ajustar las pletinas trasera.

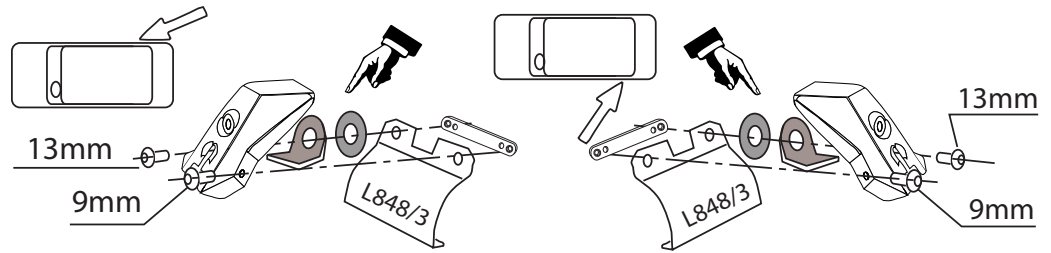

**MOCSRR0AC011 cm 124**  
**MOCSRR0AL007 cm 124**

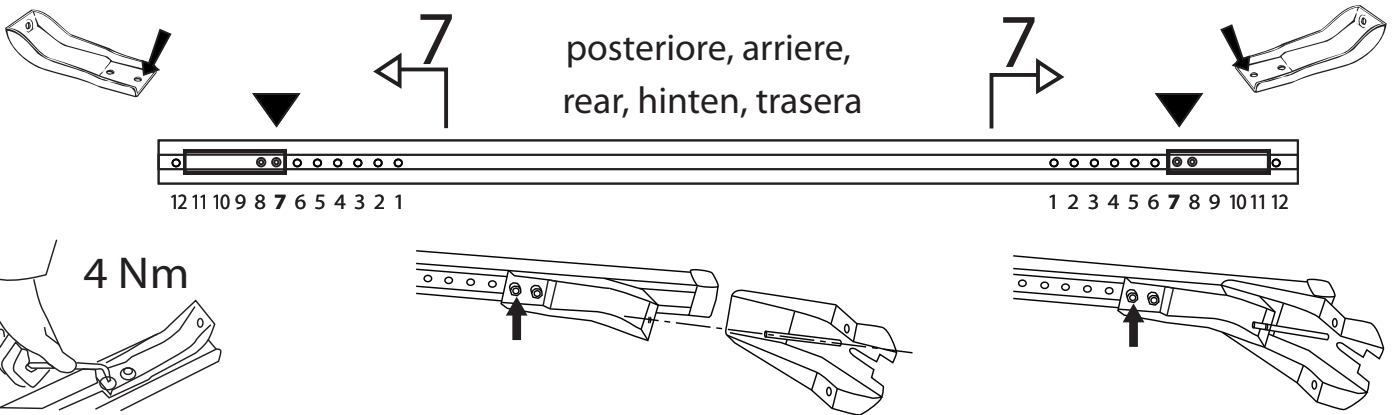

I-montare la barra posteriore  
 GB-fit the rear bar  
 E- ajustar la barra trasera

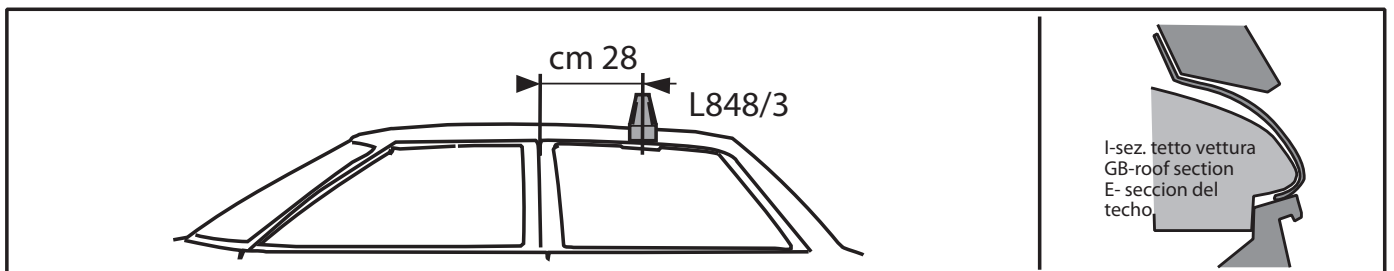
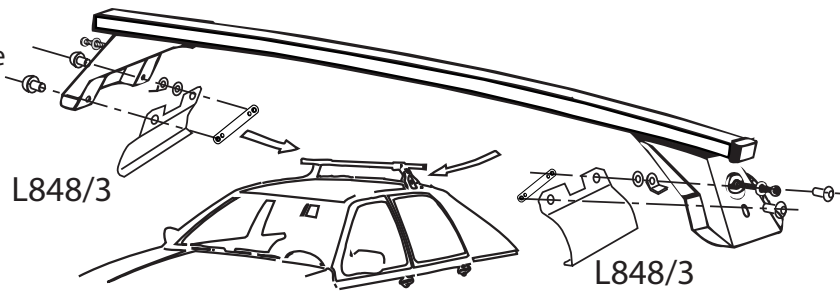

I - Per stringere, usare la chiave come indicato nel disegno. (Non si assumono responsabilità per danni causati dall'impiego di chiavi diverse da quella in dotazione al prodotto).  
 F - Pour serrer, utiliser la clé comme indique ci dessous.

GB - To tighten please use the wrench as per the drawing.  
 D - Zum Anziehen benutzen Sie bitte den Inbusschlüssel, nur wie auf dem Bild dargestellt.  
 E - Para el correcto ajuste, utilizar la llave fija tal y como se indica en la imagen

