

MOCSRR0AC010 cm 110

MOCSRR0AL006 cm 110

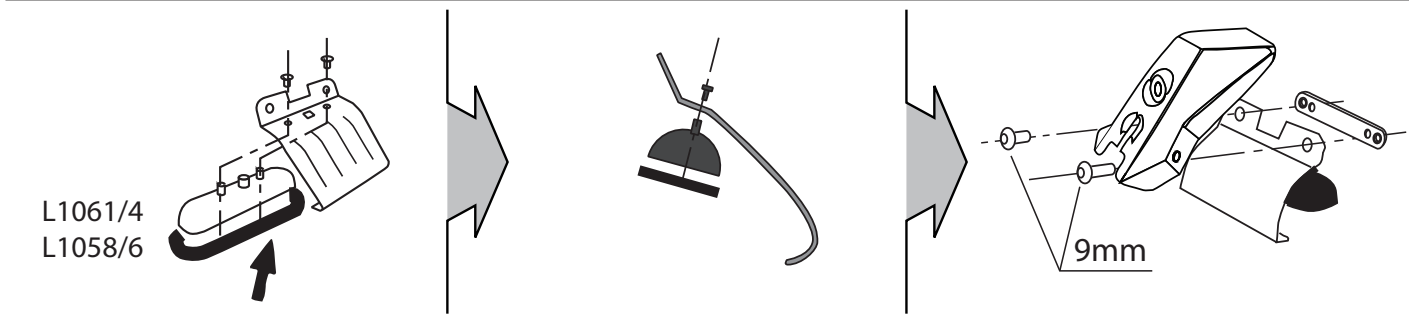

2 - L603/3 ant.		4 - L1061/4		8 - RCVM6X9Q	
2 - L1081 post.		4 - L1058/6		4 - RC20200026	
				1 - RCBR5	



MOCSRR0AC010 cm 110
MOCSRR0AL006 cm 110

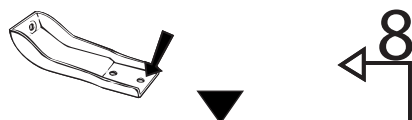

anteriore, avant, front,
vorne, delantera

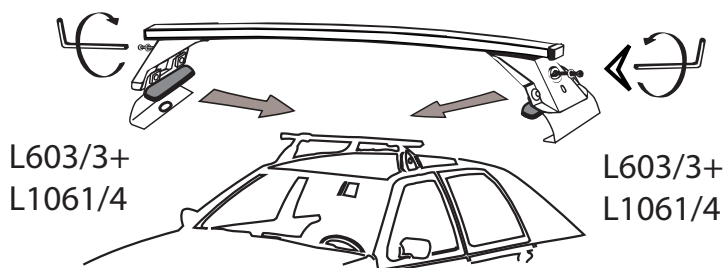
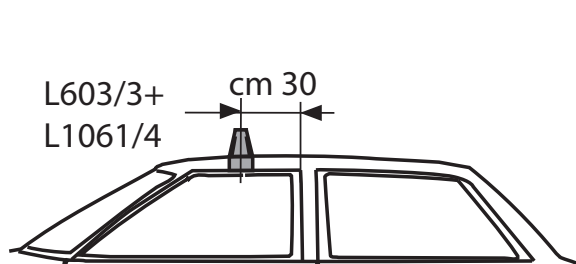
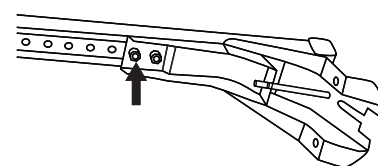
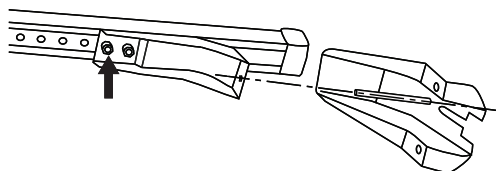
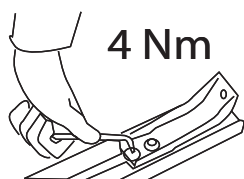
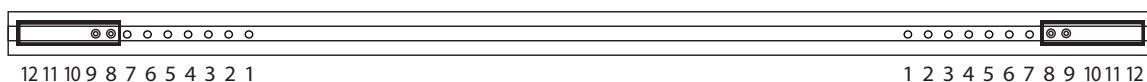
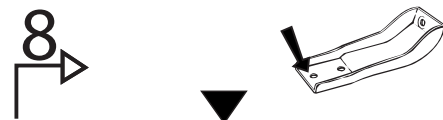

MOCSKT 062



MOCSRR0AC010 cm 110
MOCSRR0AL006 cm 110

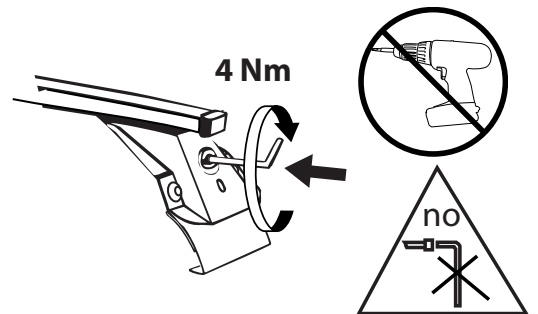
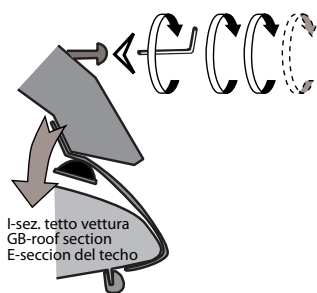
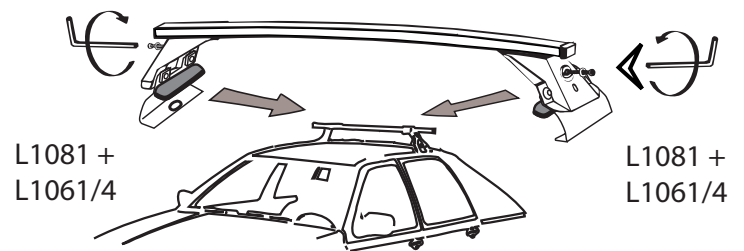
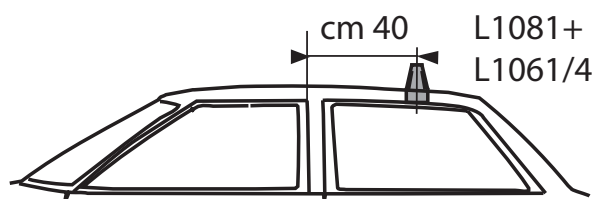
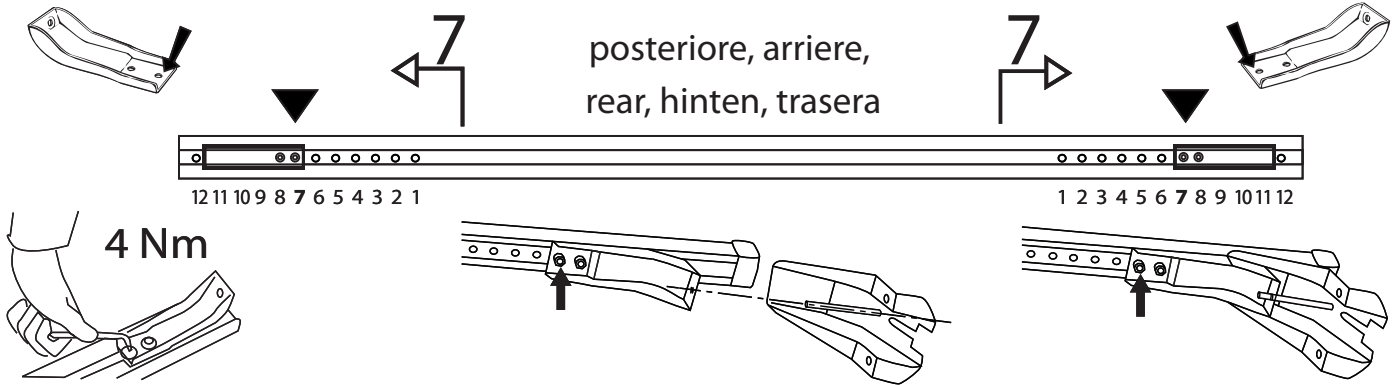

I - Per stringere, usare la chiave come indicato nel disegno. (Non si assumono responsabilità per danni causati dall' impiego di chiavi diverse da quella in dotazione al prodotto).

F - Pour serrer, utiliser la clé comme indique ci dessus.

GB - To tighten please use the wrench as per the drawing.

D - Zum Anziehen benutzen Sie bitte den Inbusschlüssel, nur wie auf dem Bild dargestellt.

E - Para el correcto ajuste, utilizar la llave fija tal y como se indica en la imagen



MODULA
case system

email: modulacs@modulacs.com
 web site: www.modulacs.com

Modula s.r.l.
 Loc. Penisola, 20/A
 61026 Piandimeleto (PU) ITALY
 phone +39 0722/700070
 fax +39 0722/720017

18-01-2016