









Toyota Yaris 5 porte modello 2006

MOCSKT 052

MOCSRR0AC010 cm 110

MOCSRR0AL006 cm 110

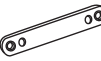

- 1 - L1124/1 
- 1 - L1124/2 
- 2 - L1124/3 
- 2 - RC1500/30 
- 2 - RC1500/45 
- 8 - RCVM6X9Q 
- 4 - RC20200026 
- 1 - RCBR5 

I - montare le guarnizioni
 F - monter les joints
 GB - fit the gaskets
 D - Die Dichtungen einsetzen
 E - montar las juntas

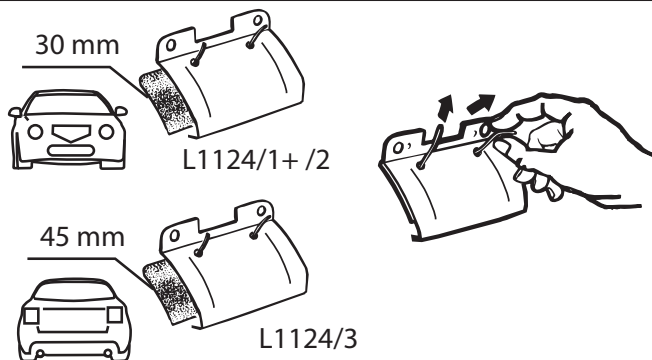

I - montare gli attacchi
 F - monter les griffer
 GB - fit the clamps
 D - Die Klammern einsetzen
 E - ajustar las pletinas

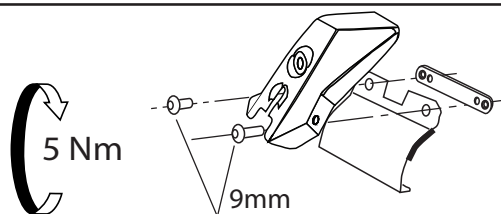

MOCSRR0AC010 cm 110

MOCSRR0AL006 cm 110

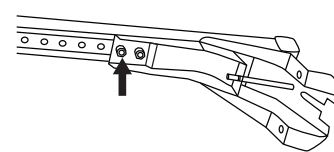
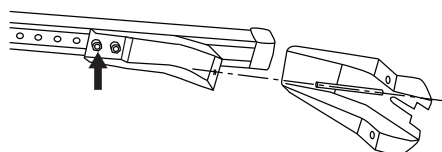
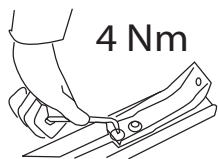
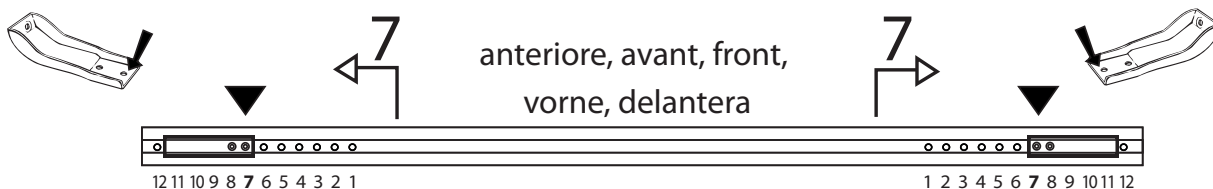

I - montare la barra anteriore
 GB - fit the front bar
 E - ajustar la barra frontal

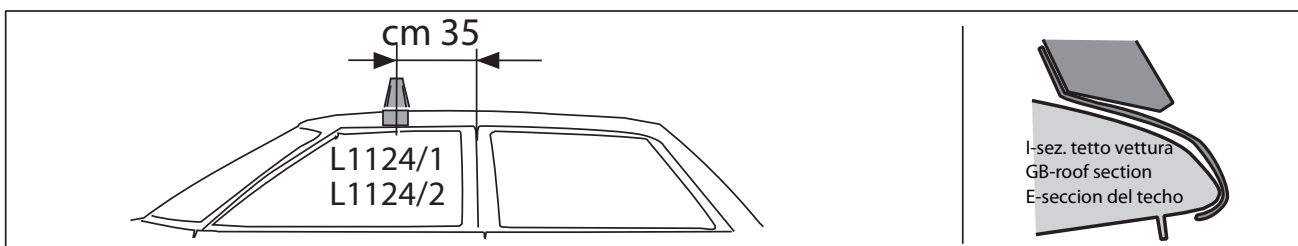
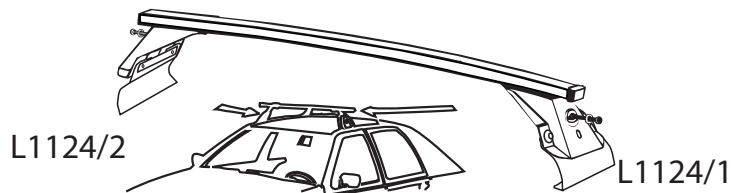

MOCSKT 052

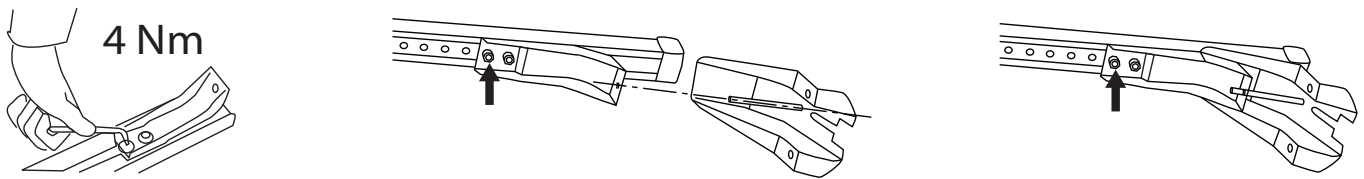
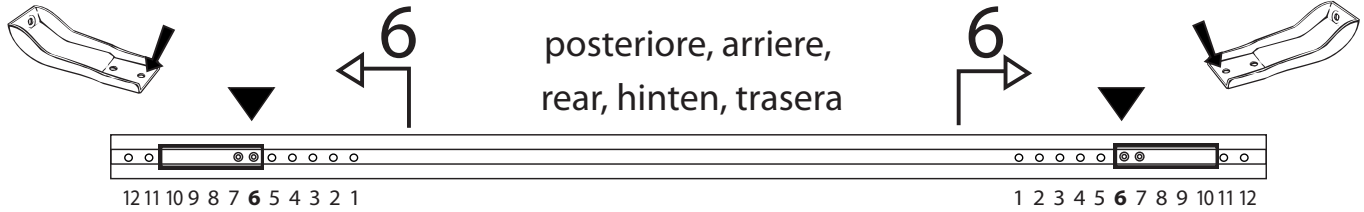

I-montare la barra posteriore
GB-fit the rear bar
E- ajustar la barra trasera

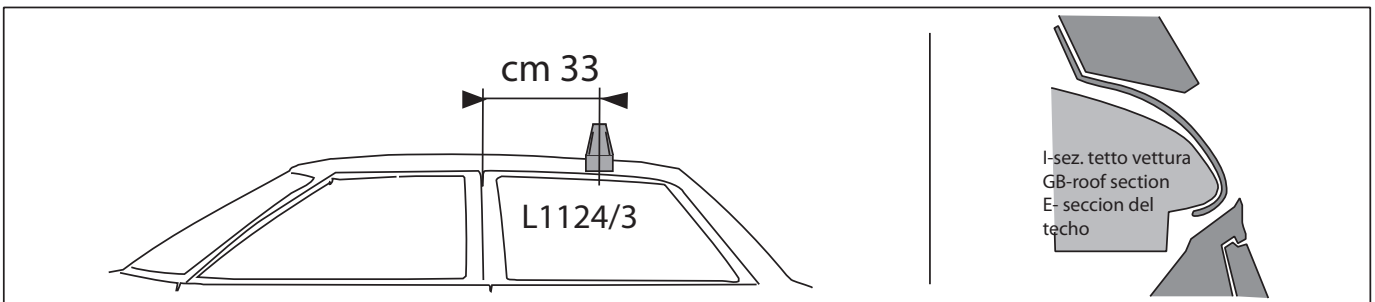
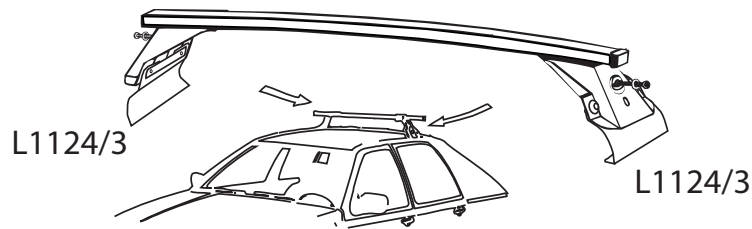

I - Per stringere, usare la chiave come indicato nel disegno. (Non si assumono responsabilità per danni causati dall'impiego di chiavi diverse da quella in dotazione al prodotto).
F - Pour serrer, utiliser la clé comme indique ci dessous.

GB - To tighten please use the wrench as per the drawing.
D - Zum Anziehen benutzen Sie bitte den Inbusschlüssel, nur wie auf dem Bild dargestellt.
E - Para el correcto ajuste, utilizar la llave fija tal y como se indica en la imagen

