

Fiat Grande Punto 5 porte modello 2005  
 Fiat Punto Evo 5 porte modello 2009

**MOCSKT 045**



**MOCSRROAC010 cm 110**

**MOCSRROAL006 cm 110**



- componenti:
- 1 - L1116/1
  - 1 - L1116/2
  - 2 - RC1500/60
  - 2 - L1043
  - 2 - RC1500/95
  - 8 - RCVM6X9Q
  - 2 - RCVM6X13Q
  - 4 - RC20200026
  - 1 - RCBR5

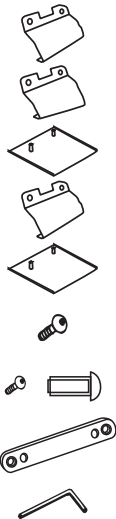

I-montare le guarnizioni  
 GB-fit the gaskets  
 E- montar las juntas

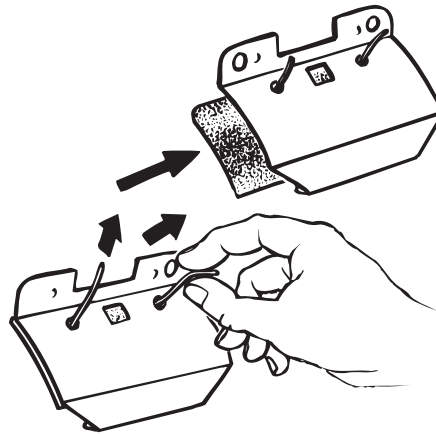

I-montare gli attacchi  
 GB-fit the clamps  
 E- ajustar las pletinas

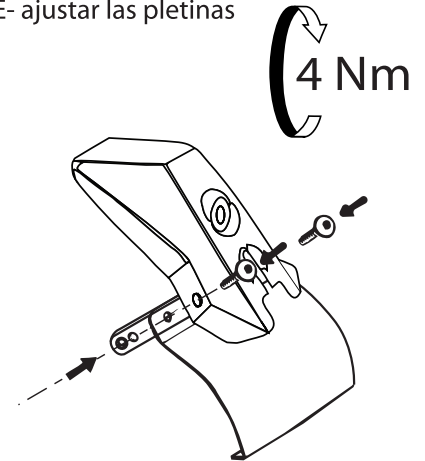

!!!



**MOCSRROAC010 cm 110**

**MOCSRROAL006 cm 110**

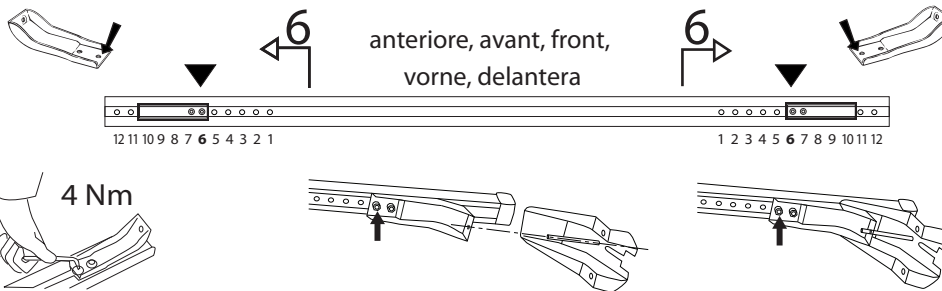

I-montare la barra anteriore  
 GB- fit the front bar  
 E- ajustar la barra frontal

L1116/2



L1116/1

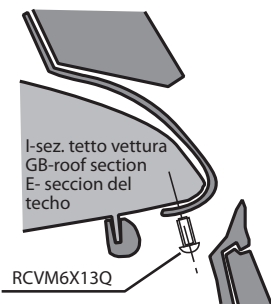
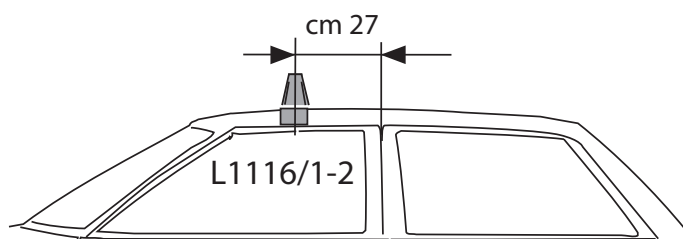



**MOCSRROAC010 cm 110**  
**MOCSRROAL006 cm 110**

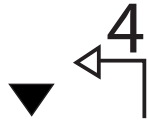
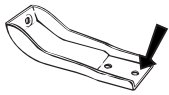

posteriore, arriere,  
 rear, hinten, trasera

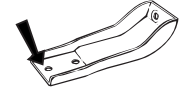
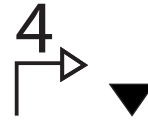

12 11 10 9 8 7 6 5 4 3 2 1

1 2 3 4 5 6 7 8 9 10 11 12

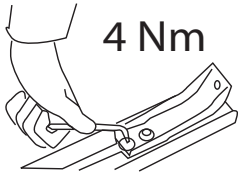

4 Nm

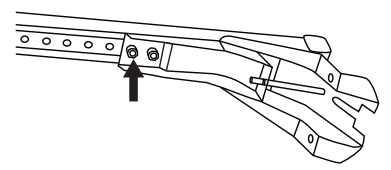
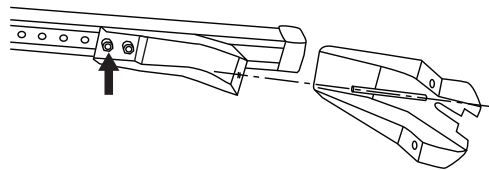

I-montare la barra posteriore  
 GB-fit the rear bar  
 E- ajustar la barra trasera



L1043

L1043

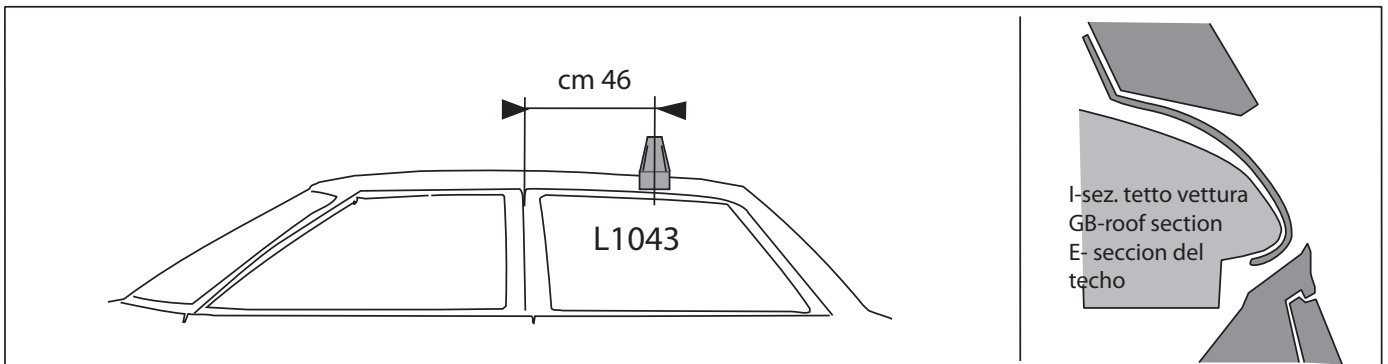

cm 46

L1043

I-sez. tetto vettura  
 GB-roof section  
 E- seccion del  
 techo

I - Per stringere, usare la chiave come indicato nel disegno. (Non si assumono responsabilità per danni causati dall'impiego di chiavi diverse da quella in dotazione al prodotto).  
 F - Pour serrer, utiliser la clé comme indique ci dessous.

GB - To tighten please use the wrench as per the drawing.  
 D - Zum Anziehen benutzen Sie bitte den Inbusschlüssel, nur wie auf dem Bild dargestellt.  
 E - Para el correcto ajuste, utilizar la llave fija tal y como se indica en la imagen

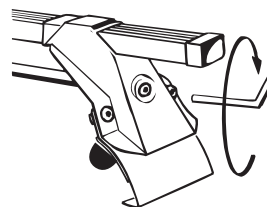

max 4 Nm

