

Fiat Grande Punto 3 porte modello 2005

MOCSKT 044

Fiat Punto Evo 3 porte modello 2009



MOCSRR0AC010 cm 110

MOCSRR0AL006 cm 110

1 - L1116/1 ant. sx



2 - RC1500/60



2 - L1061/4



1 - L1116/2 ant. dx



8 - RCVM6X9Q

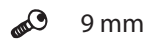

2 - L1058/6

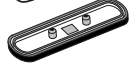

2 - L1116/3



2 - RCVM6X13Q

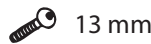

4 - RC20200026



1 - RCBR5

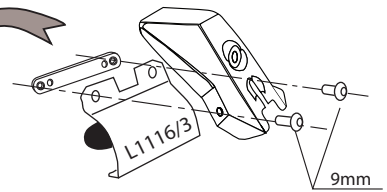
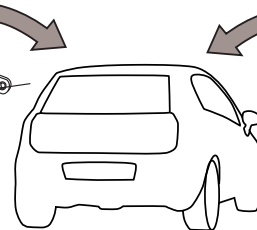
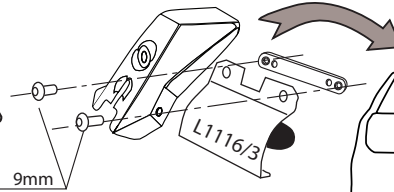
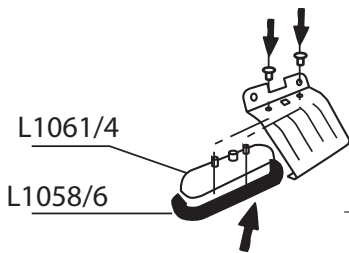
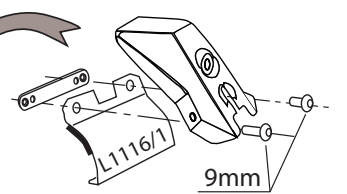
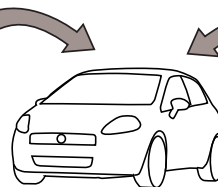
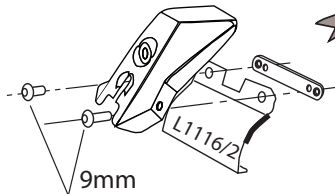
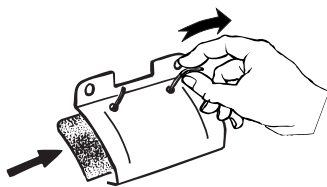

MOCSRR0AC010 cm 110

MOCSRR0AL006 cm 110

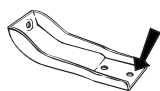

anteriore, avant, front,
vorne, delantera

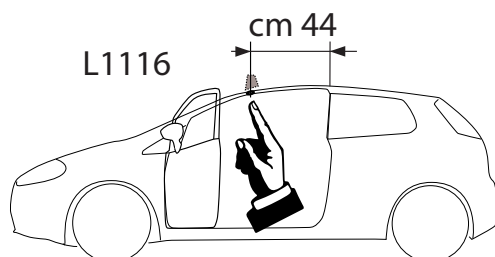
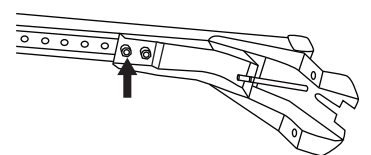
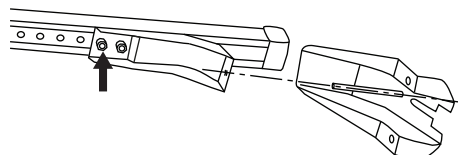
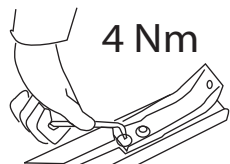
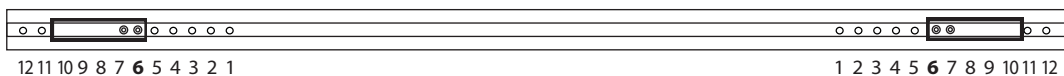
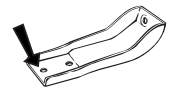

I-sez. tetto vettura
GB-roof section
E- seccion del
techo



MOCSKT 044

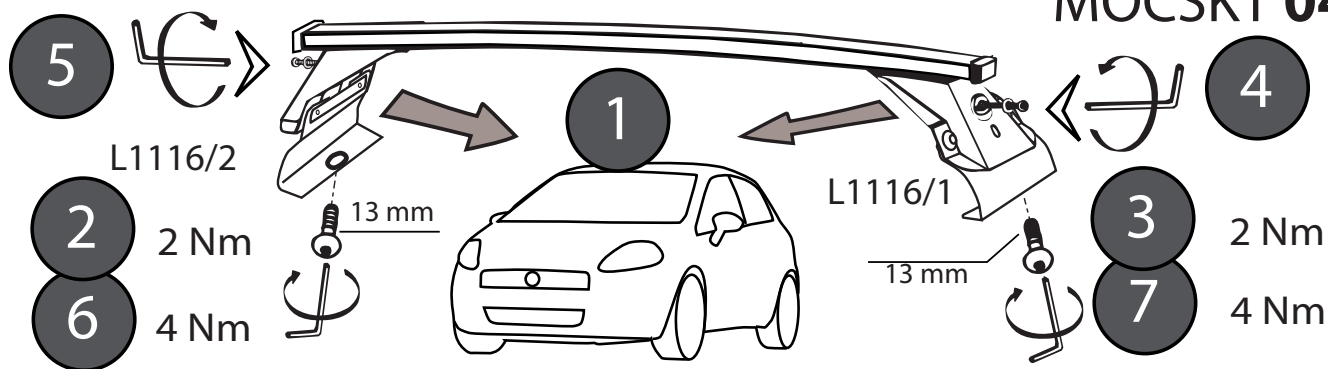

MOCSRROAC010 cm 110 MOCSRROAL006 cm 110

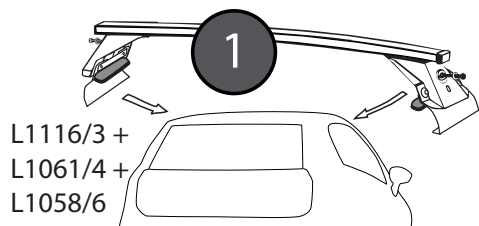
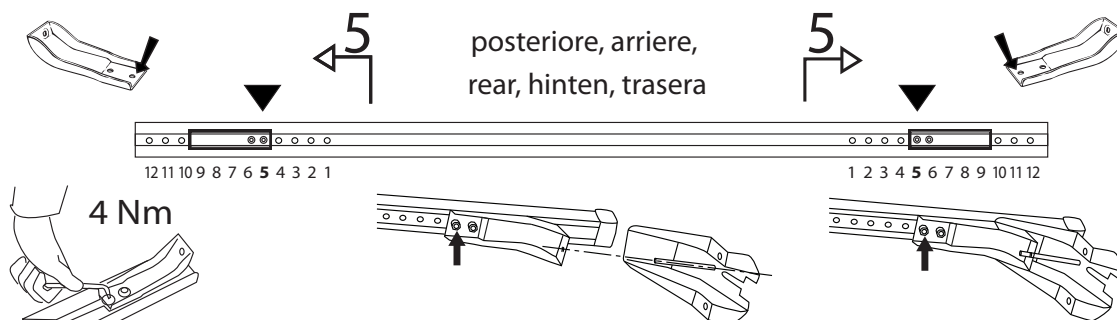

L1116/3 +
L1061/4 +
L1058/6

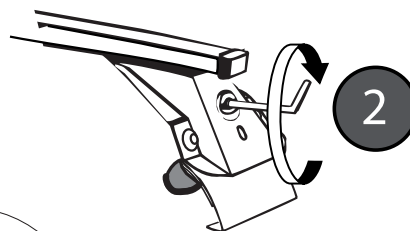

L1116/3 +
L1061/4 +
L1058/6

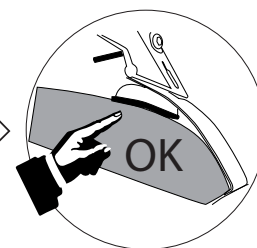
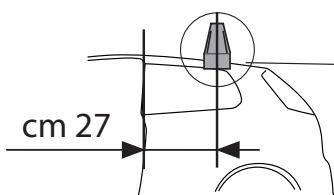

I - Per stringere, usare la chiave come indicato nel disegno. (Non si assumono responsabilità per danni causati dall'impiego di chiavi diverse da quella in dotazione al prodotto).

F - Pour serrer, utiliser la clé comme indique ci dessous.

GB - To tighten please use the wrench as per the drawing.

D - Zum Anziehen benutzen Sie bitte den Inbusschlüssel, nur wie auf dem Bild dargestellt.

E - Para el correcto ajuste, utilizar la llave fija tal y como se indica en la imagen

max 4 Nm

