

AUDI A4 berlina modello 2005  
SEAT Exeo berlina modello 2009

**MOCSKT 040**

**MOCSRR0AC010 cm 110**

**MOCSRR0AL006 cm 110**

<p>componenti:</p> <p>4 - L799/3</p> <p>4 - L1061/4</p> <p>4 - L1058/5</p> <p>6 - RCVM6X9Q</p> <p>2 - RCVM6X13Q</p> <p>4 - RC20200026</p> <p>4 - RCRD6Q</p> <p>1 - RCBRS</p>	<p>I-montare le guarnizioni GB-fit the gaskets E- montar las juntas</p>	<p>I-montare gli attacchi anteriori GB-fit the front clamps E- ajustar las pletinas delantera.</p>
--	---	--



**MOCSRR0AC010 cm 110**  
**MOCSRR0AL006 cm 110**

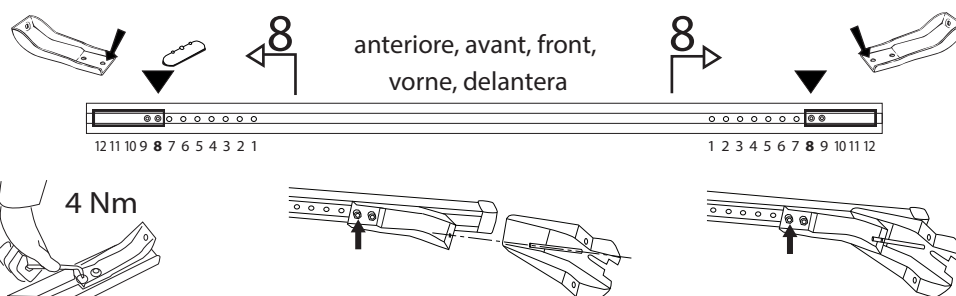

I-montare la barra anteriore  
GB- fit the front bar  
E- ajustar la barra frontal

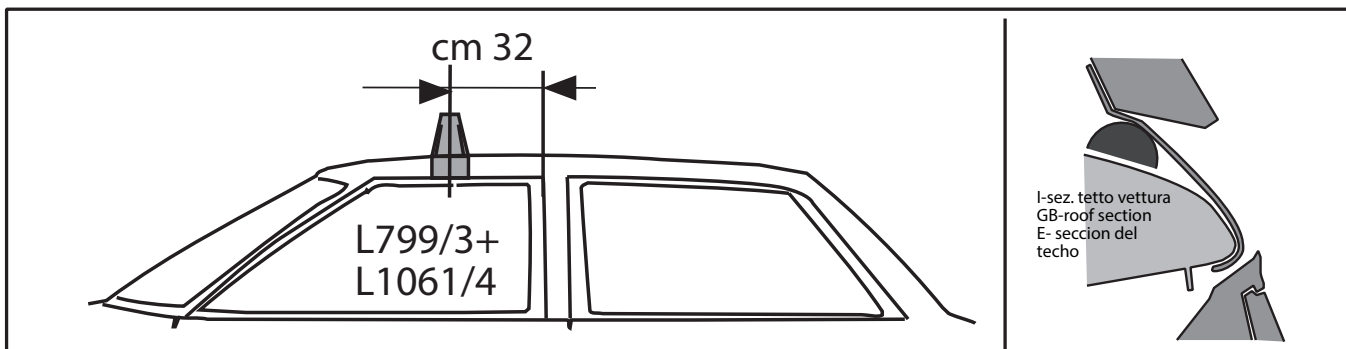
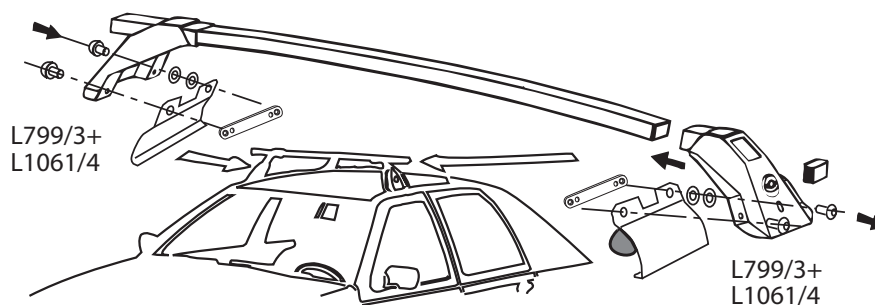

# MOCSKT 040



I-montare le guarnizioni  
GB-fit the gaskets  
E- montar las juntas

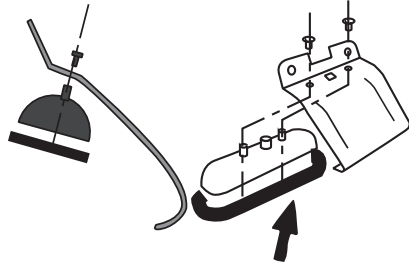

I-montare gli attacchi  
posteriori  
GB-fit the rear  
clamps  
E- ajustar las  
pletinas Traseras

4 Nm

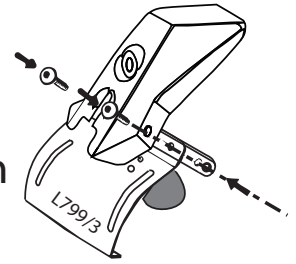

!!!



## MOCSRR0AC010 cm 110

## MOCSRR0AL006 cm 110

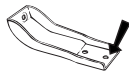

posteriore, arriere,  
rear, hinten, trasera

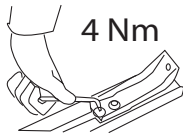
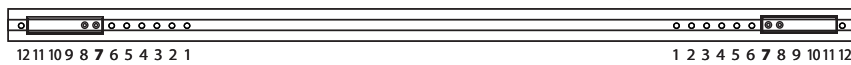
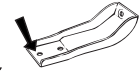

4 Nm

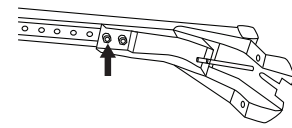
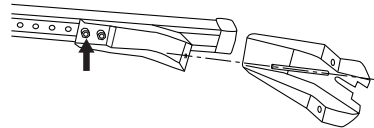

I-montare la barra posteriore  
GB-fit the rear bar  
E- ajustar la barra trasera

L799/3+  
L1061/4

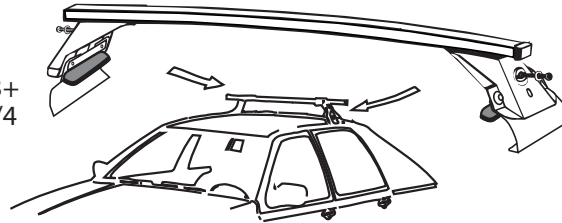

L799/3+  
L1061/4

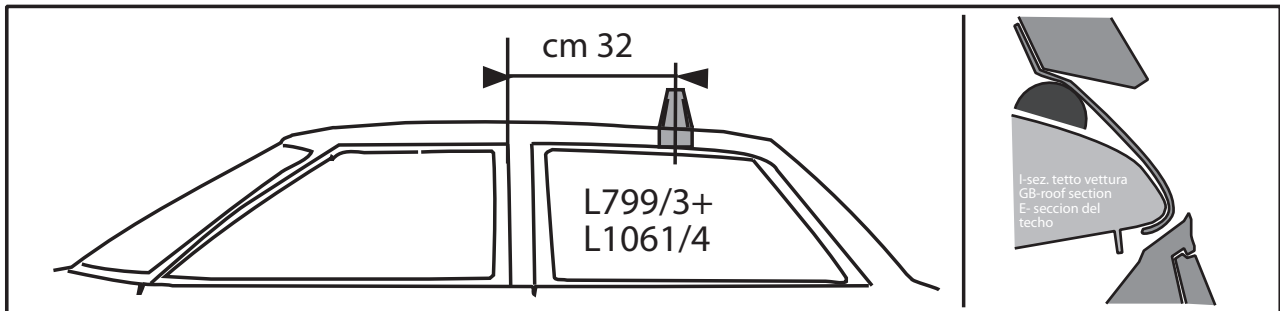

I- Per stringere, usare la chiave  
come indicato nel disegno. (Non si  
assumono responsabilità per danni  
causati dall' impiego di chiavi diverse  
da quella in dotazione al prodotto).

F- Pour serrer, utiliser la cle  
comme indique ci dessous.  
GB-For tightening, please use the  
wrench as per the drawing.

D- Zum Anziehen benutzen Sie bitte  
den Inbusschlüssel, nur wie auf dem  
Bild dargestellt.

E- Para el correcto ajuste, utilizar la llave fija  
tal y como se indica en la imagen.

max 4 Nm

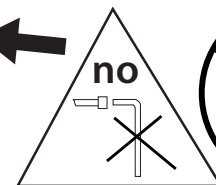
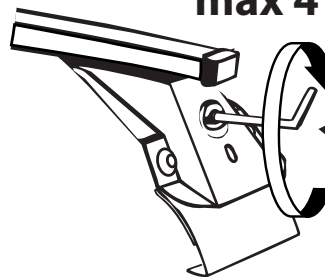

max  
Kg. 60



**MODULA**  
case system

email: modulacs@modulacs.com  
web site: www.modulacs.com

Modula s.r.l.  
Loc. Penisola, 20/A  
61026 Piandimeleto (PU) ITALY  
phone +39 0722/700070  
fax +39 0722/720017

18-01-2016