

VW FOX modello 2005

**MOSKT 037**

**MOCSRR0AC010 cm 110**  
**MOCSRR0AL006 cm 110**



<ul style="list-style-type: none"> <li>2 - L1108</li> <li>2 - L1108/3</li> <li>4 - RC1500/30</li> <li>8 - RCVM6X9Q</li> <li>2 - RCVM6x12Q</li> <li>4 - RC20200026</li> <li>1 - RCBR5</li> <li>1 - RCBR4</li> </ul>	<p>I-montare le guarnizioni          GB-fit the gaskets          E- montar las juntas</p>	<p>I-montare gli attacchi          GB-fit the clamps          E- ajustar las pletinas</p>
--	---	---



**MOCSRR0AC010 cm 110**  
**MOCSRR0AL006 cm 110**

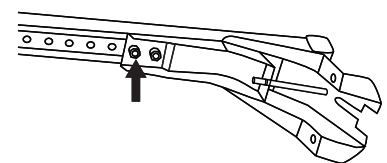
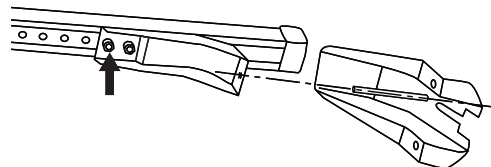
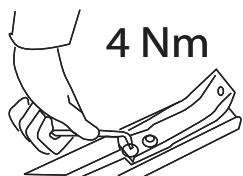
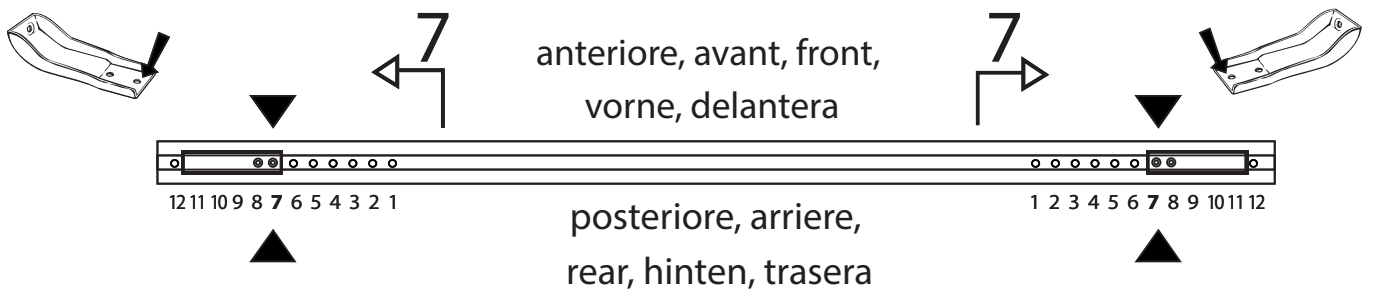

I-montare la barra anteriore.  
 GB- fit the front bar.  
 E- ajustar la barra frontal.

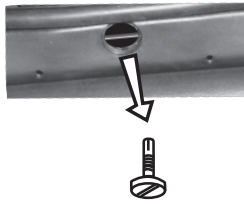
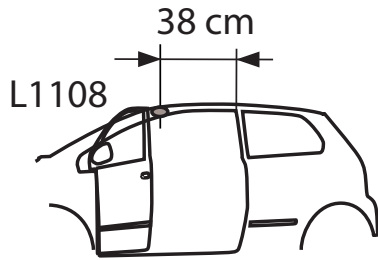

## MOSKT 037

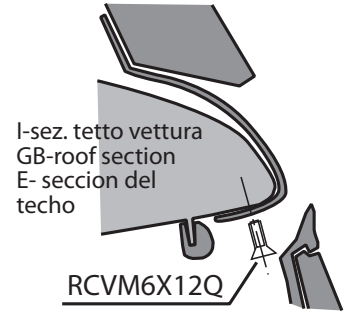
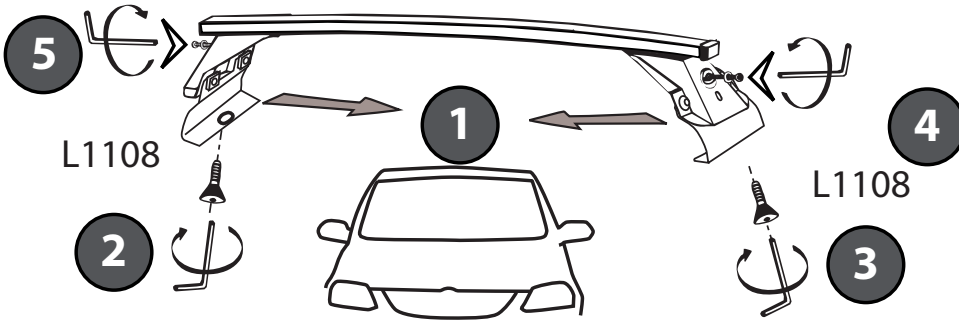
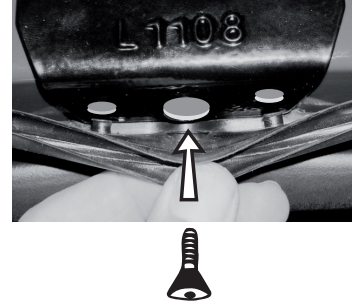

I-montare la barra posteriore  
 GB-fit the rear bar  
 E- ajustar la barra trasera

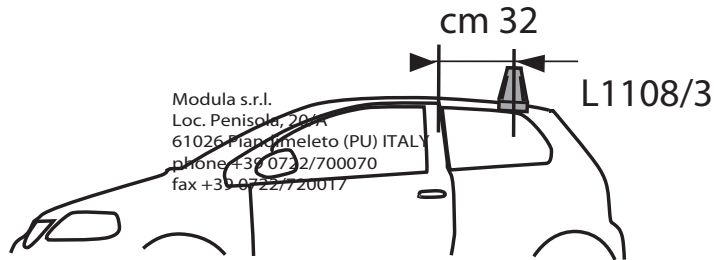

Modula s.r.l.  
 Loc. Penisola, 20/A  
 61026 Piandimeleto (PU) ITALY  
 phone +39 0722/700070  
 fax +39 0722/720017

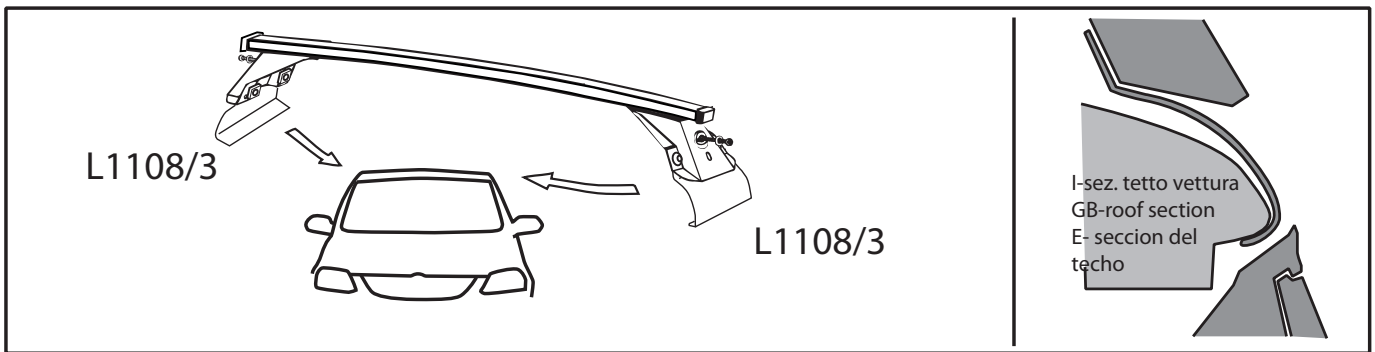

I - Per stringere, usare la chiave come indicato nel disegno. (Non si assumono responsabilità per danni causati dall'impiego di chiavi diverse da quella in dotazione al prodotto).  
 F - Pour serrer, utiliser la clé comme indique ci dessus.

GB - To tighten please use the wrench as per the drawing.  
 D - Zum Anziehen benutzen Sie bitte den Inbusschlüssel, nur wie auf dem Bild dargestellt.  
 E - Para el correcto ajuste, utilizar la llave fija tal y como se indica en la imagen

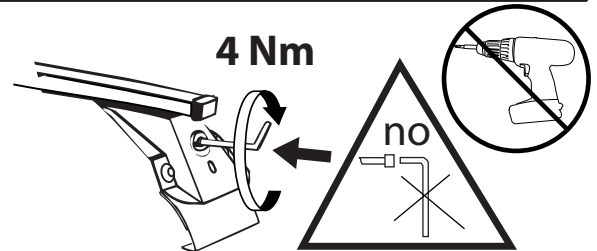

**MODULA**  
 case system  
 email: modulacs@modulacs.com  
 web site: www.modulacs.com

Modula s.r.l.  
 Loc. Penisola, 20/A  
 61026 Piandimeleto (PU) ITALY  
 phone +39 0722/700070  
 fax +39 0722/720017

18-01-2016