

L1565 PEUGEOT 2008 model 2019
no rails - senza mancorrenti

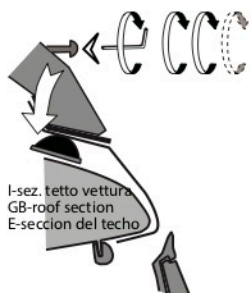

Patent pending

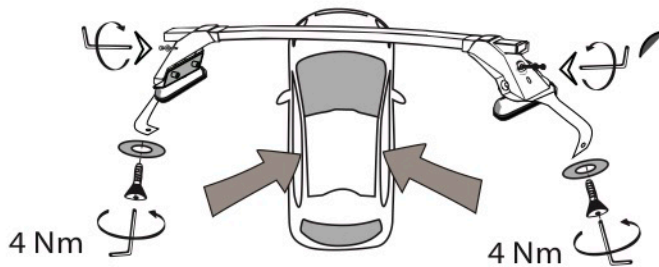
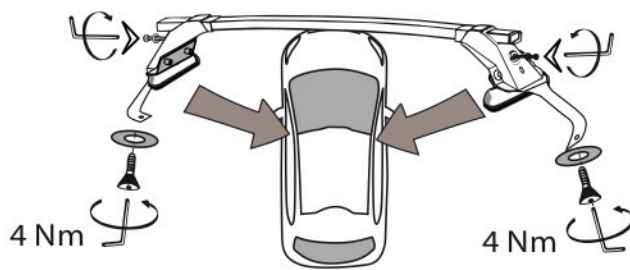
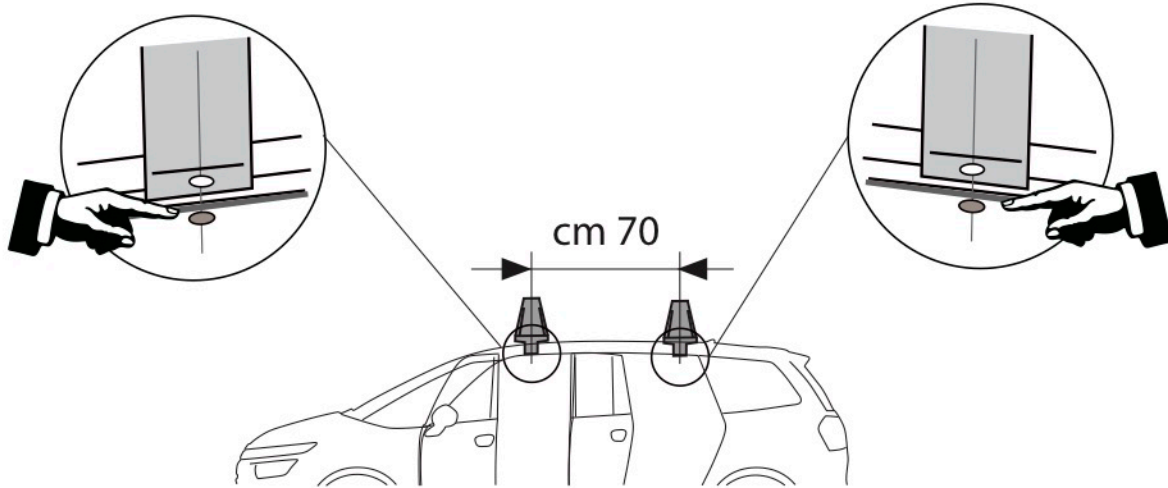
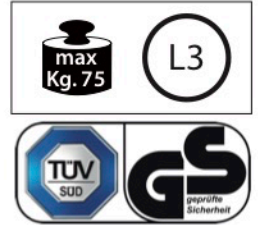

I-sez. tetto vettura
GB-roof section
E-seccion del techo

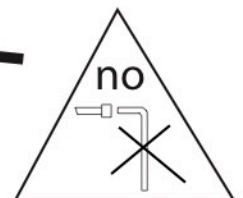
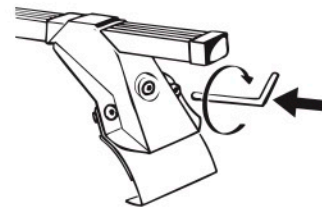

LA PREALPINA srl

INDUSTRIA ACCESSORI AUTO
10040 VOLVERA (Torino) ITALY
Strada Orbassano, 47
tel. 011 985 06 83, Fax 011 985 72 76
<http://www.laprealpina.net>; e-mail: lp@laprealpina.it

16/02/2021
Rev. 0