

cm 20

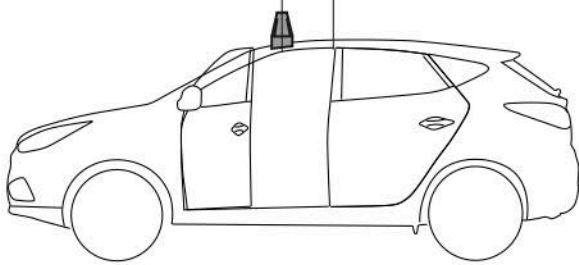

cm 50

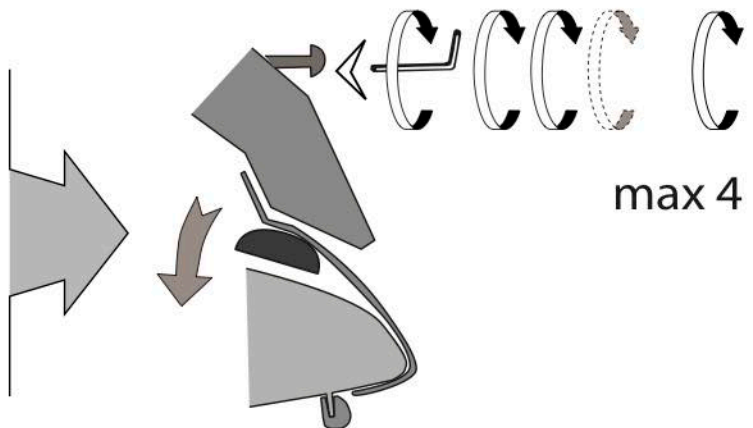
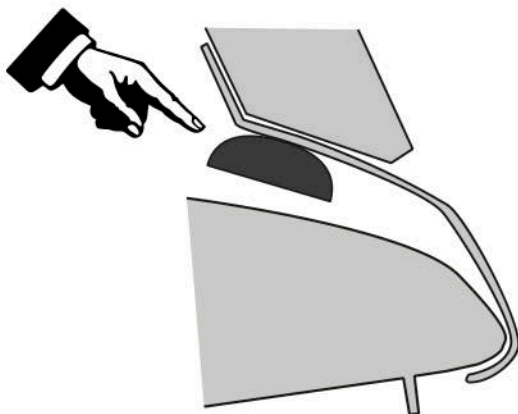
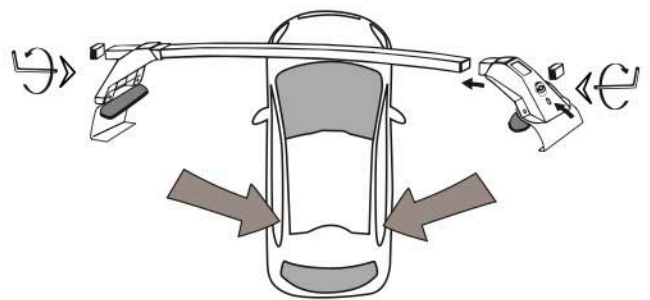
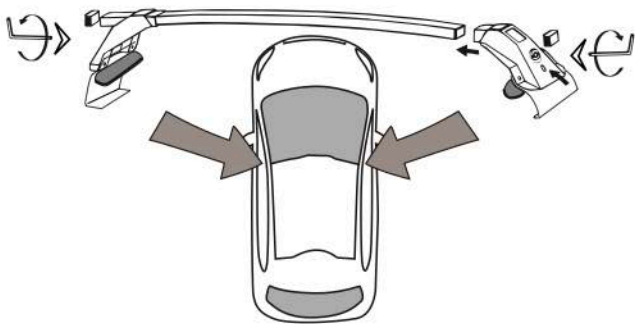
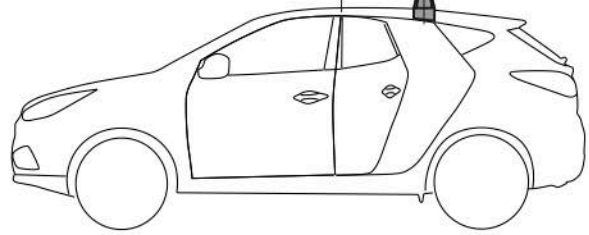

max 4 Nm

I - Per stringere, usare la chiave come indicato nel disegno. (Non si assumono responsabilità per danni causati dall'impiego di chiavi diverse da quella in dotazione al prodotto).  
F - Pour serrer, utiliser la clé comme indique ci dessous.

GB - To tighten please use the wrench as per the drawing.  
D - Zum Anziehen benutzen Sie bitte den Inbusschlüssel, nur wie auf dem Bild dargestellt.  
E - Para el correcto ajuste, utilizar la llave fija tal y como se indica en la imagen

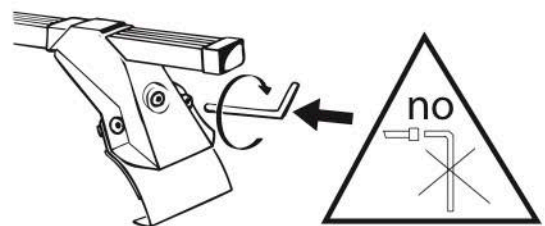

LA PREALPINA srl

INDUSTRIA ACCESSORI AUTO  
10040 VOLVERA (Torino) ITALY  
Strada Orbassano, 47  
tel. 011 985 06 83, Fax 011 985 72 76  
<http://www.laprealpina.net>; e-mail: [lp@laprealpina.it](mailto:lp@laprealpina.it)

05/07/2018  
Rev. 0