

➤ Instructions

Thule DockGlide

896

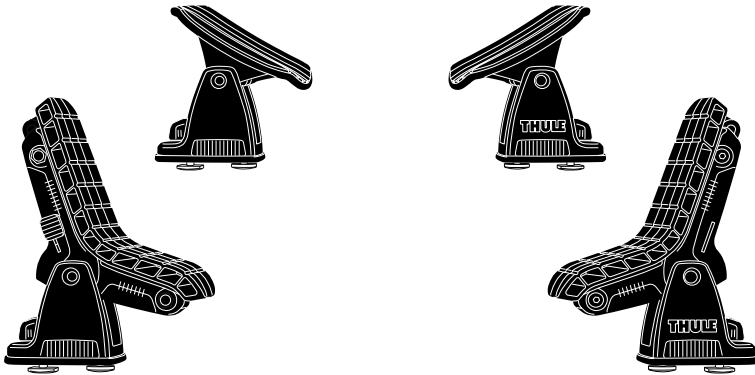

EN Roof mounted kayak carrier
FR Porte-kayak
ES Portakayak de techo
DE Kajakträger zur Dachmontage
NL Kajakdrager
PT Suporte de caiaques para montagem no tejadilho
IT Porta kayak da installare sul tetto
SV Takmonterad kajakhållare
DK Tagmonteret kajakholder
NO Takmontert kajakkstativ
FI Katolle asennettava kajakkitteline
IS Þakgrind fyrir kajak
ET Katusele paigaldatav süstahoidik
LV Uz jumta uzstādāms kajaku turētājs
LT Ant stogo tvirtinamas baidarių laikiklis
RU Крепление для каяка
UK Кріплення для перевезення каяків на даху
PL Uchwyt na kajak montowany na dachu
CS Nosič kajaků pro montáž na střechu
HU Tetőre szerelhető kajakszállító
RO Suport pentru caiac montat pe acoperiș
SK Strešný nosič kajakov
SL Strešni nosilec za kajak

BG Багажник за каяк, монтиран върху покрива
HR Krovni nosač kajaka
EL Σχάρα οροφής για καγιάκ
TR Araç üstüne bağlanan kayak taşıyıcı
MT Pembawa kayak yang dipasang pada bumbung
HE מנשא קייק לגג הרכב
AR حامل مثبت على السقف للزوارق

ZH (CN) 顶置皮艇托架
ZH (TW) 車頂獨木舟支架
JA ルーフマウント型カヤックキャリア
KO 루프 장착 카약 캐리어
TH โครงยึดเรือคายัคแบบติดตั้งบนหลังคา
MS Garrier tal-kayak immuntat fuq is-saqaf

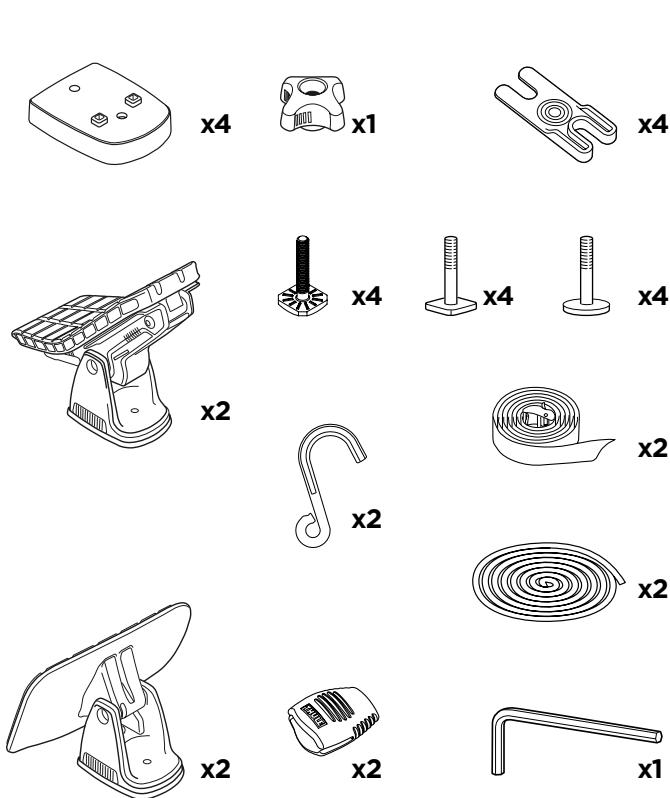
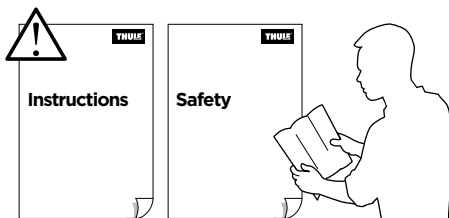

Included

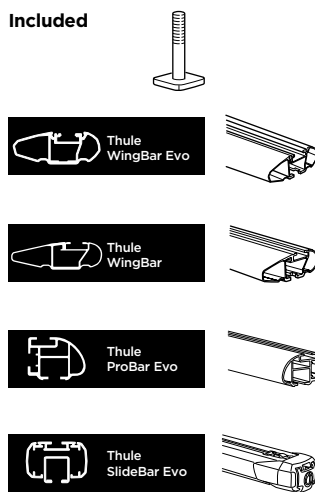

Optional

⊕ SquareBar Adapter 8897

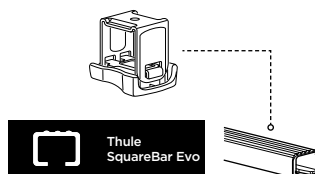

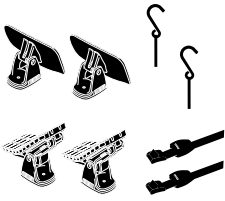

2.2 kg
4.8 lbs

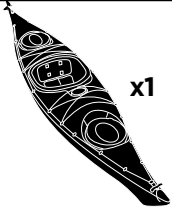

x1

Max 35 kg
77 lbs

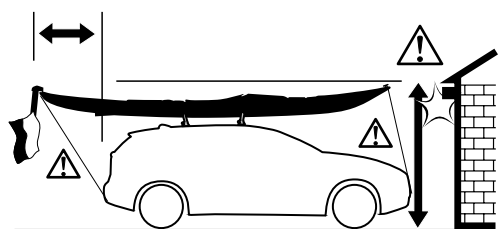
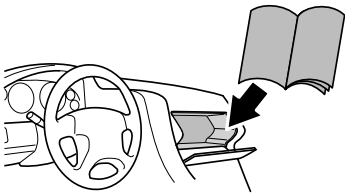
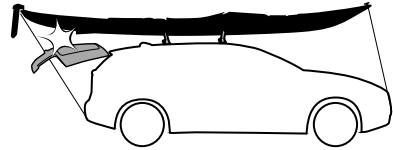
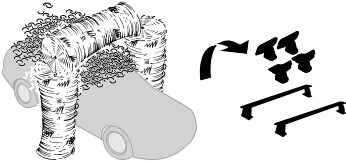
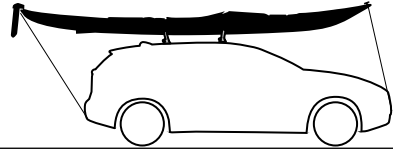

1.1



x1

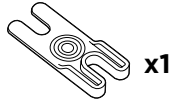

x1



x4

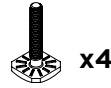

x4

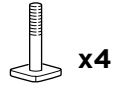

x4

A

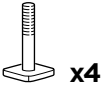

x4



x1

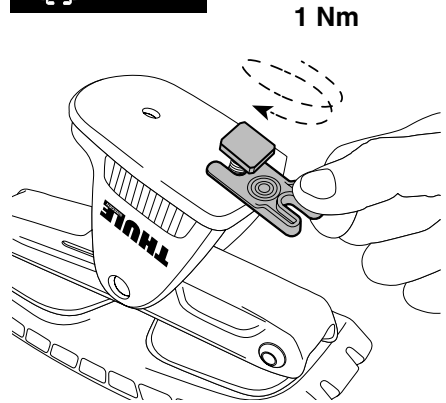
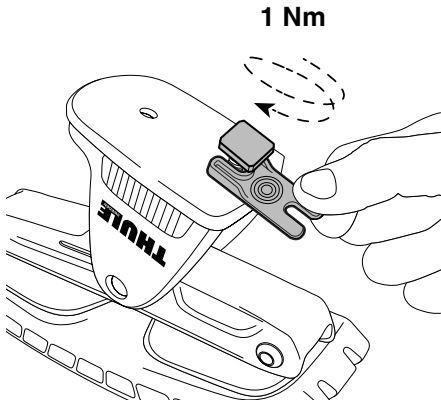
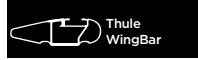

B

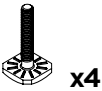

x4

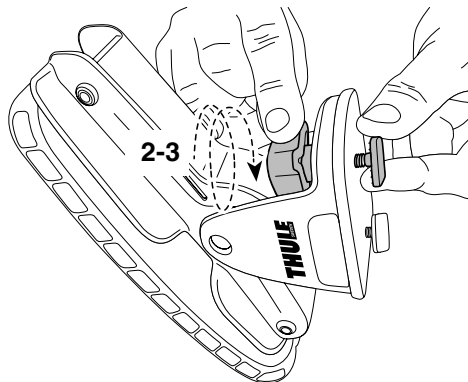

1.1

C

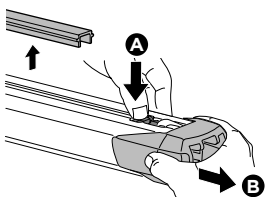
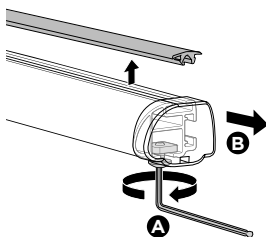
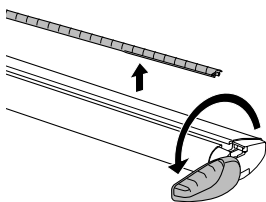
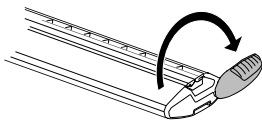

D

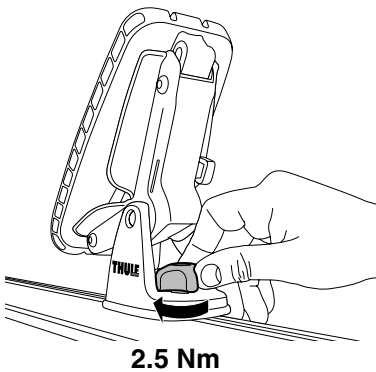
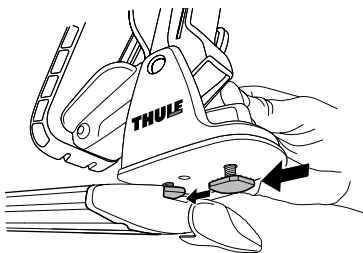
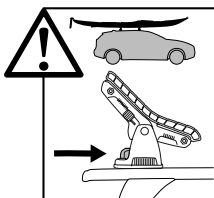
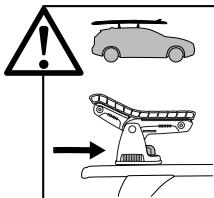

E

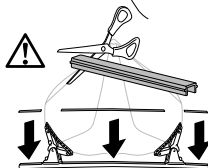
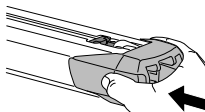
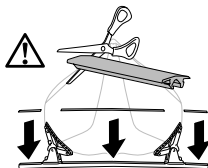
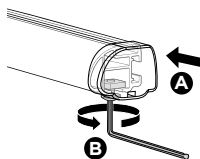
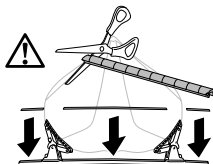
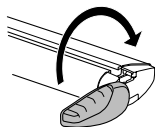
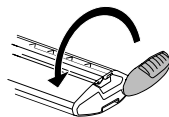

1.2



x1



x4

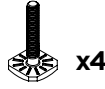

x4



x4

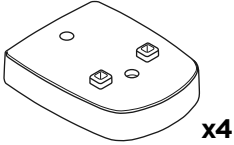

x4



Optional

SquareBar Adapter 8897

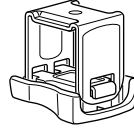

x4

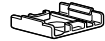

x4

A

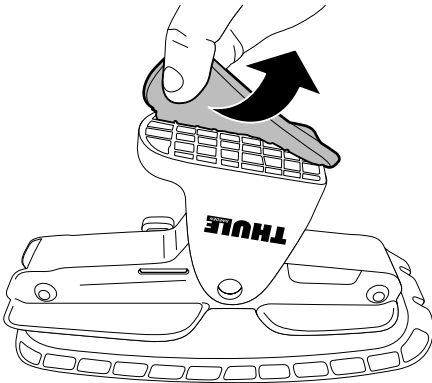

B

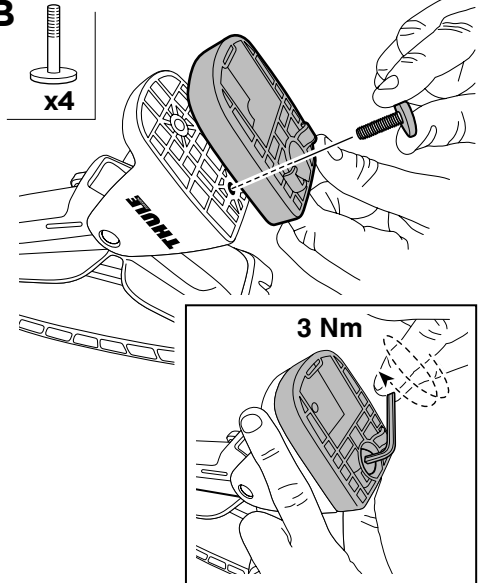

C



SquareBar Adapter 8897

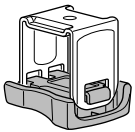

A

B

C

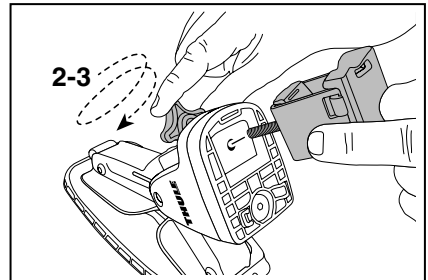
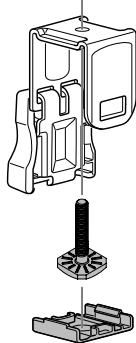

1.2

D

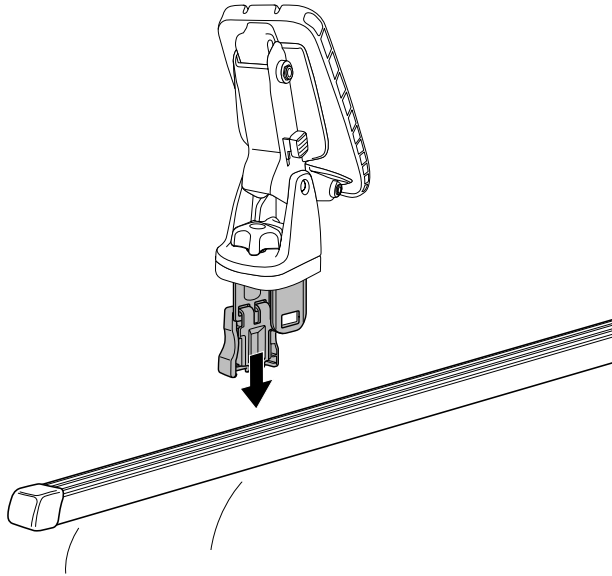

E

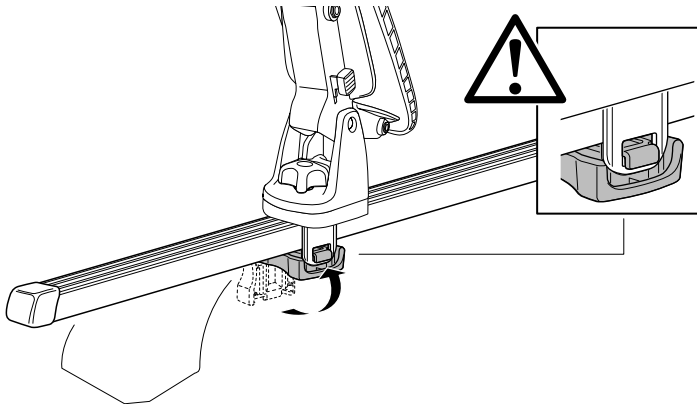

F

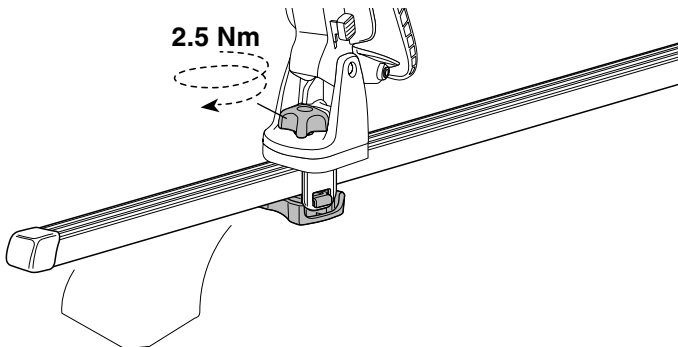

2

Min 610mm / 24 inch

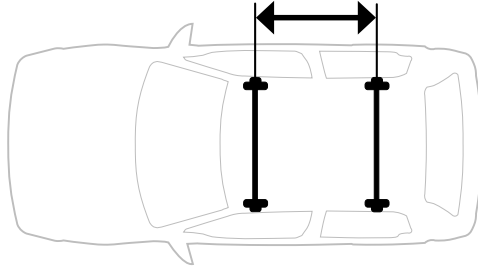

A

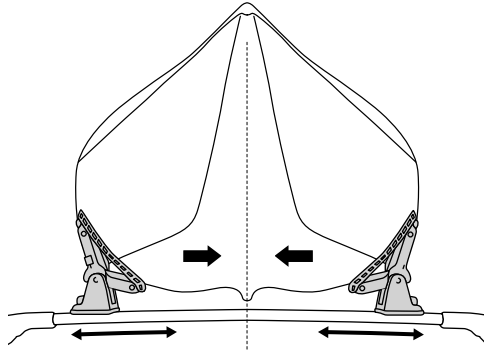
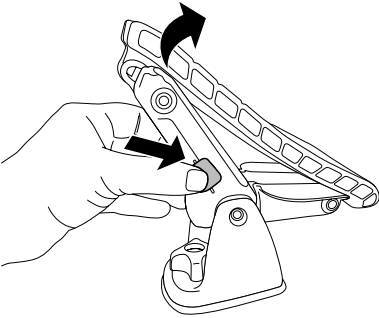
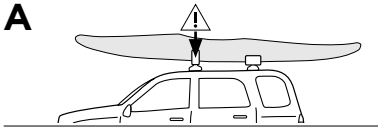

B

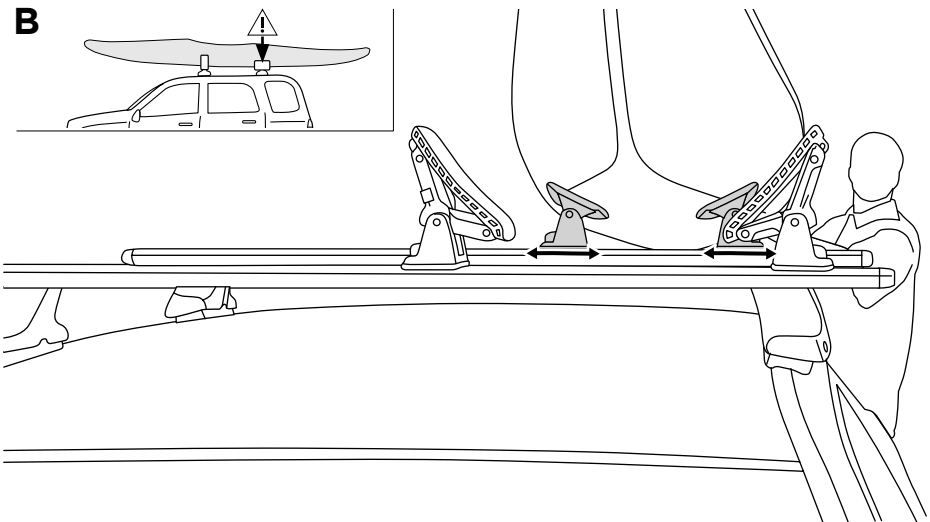
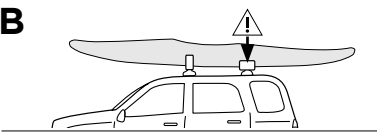

3

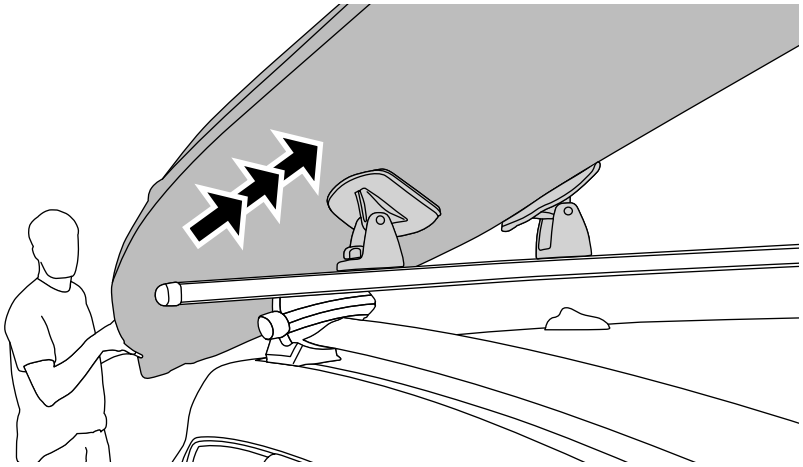

4

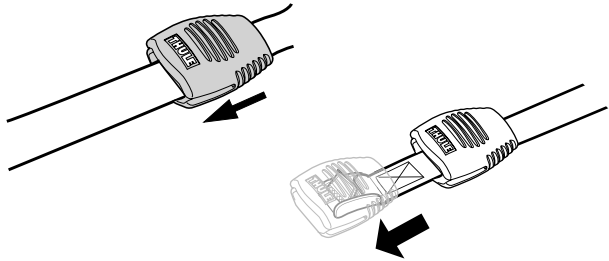
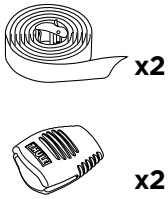

5

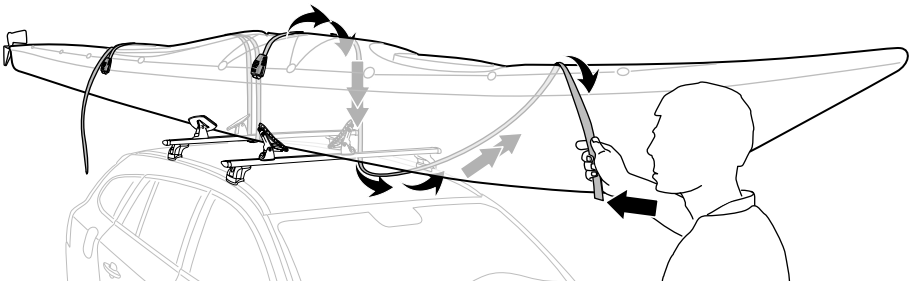
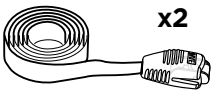

6

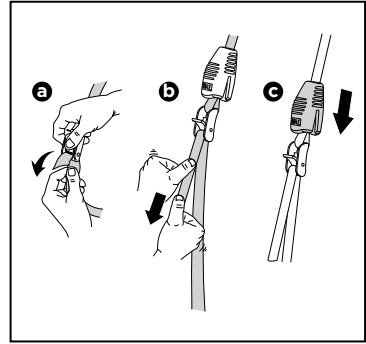
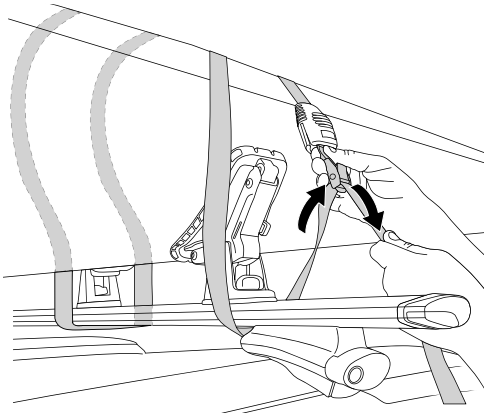

7

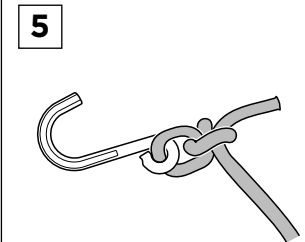
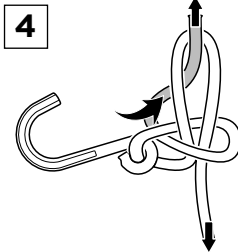
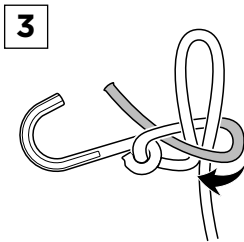
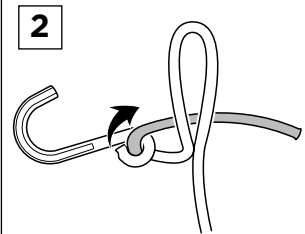
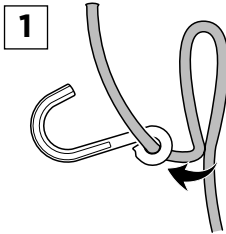
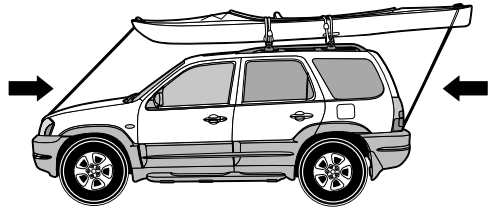
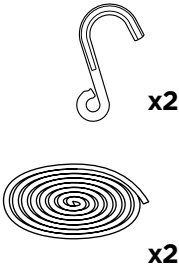

EN Accessories
FR Accessoires
ES Accesorios
DE Zubehör
NL Accessoires
PT Acessórios
IT Accessori
SV Tillbehör
DK Tilbehør

NO Tilbehør
FI Lisävarusteet
IS Aukabúnaður
ET Lisavarustus
LV Piederumi
LT Priedai
RU Аксессуары
UK Аксесуари
PL Akcesoria

CS Dopřloky
HU Tartozékok
RO Accesorii
SK Príslušenstvo
SL Dodatki
BG Принадлежности
HR Dodaci
EL Εξαρτήματα
TR Aksesuarlar

MT Accessorji

HE אביזרים
AR ملحقات

ZH (CN) 附件

ZH (TW) 配件

JA アクセサリー

KO 액세서리

TH อุปกรณ์เสริม

MS Aksesori

Thule SquareBar Adapter

8897



x2/x4

Thule Lockable Strap

841





x2



Thule JawGrip

856



x2

WW ▶  Thule Sweden AB, Borggatan 5, 335 73 Hillerstorp, SWEDEN
NA ▶  Thule Inc., 42 Silvermine Road, Seymour, Connecticut 06483, USA

 info@thule.com
 Phone: 800-238-2388

 www.thule.com

» PART OF THULE GROUP

© Thule Group 2021. All rights reserved.

506-7225-04