

# ➤ Instructions

## Thule Pacific 100, 200, 500, 600, 700, 780

631100, 631157, 631201, 631207, 631214, 631215, 631251, 631260,  
631262, 631550, 631554, 631600, 631608, 631650, 631652,  
631700, 631709, 631712, 631713, 631757, 631801, 631804,  
631808, 631809, 631811, 631812, 699700

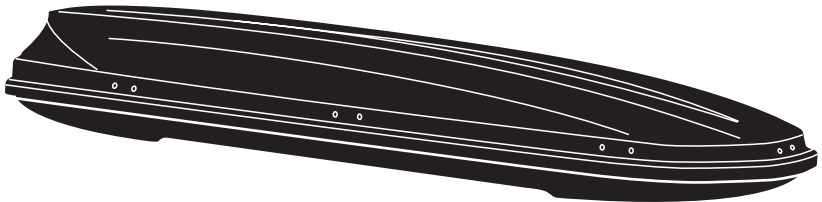

- EN** Roof box for roof-mounted racks  
**DE** Dachbox für Dachträger  
**FR** Coffre pour barres de toit  
**NL** Dakkoffer  
**IT** Box da tetto per portapacchi da installare sul tetto  
**ES** Cofre portaequipajes para barras de techo  
**PT** Caixa bagageira para barras de tejadilho  
**SV** Takbox för takmonterade räcken  
**DK** Tagboks til tagbøjler  
**NO** Takboks til takmonterte stativer  
**FI** Katolle asennettaviin telineisiin sopiva kuljetuslaatikko  
**ET** Katusela paigaldatav katuseboks  
**LV** Jumta kaste uz jumta uzstādāmiem bagāžniekiem  
**LT** Ant stogo tvirtinamų skersinių bagažinės  
**PL** Box dachowy na bagażnik montowany na dachu  
**RU** Грузовой бокс на крышу автомобиля  
**UK** Вантажний бокс для багажників для даху  
**BG** Кутия за багаж за релси, монтирани върху покрива

- CS** Střešní box pro montáž na střechu  
**SK** Strešný box na strešné nosiče  
**SL** Strešni kovček za strešne prtljažnike  
**HR/BIH** Krovna kutija za krovne nosače  
**RO** Portbagaj de acoperiș pentru cadru de bare montate pe acoperiș  
**HU** Tetőre szerelhető tetőbox  
**EL** Μπαγκαζιέρα οροφής για μπάρρες οροφής  
**TR** Araç üstüne bağlanan raflar için tavan kutusu  
**HE** תא חפצים לגג הרכב  
**AR** صندوق سقف للحوامل المثبتة على السقف

- ZH** 用于车顶架的车顶箱  
**JA** ルーフマウント型ラック用ルーフボックス  
**KO** 루프 장착 랙 루프 박스  
**TH** กล่องบนหลังคาสำหรับแร็คหลังคา

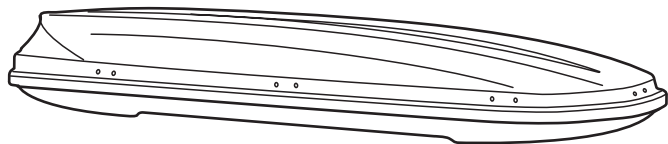
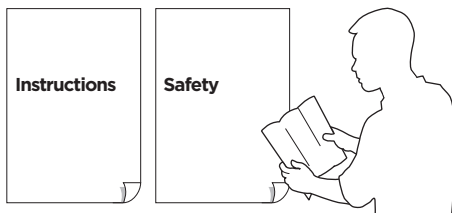

x1

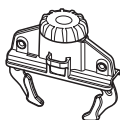

x4

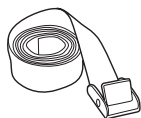

x2



x2



x1

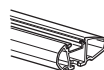

Thule WingBar Evo

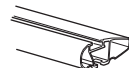

Thule WingBar/  
Thule AeroBlade

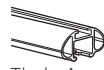

Thule AeroBar

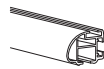

Thule ProBar Evo



Thule SlideBar Evo



Thule Squarebar Evo

**i**

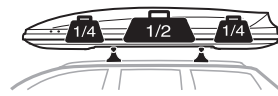
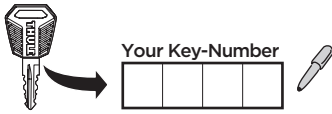

**Max  
50 kg**

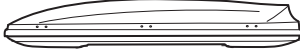

	Weight	Volume
Pacific 100	10kg	330 litre
Pacific 200	13 kg	410 litre
Pacific 500	13 kg	290 litre
Pacific 600	12 kg	310 litre
Pacific 700	15 kg	420 litre
Pacific 780	15 kg	420 litre

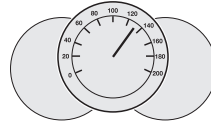

**Max  
130 km/h**

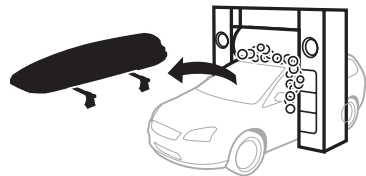
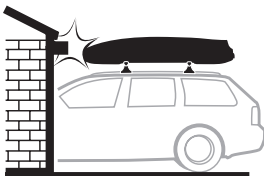
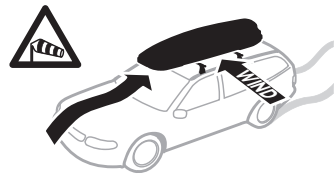
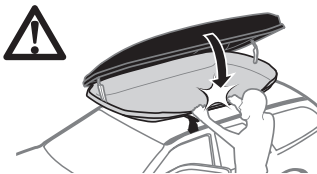
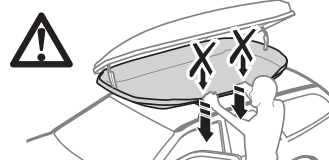
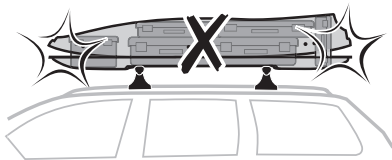

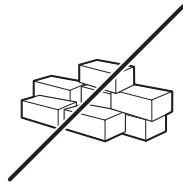
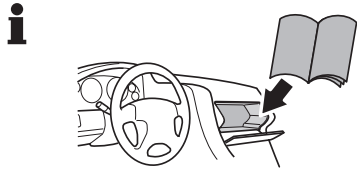
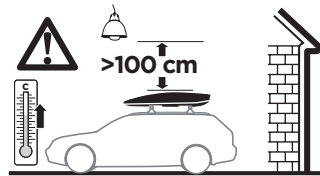
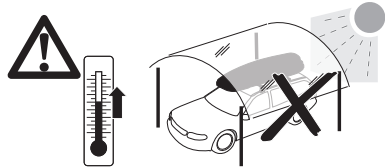
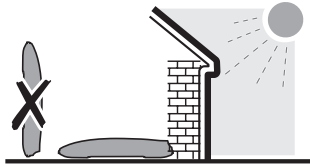

**i**

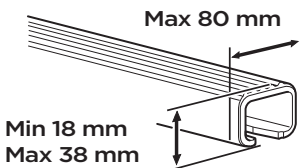
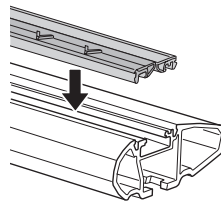
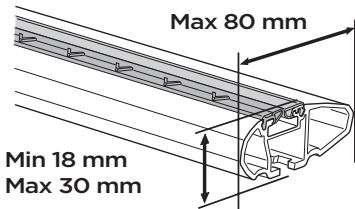

Thule T-track Adapter

**696400**

**697400**

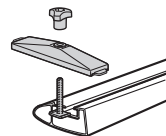



		D Min	D Max	W in	W out	H	L	R Min
<i>Pacific 100</i>	mm	515	925	810	906	359	1402	941
<i>Pacific 200</i>	mm	545	955	726	825	416	1770	1148
<i>Pacific 500</i>	mm	545	955	452	537	336	2245	1388
<i>Pacific 600</i>	mm	545	955	544	638	359	1914	1182
<i>Pacific 700</i>	mm	545	955	604	698	370	2330	1438
<i>Pacific 780</i>	mm	545	955	687	780	400	1968	1251

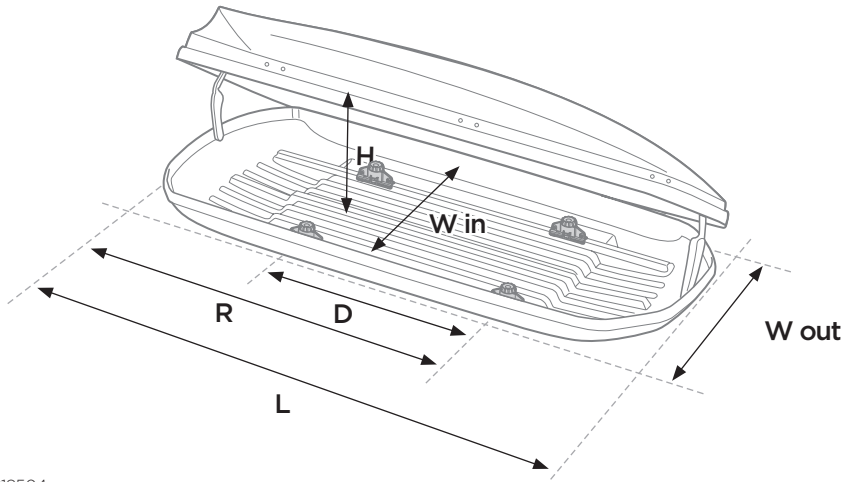
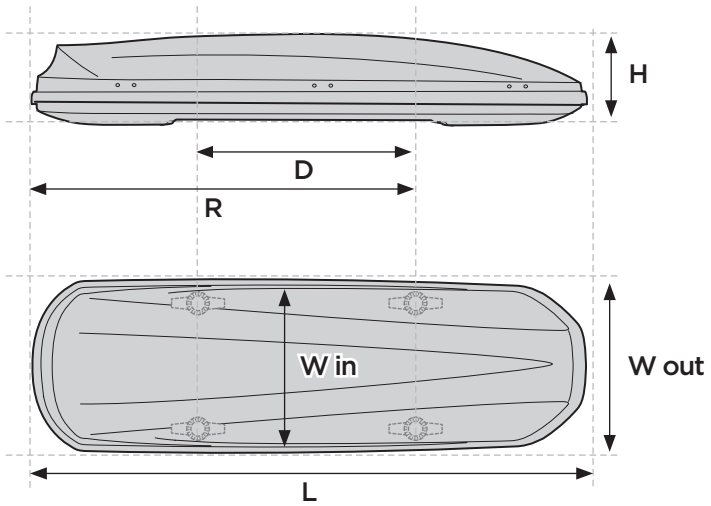

1

**i**

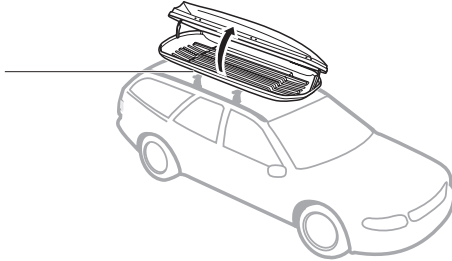
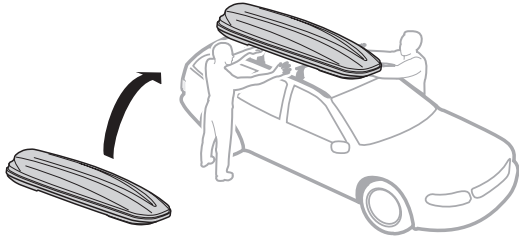

2

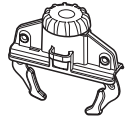

x4

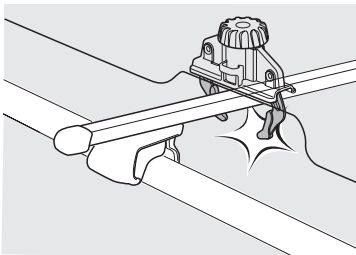
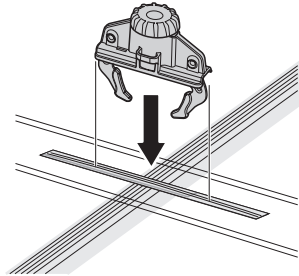
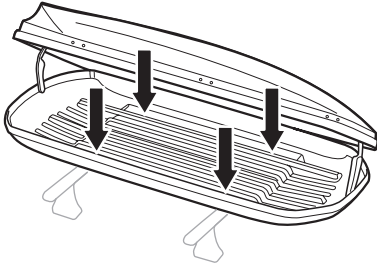

3

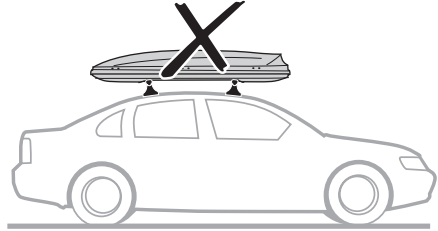
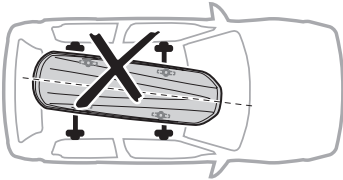
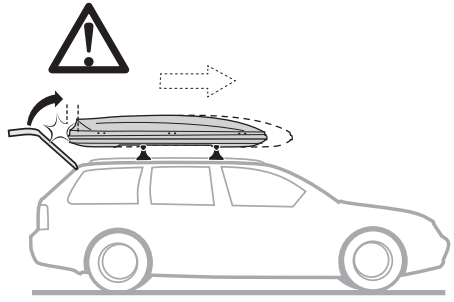
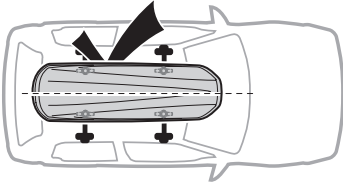

4

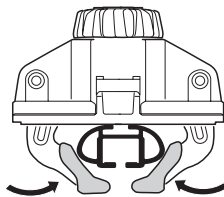
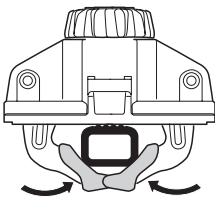
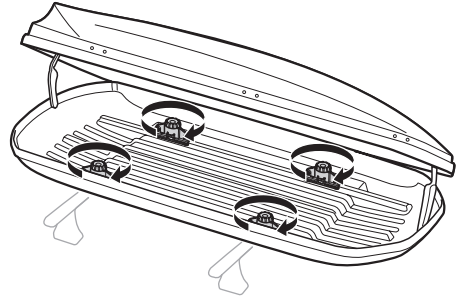
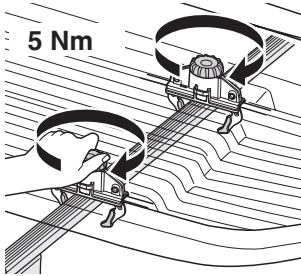

ok

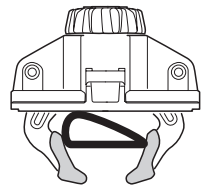

Not ok

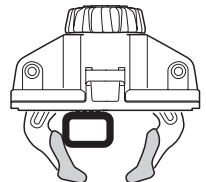

5

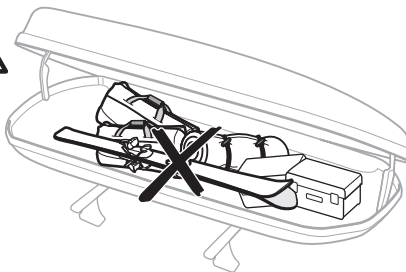
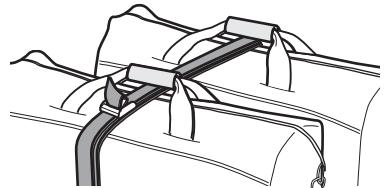
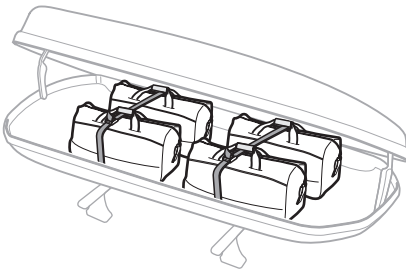
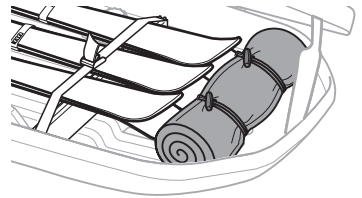
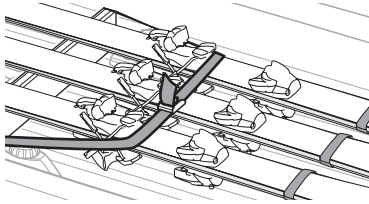
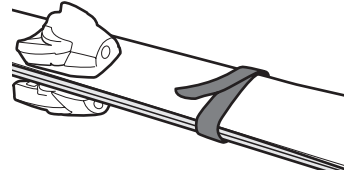
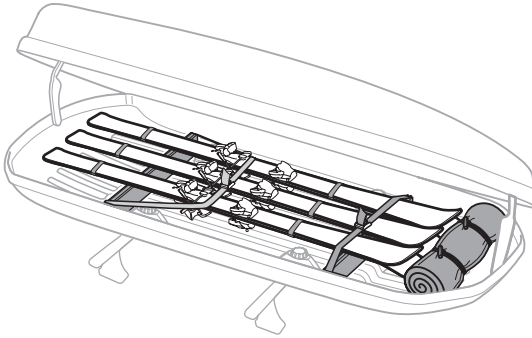
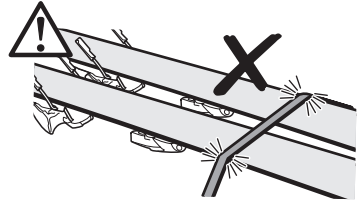
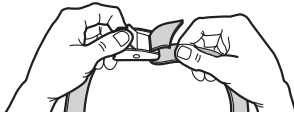



6

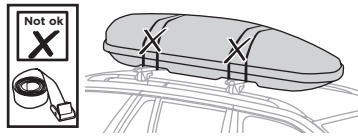
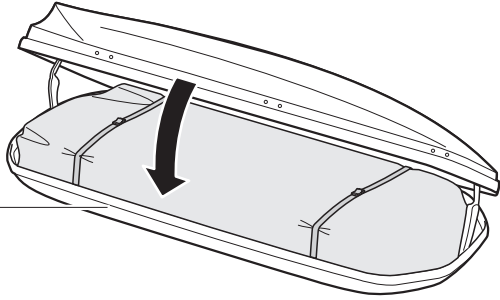
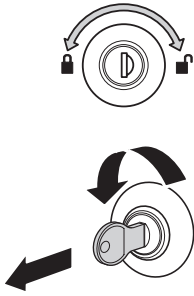

7

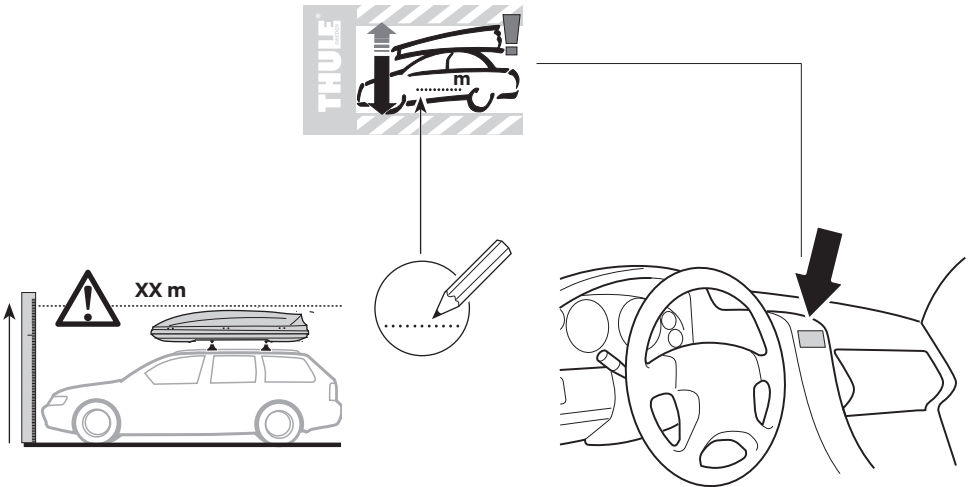

<b>EN</b> Accessories	<b>DK</b> Tilbehør	<b>UK</b> Аксессуары	<b>EL</b> Εξαρτήματα
<b>DE</b> Zubehör	<b>NE</b> Tilbehør	<b>BG</b> Принадлежности	<b>TR</b> Aksesuarlar
<b>FR</b> Accessoires	<b>FI</b> Lisävarusteet	<b>CS</b> Doplňky	<b>AR</b> الملحقات
<b>NL</b> Accessoires	<b>ET</b> Lisavarustus	<b>SK</b> Príslušenstvo	<b>HE</b> מוצרים
<b>IT</b> Accessori	<b>LV</b> Piederumi	<b>SL</b> Dodatki	<b>ZH</b> 附件
<b>ES</b> Accesorios	<b>LT</b> Priedai	<b>HR/BIH</b> Dodaci	<b>JA</b> アクセサリー
<b>PT</b> Acessórios	<b>PL</b> Akcesoria	<b>RO</b> Accesorii	<b>KO</b> 액세서리
<b>SV</b> Tillbehör	<b>RU</b> Аксессуары	<b>HU</b> Tartozékok	<b>TH</b> อุปกรณ์เสริม

## Thule T-track Adapter

**696400** → 24x30 mm

**697400** → 20x27 mm

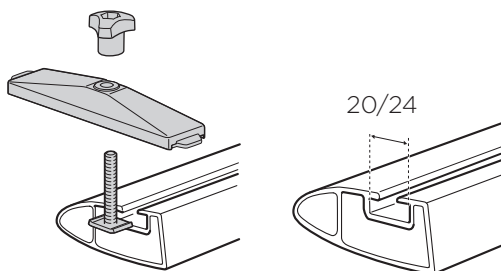

## Thule MultiLift

**572004**

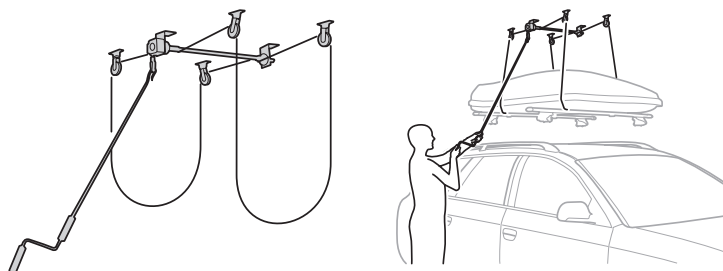

## Thule Box Light

**695100**

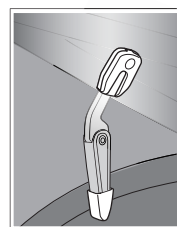
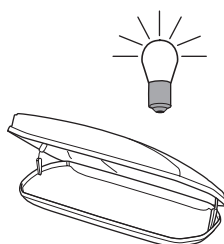
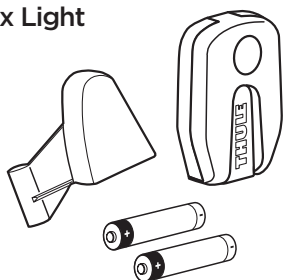

## Thule Box Ski Carrier Adapter

**694500** → Pacific 500

**694600** → Pacific 600

**694700** → Pacific 700

**694800** → Pacific 200, 780

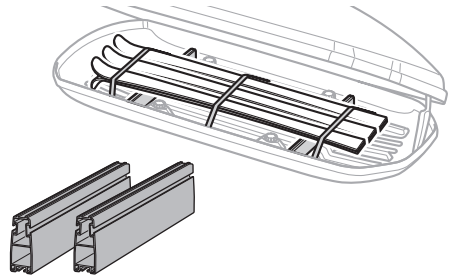

---

## Thule Box Lid Cover

**698100** → Pacific 100, 200, 780

**698200** → Pacific 500, 600, 700

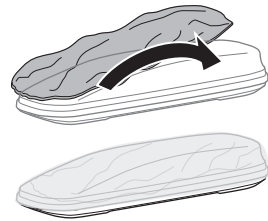

# Thule One-Key System

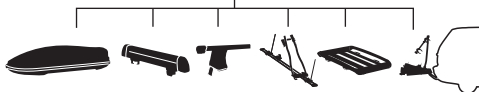

**450400**  (x4)

**450600**  (x6)

**450800**  (x8)

**451200**  (x12)

**451600**  (x16)

**1**

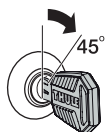

**2**



**3**

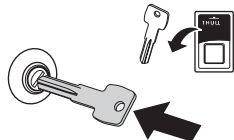

**4**

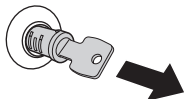

**5**



**6**

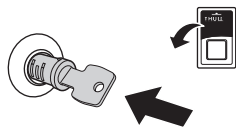

**7**

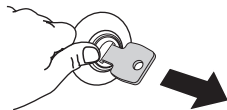

**8**

