

# ➤ Instructions

## Thule Motion XT

6292 6295 6296 6297 6298 6299

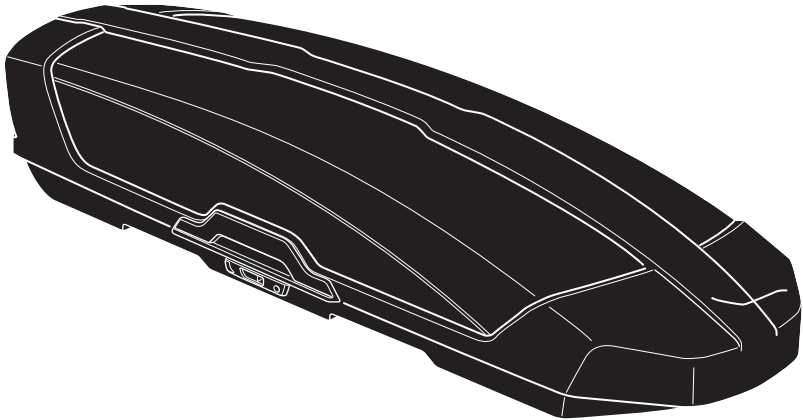

- EN** Roof box for roof-mounted racks  
**DE** Dachbox für Dachträger  
**FR** Coffre pour barres de toit  
**NL** Dakkoffer  
**IT** Box da tetto per portapacchi da installare sul tetto  
**ES** Cofre portaequipajes para barras de techo  
**PT** Caixa bagageira para barras de tejadilho  
**SV** Takbox för takmonterade räckor  
**DK** Tagboks til tagbjælter  
**NO** Takboks til takmonterte stativer  
**FI** Katolle asennettaviin telineisiin sopiva kuljetuslaatikko  
**ET** Katusele paigaldatav katuseboks  
**LV** Jumta kaste uz jumta uzstādāmiem bagāžniekiem  
**LT** Ant stogo tvirtinamų skersinių bagažinės  
**PL** Box dachowy na bagażnik montowany na dachu  
**RU** Грузовой бокс на крышу автомобиля  
**UK** Вантажний бокс для багажників для даху  
**BG** Кутия за багаж за релси, монтирани върху покрива  
**CS** Střešní box pro montáž na střechu  
**SK** Strešný box na strešné nosiče
- SL** Strešni kovček za strešne prtljažnike  
**HR/BIH** Krovna kutija za krovne nosače  
**RO** Portbagaj de acoperiș pentru cadru de bare montate pe acoperiș  
**HU** Tetőre szerelhető tetőbox  
**EL** Μπαγκάζιέρα οροφής για μπάρρες οροφής  
**TR** Araç üstüne bağlanan raflar için tavan kutusu  
**HE** תא חפצים ללגג הרכב  
**AR** صندوق سقف للحوامل المثبتة على السقف  
**ZH** 用于车顶架的车顶箱  
**JA** ルーフマウント型ラック用ルーフボックス  
**KO** 루프 장착 랙 루프 박스  
**TH** กล่องบนหลังคาสำหรับแร็คหลังคา



**CITY CRASH**  
Complies with ISO norm

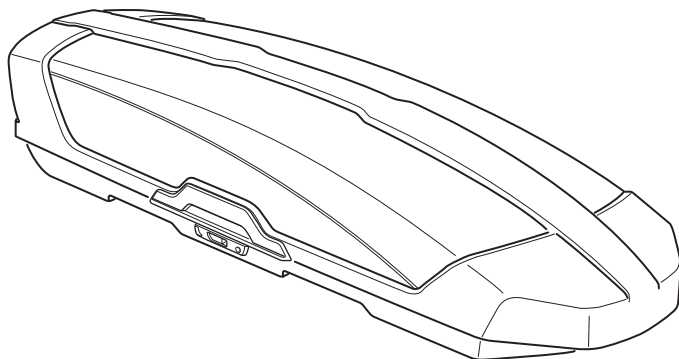
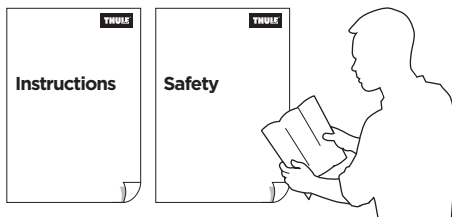

x1

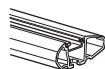

Thule WingBar Evo

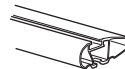

Thule WingBar

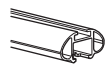

Thule AeroBar



Thule SlideBar



Thule Squarebar



x1



x3



x2

**i**

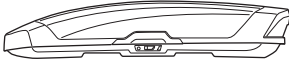
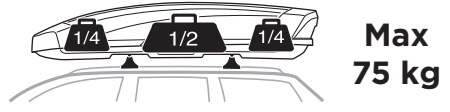

Sport	16 kg
M	17,5 kg
L	20 kg
XL	23,5 kg
XXL	25,5 kg
Alpine	25,5 kg

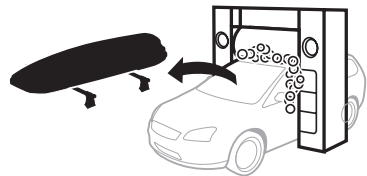
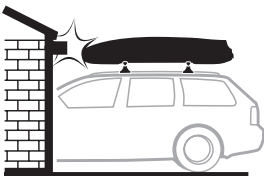
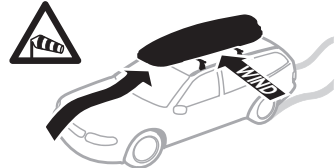
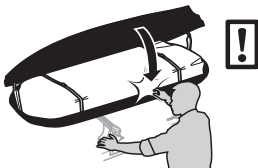
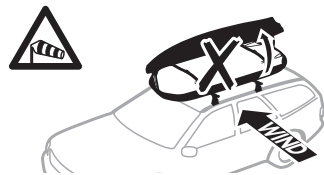
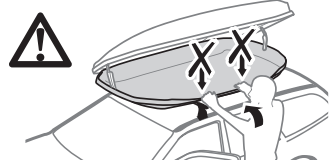
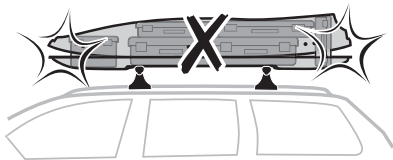
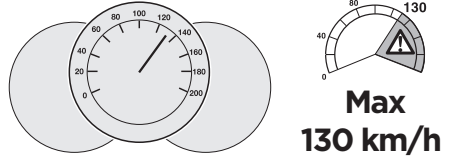

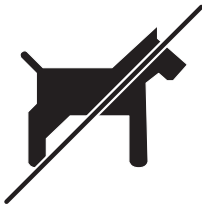
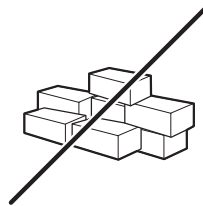
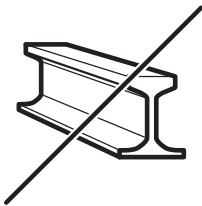
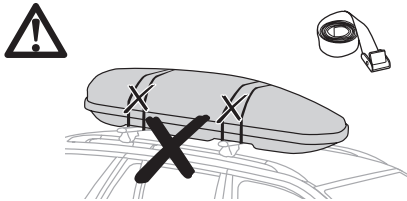
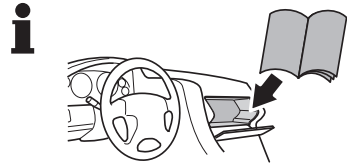
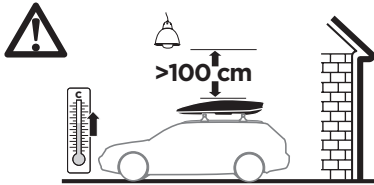
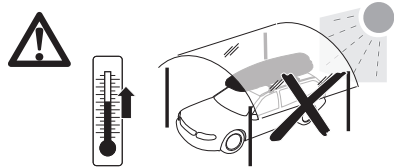
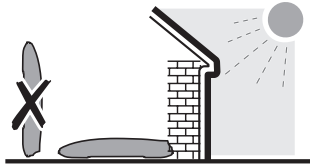



# Thule T-track Adapter

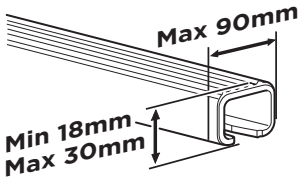

696600

697600

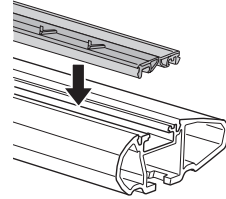
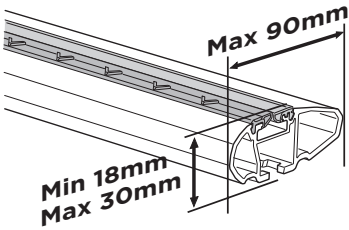
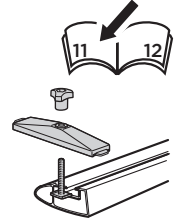

	D Min*	D Max*	W in*	W out*	H*	R Min*
M	560	930	755	865	460	1198
Sport	560	930	565	675	430	1250
L	560	930	785	895	440	1290
XL	560	930	805	915	440	1347
XXL	560	930	840	950	470	1440
Alpine	560	930	840	950	350	1417

\*mm

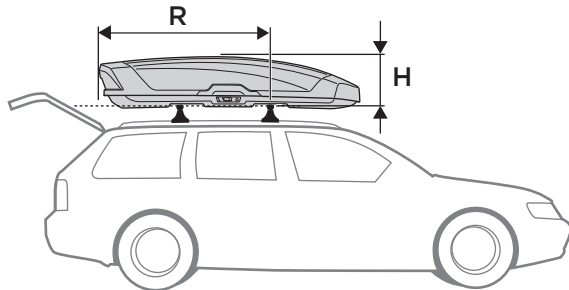
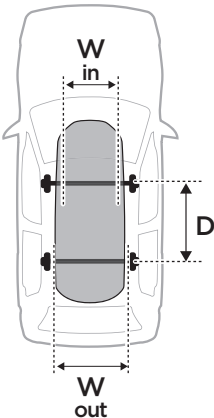

1

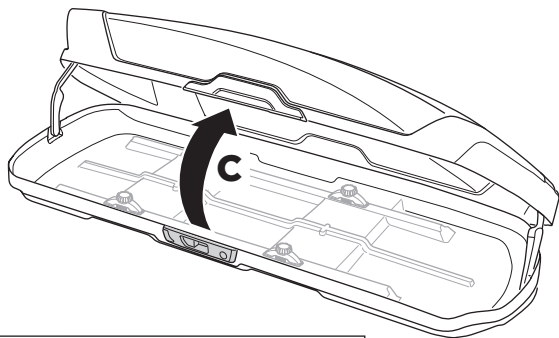
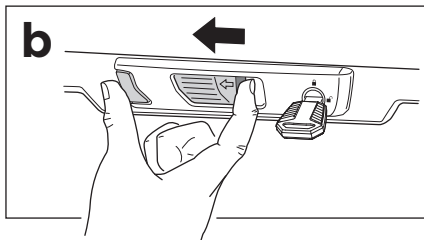
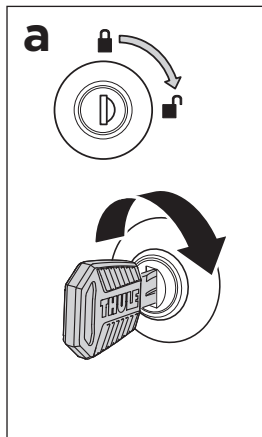

2

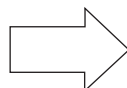
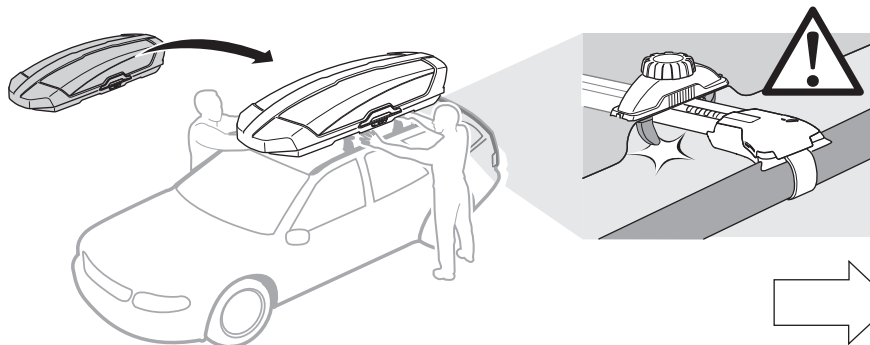
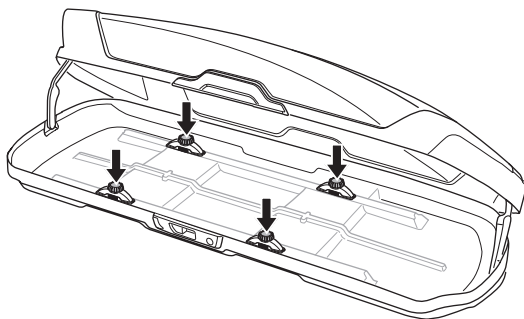
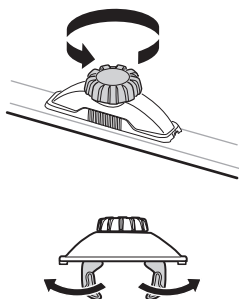

3

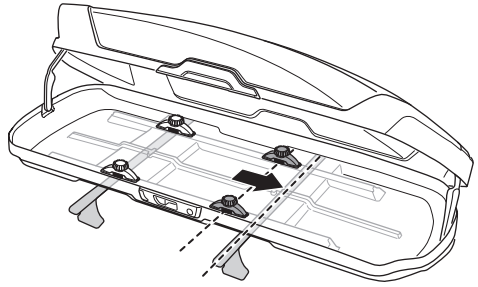
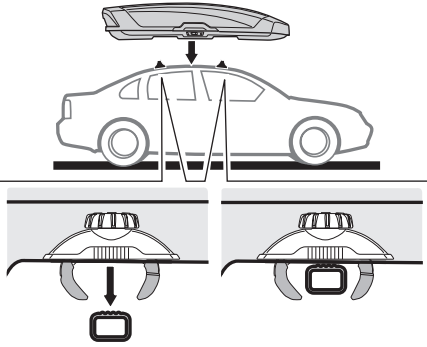
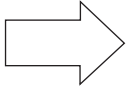

4

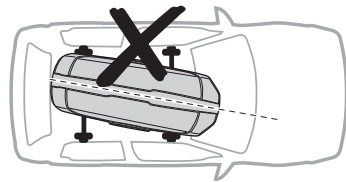
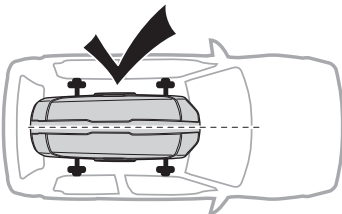
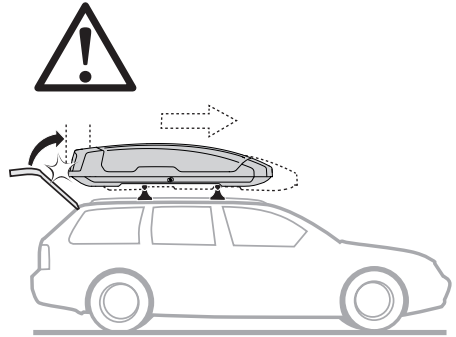
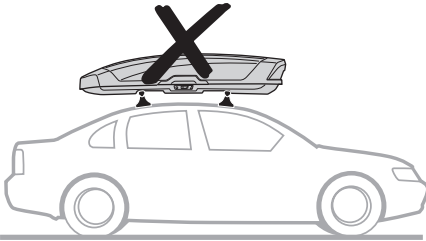

5

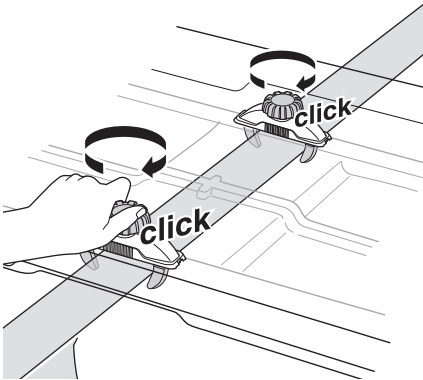
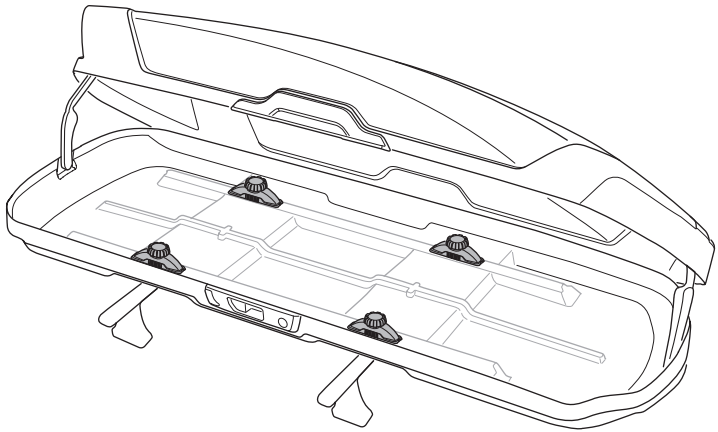

**i**

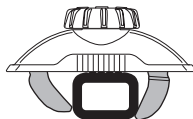
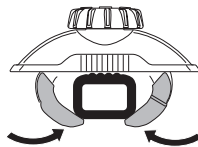
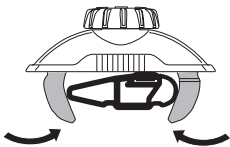
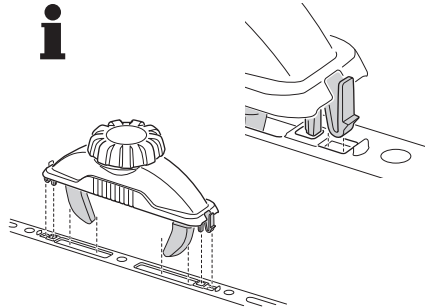



6



x 3

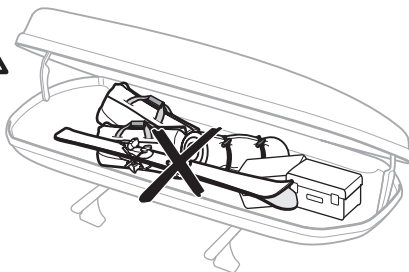
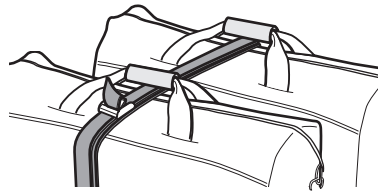
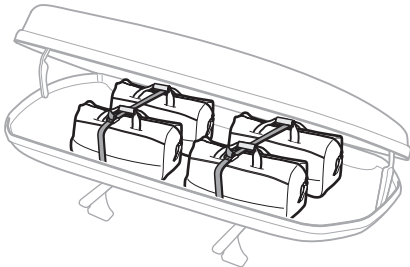
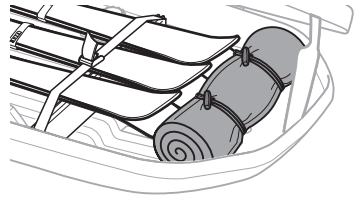
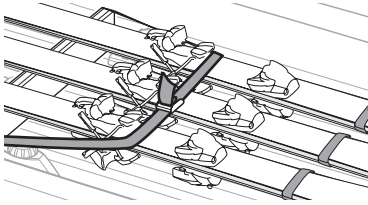
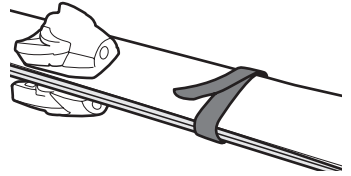
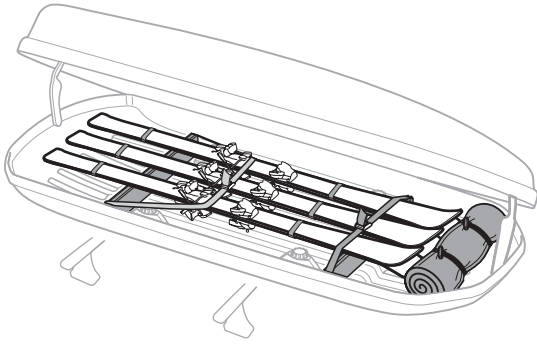
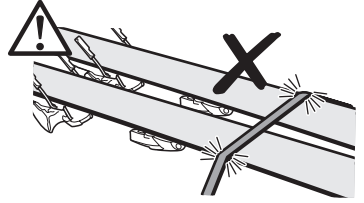
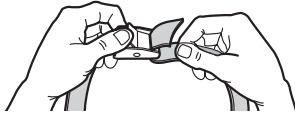

7

a

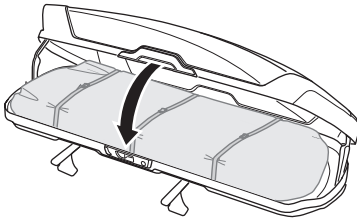

b

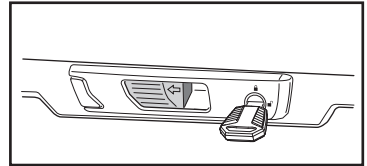
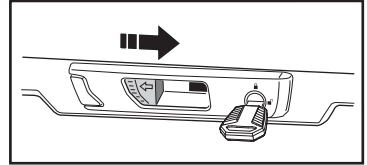
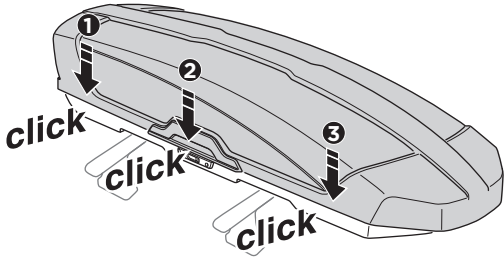

c

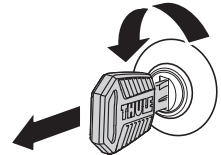
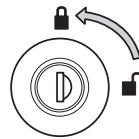
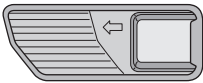
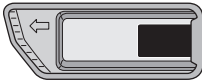

8

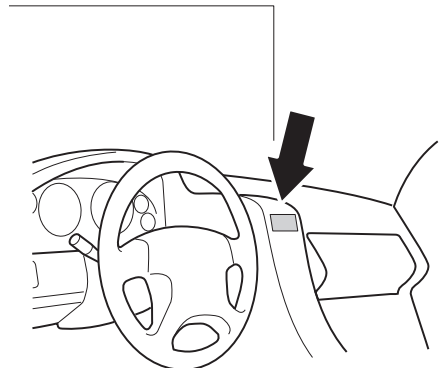
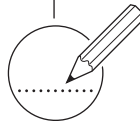
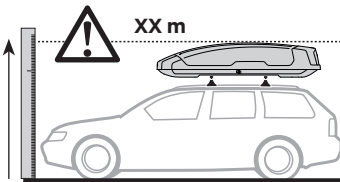
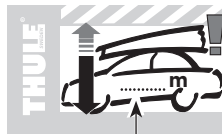

## Thule T-track Adapter

**696600** → 24x30 mm

**697600** → 20x27 mm

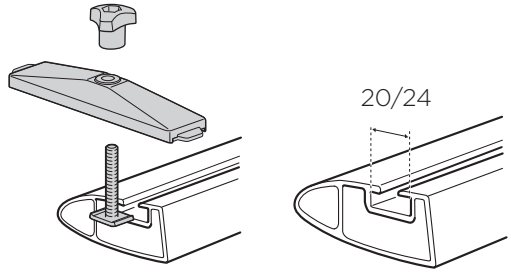

## Thule MultiLift

**572004**

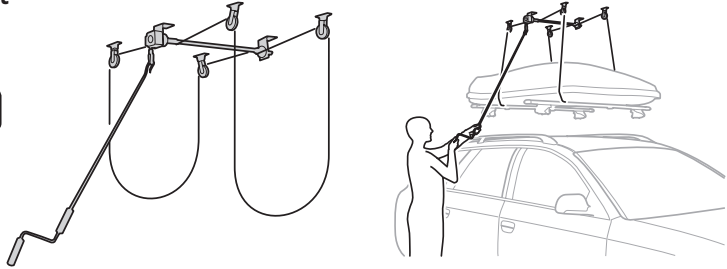

## Thule Box Ski Carrier Adapter

**694600** → Sport

**694800** → M/L

**694900** → XL/XXL/Alpine

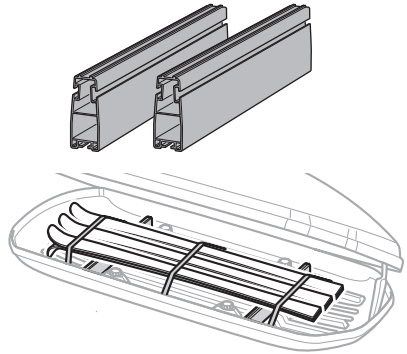

## Thule Box Lid Cover

**698100** → S/M/L

**698200** → Sport



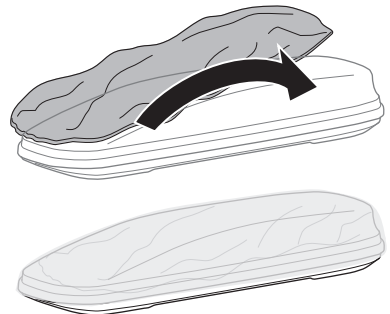

**698400** → XL/XXL/Alpine

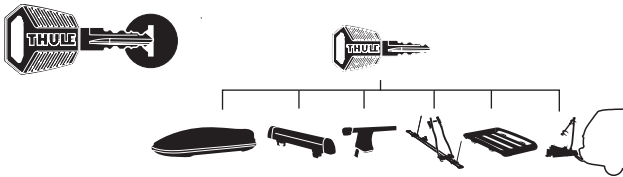

<b>EN</b> Accessories	<b>DK</b> Tilbehør	<b>UK</b> Аксессуары	<b>EL</b> Εξαρτήματα
<b>DE</b> Zubehör	<b>NE</b> Tilbehør	<b>BG</b> Принадлежности	<b>TR</b> Aksesuarlar
<b>FR</b> Accessoires	<b>FI</b> Lisävarusteet	<b>CS</b> Doplòky	<b>AR</b> الملحقات
<b>NL</b> Accessoires	<b>ET</b> Lisavarustus	<b>SK</b> Príslušenstvo	<b>HE</b> אביזרים
<b>IT</b> Accessori	<b>LV</b> Piederumi	<b>SL</b> Dodatki	<b>ZH</b> 附件
<b>ES</b> Accesorios	<b>LT</b> Priedai	<b>HR/BiH</b> Dodaci	<b>JA</b> アクセサリー
<b>PT</b> Acessórios	<b>PL</b> Akcesoria	<b>RO</b> Accesorii	<b>KO</b> 액세서리
<b>SV</b> Tillbehör	<b>RU</b> Аксессуары	<b>HU</b> Tartozékok	<b>TH</b> อุปกรณ์เสริม

## Thule One-Key System



- 450400**  (x4)
- 450600**  (x6)
- 450800**  (x8)
- 451200**  (x12)
- 451600**  (x16)

