

➤ Instructions

Thule Motion XT

6292 6295 6296 6297 6298 6299

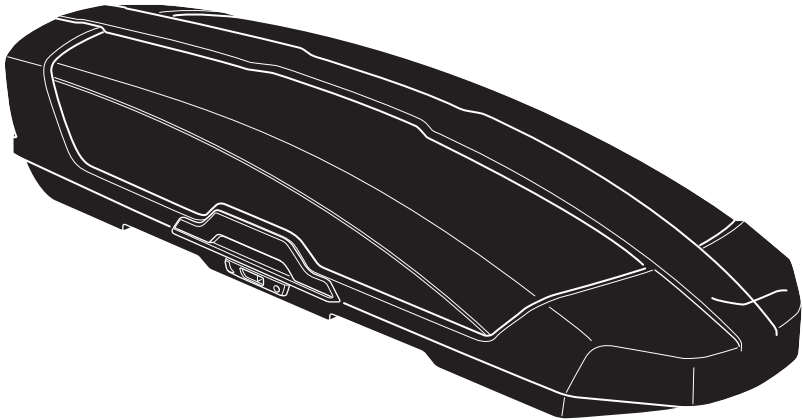

- EN** Roof box for roof-mounted racks
DE Dachbox für Dachträger
FR Coffre pour barres de toit
NL Dakkoffer
IT Box da tetto per portapacchi da installare sul tetto
ES Cofre portaequipajes para barras de techo
PT Caixa bagageira para barras de tejadilho
SV Takbox för takmonterade räckor
DK Tagboks til tagbjælter
NO Takboks til takmonterte stativer
FI Katolle asennettaviin telineisiin sopiva kuljetuslaatikko
ET Katusele paigaldatav katuseboks
LV Jumta kaste uz jumta uzstādāmiem bagāžniekiem
LT Ant stogo tvirtinamų skersinių bagažinės
PL Box dachowy na bagażnik montowany na dachu
RU Грузовой бокс на крышу автомобиля
UK Вантажний бокс для багажників для даху
BG Кутия за багаж за релси, монтирани върху покрива
CS Střešní box pro montáž na střeche
SK Strešný box na strešné nosiče
- SL** Strešni kovček za strešne prtljažnike
HR/BIH Krovna kutija za krovne nosače
RO Portbagaj de acoperiș pentru cadru de bare montate pe acoperiș
HU Tetőre szerelhető tetőbox
EL Μπαγκάζιέρα οροφής για μπάρες οροφής
TR Araç üstüne bağlanan raflar için tavan kutusu
- HE** תא חפצים ללגג הרכב
AR صندوق سقف للحوامل المثبتة على السقف
- ZH** 用于车顶架的车顶箱
JA ルーフマウント型ラック用ルーフボックス
KO 루프 장착 랙 루프 박스
TH กล่องบนหลังคาสำหรับแร็คหลังคา



CITY CRASH
Complies with ISO norm

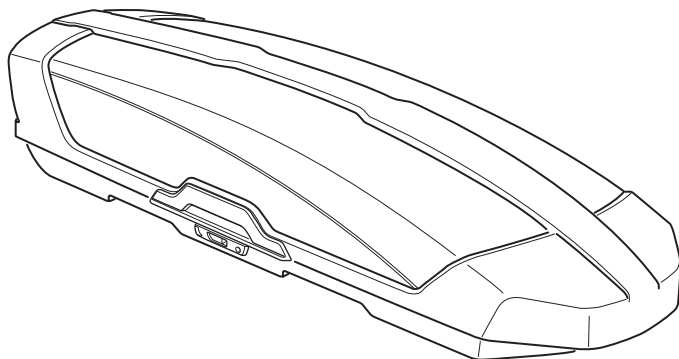
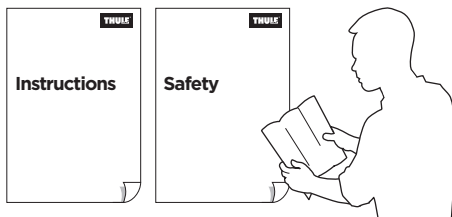

x1



x1



x3



x2

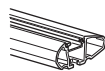

Thule WingBar Evo

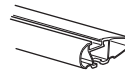

Thule WingBar

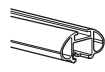

Thule AeroBar



Thule SlideBar

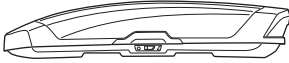
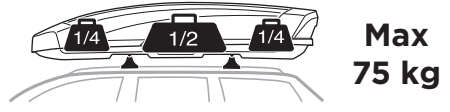

Thule Squarebar

i

Sport	16 kg
M	17,5 kg
L	20 kg
XL	23,5 kg
XXL	25,5 kg
Alpine	25,5 kg

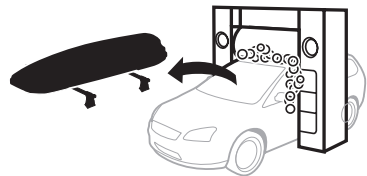
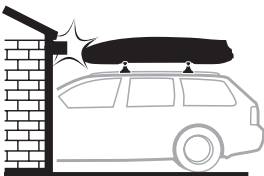
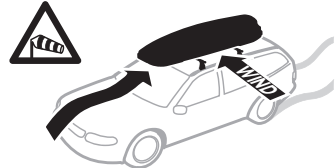
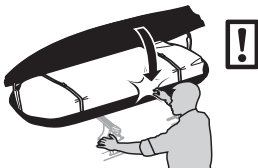
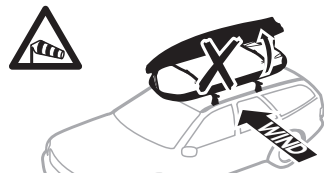
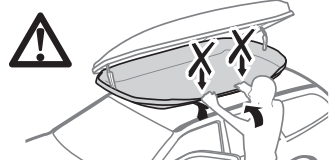
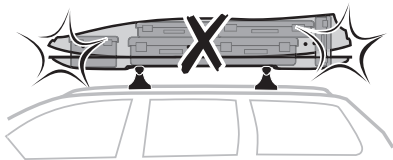
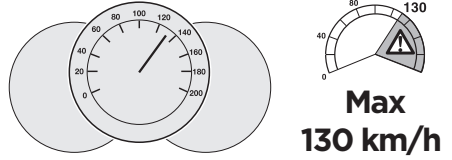

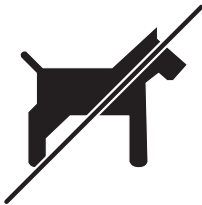
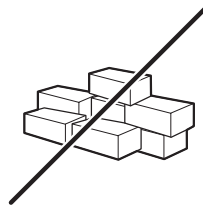
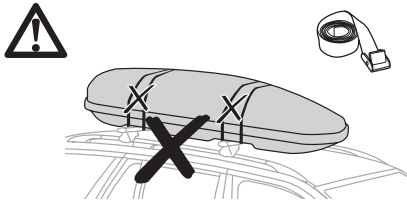
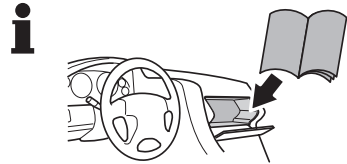
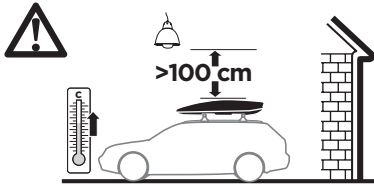
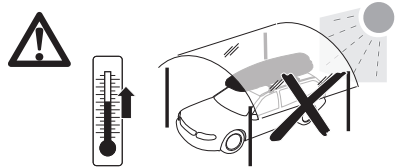
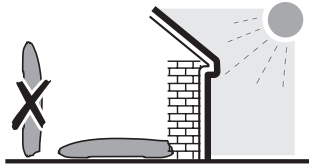



Thule T-track Adapter

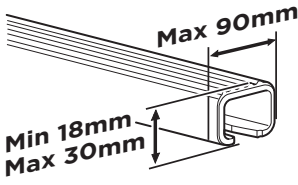

696600

697600

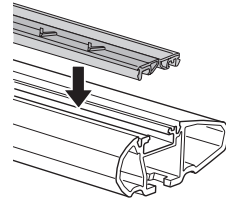
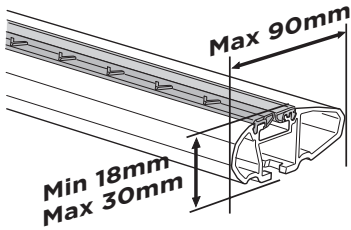
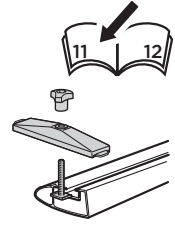

	D Min*	D Max*	W in*	W out*	H*	R Min*
M	560	930	755	865	460	1198
Sport	560	930	565	675	430	1250
L	560	930	785	895	440	1290
XL	560	930	805	915	440	1347
XXL	560	930	840	950	470	1440
Alpine	560	930	840	950	350	1417

*mm

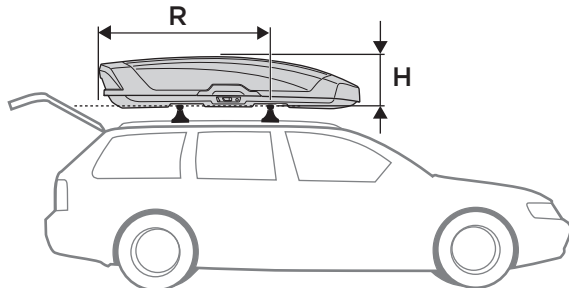
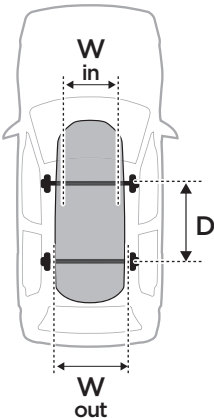

1

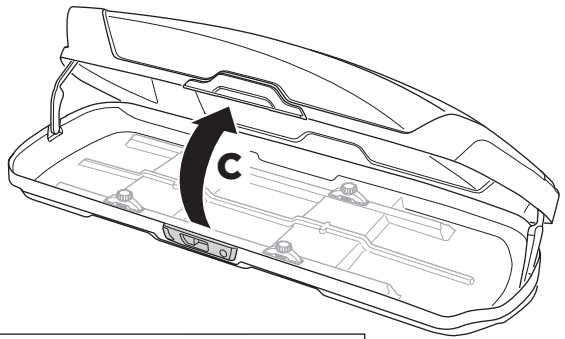
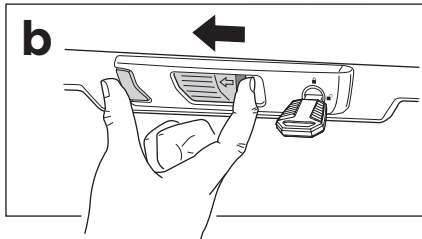
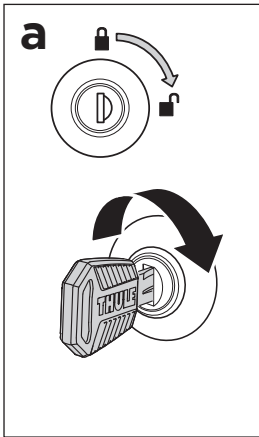

2

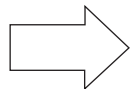
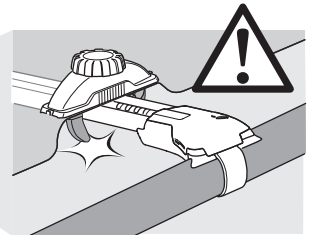
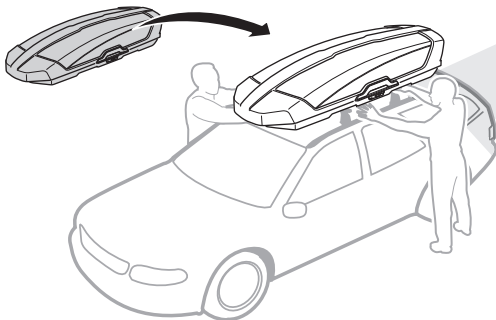
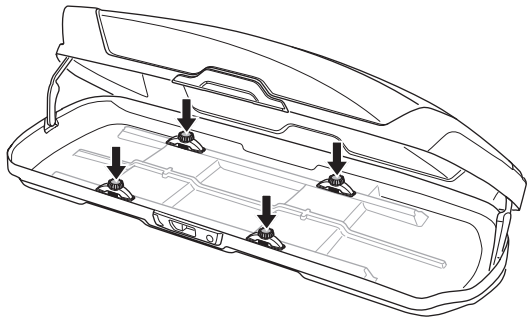

3

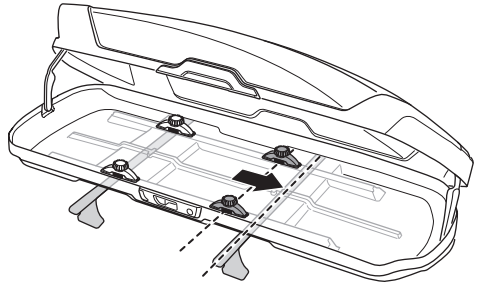
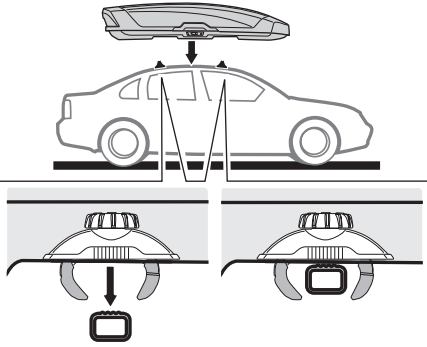
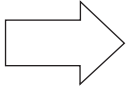

4

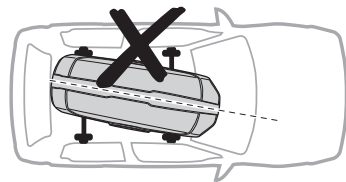
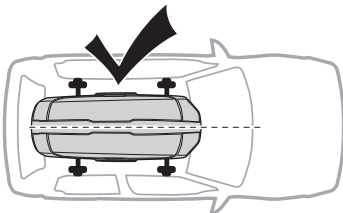
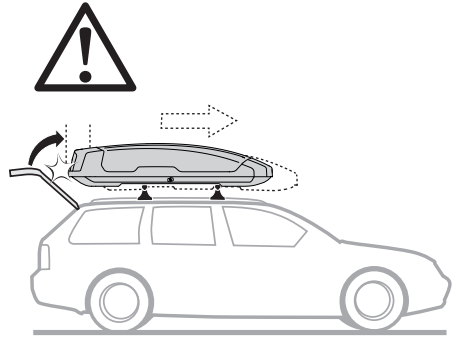
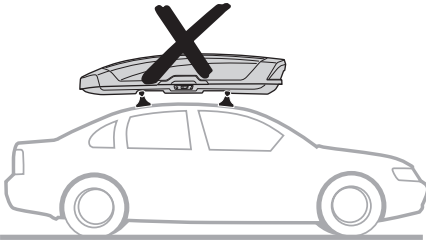

5

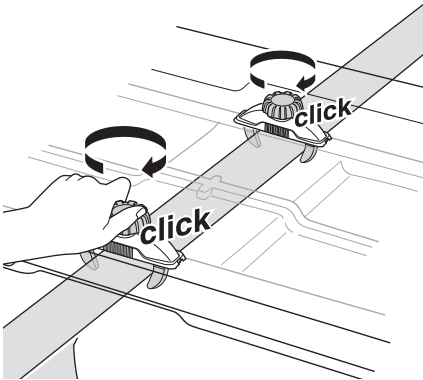
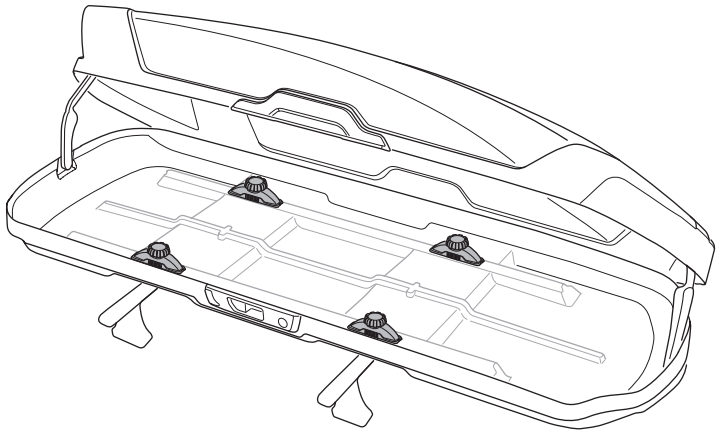

i

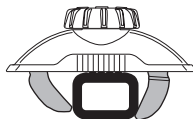
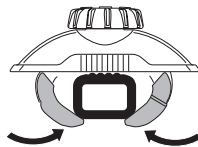
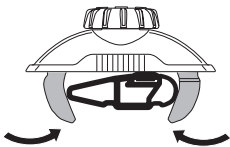
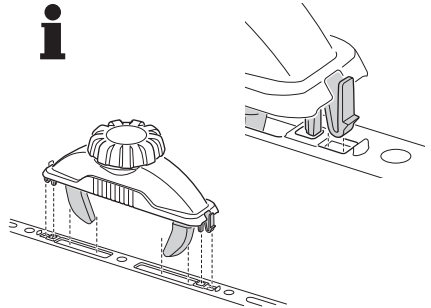

6



x 3

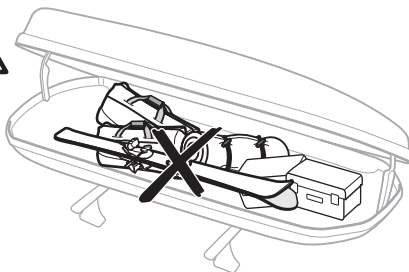
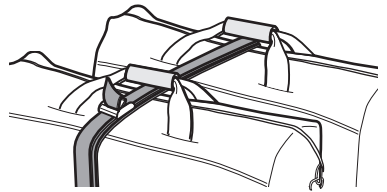
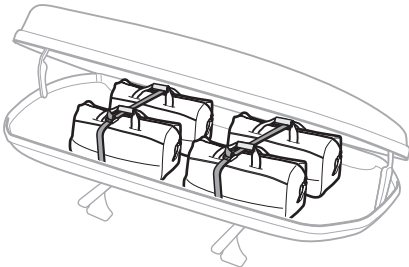
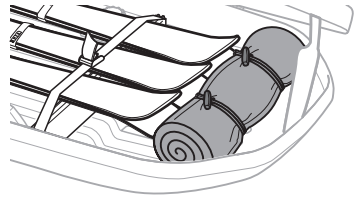
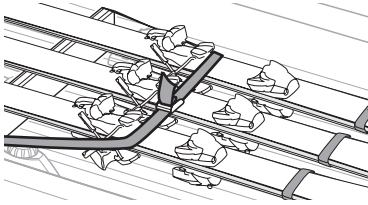
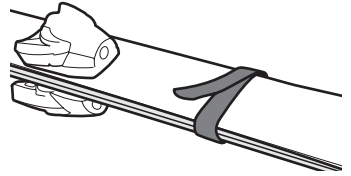
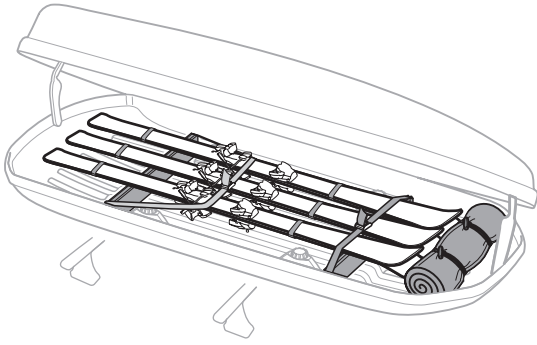
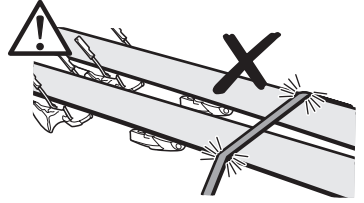
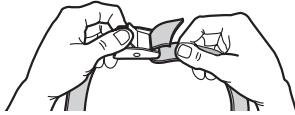

7

a

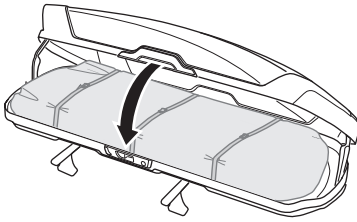

b

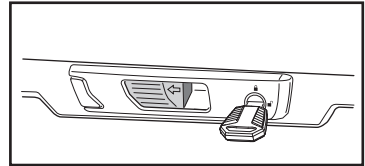
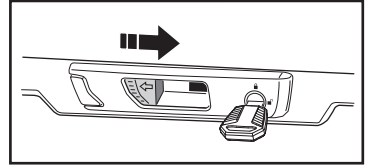
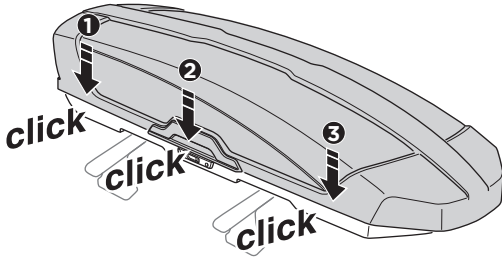

c

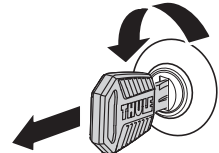
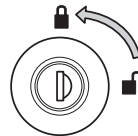
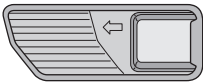
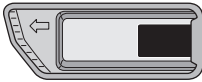

8

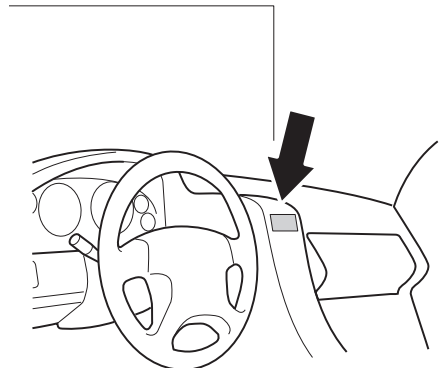
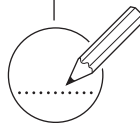
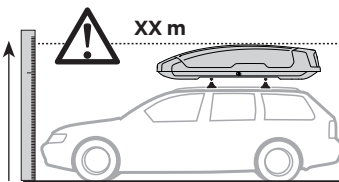
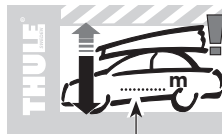

Thule T-track Adapter

696600 → 24x30 mm

697600 → 20x27 mm

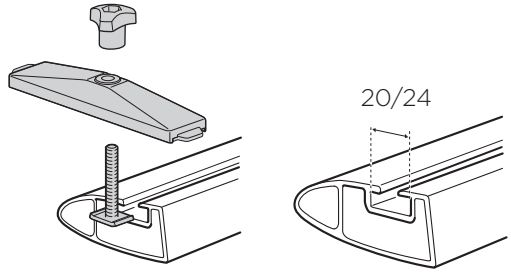

Thule MultiLift

572004

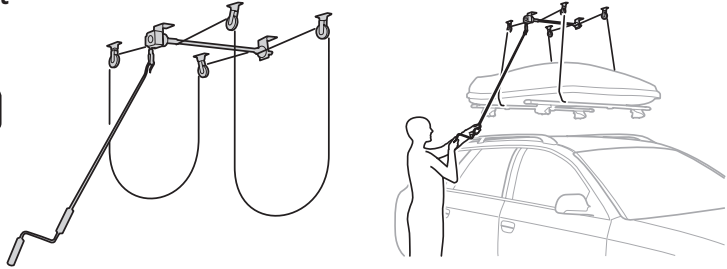

Thule Box Ski Carrier Adapter

694600 → Sport

694800 → M/L

694900 → XL/XXL/Alpine

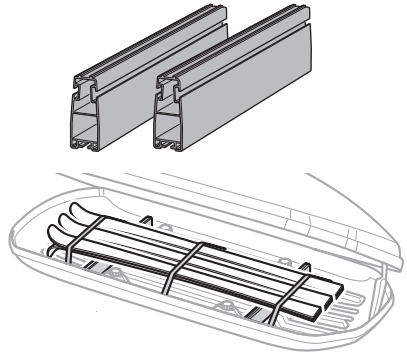

Thule Box Lid Cover

698100 → S/M/L

698200 → Sport



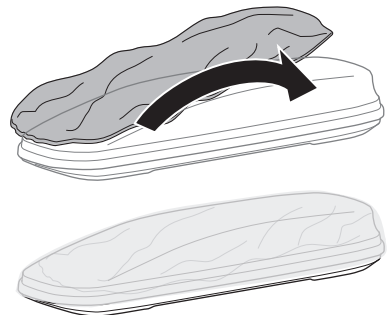

698400 → XL/XXL/Alpine

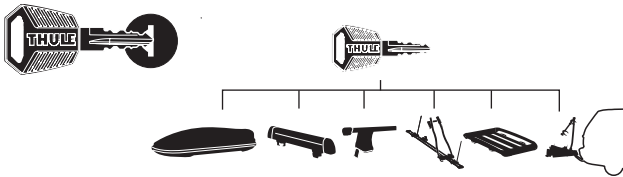

EN Accessories	DK Tilbehør	UK Аксессуары	EL Εξαρτήματα
DE Zubehör	NE Tilbehør	BG Принадлежности	TR Aksesuarlar
FR Accessoires	FI Lisävarusteet	CS Doplòky	AR الملحقات
NL Accessoires	ET Lisavarustus	SK Príslušenstvo	HE אביזרים
IT Accessori	LV Piederumi	SL Dodatki	ZH 附件
ES Accesorios	LT Priedai	HR/BiH Dodaci	JA アクセサリー
PT Acessórios	PL Akcesoria	RO Accesorii	KO 액세서리
SV Tillbehör	RU Аксессуары	HU Tartozékok	TH อุปกรณ์เสริม

Thule One-Key System



- 450400**  (x4)
- 450600**  (x6)
- 450800**  (x8)
- 451200**  (x12)
- 451600**  (x16)

