



## Thule XT Kit 3029

# > Instructions

**MERCEDES Viano**, 5-dr MPV, 04-14

**MERCEDES Vito**, 4-dr VAN, 04-14, 15-

**MERCEDES V-Class**, 5-dr MPV, 15-

This kit is only for vehicles with fixpoint mounting.

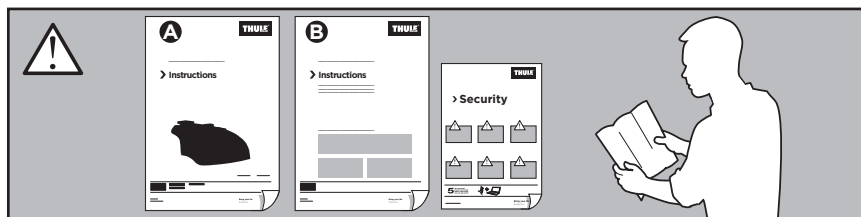

	+			<b>6 kg</b> <b>13 lbs</b>	=	<b>Max.</b> <b>100 kg / 220 lbs</b>
	+			<b>9 kg</b> <b>20 lbs</b>	=	<b>Max.</b> <b>150 kg / 330 lbs</b>
	+			<b>12 kg</b> <b>26 lbs</b>	=	<b>Max.</b> <b>200 kg / 440 lbs</b>

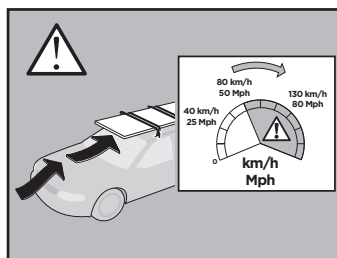

ISO 11154-E

183029

C.20141223  
509-3029-03

Bring your life  
thule.com

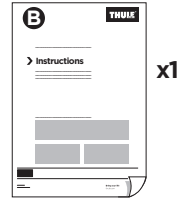
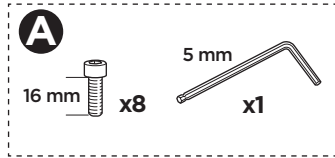
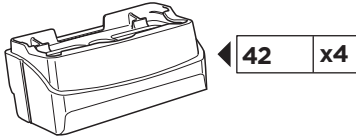
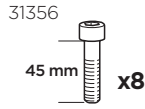
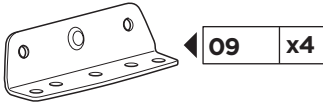

1

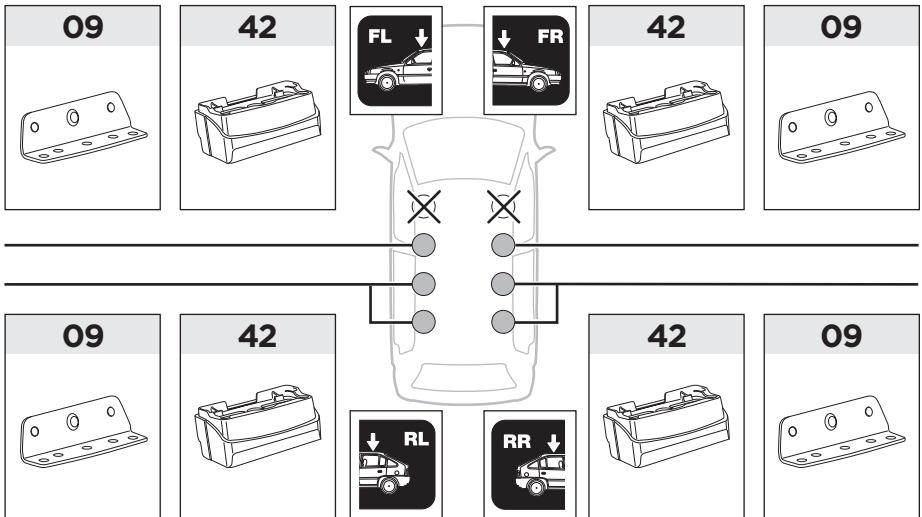

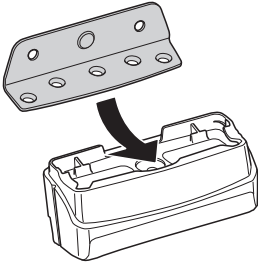
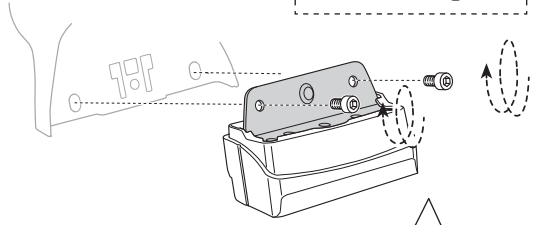
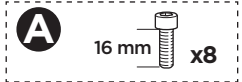
**2****A****B**

**EN** Only a few turns  
**DE** Nur wenige Umdrehungen  
**FR** Quelques tours uniquement  
**NL** Slechts enkele slagen  
**IT** Solo qualche giro  
**ES** Sólo algunas vueltas  
**PT** Noções básicas  
**SV** Endast några varv  
**DK** Kun nogle få omgange  
**NE** Bare noen få omdreinger  
**FI** Vain muutama kierros  
**ET** Ainult mõni pööre  
**LV** Tikai dažī apgriezieni  
**LT** Tik keli pasukimai  
**PL** Wystarczy kilka obrotów  
**RU** Только несколько оборотов

**UK** Лише декілька обертів  
**BG** Само няколко завъртания  
**CS** Pouze několik otáček  
**SK** Len niekoľko otáčok  
**SL** Le nekaj obratov  
**HR/BIH** Samo nekoliko okreta  
**RO** Doar câteva rotiri  
**HU** Csak néhány fordítás  
**EL** Μόνο λίγες περιστροφές  
**TR** Yalnızca birkaç tur

بعض دورات فقط

**AR**

רק מספר סיבובים

**HE**

**ZH** 仅几圈  
**JA** 2～3回転のみ  
**KO** 몇 번만 돌리면 됨  
**TH** เพียงสองสามรอบ

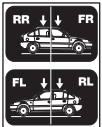
**3**

x1

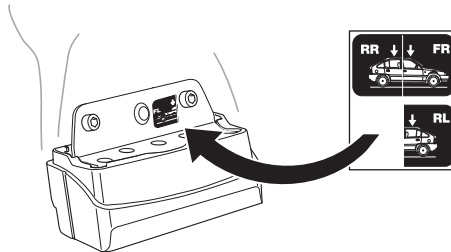

**4**

45 mm x8  x8  x8

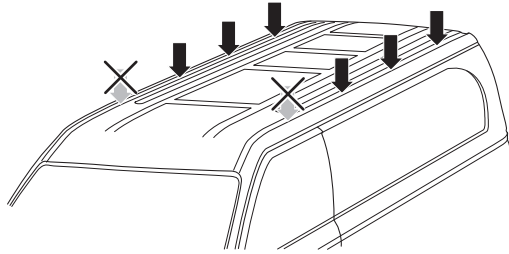
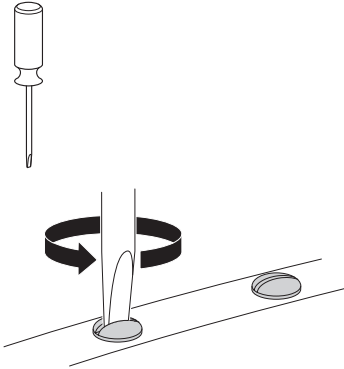
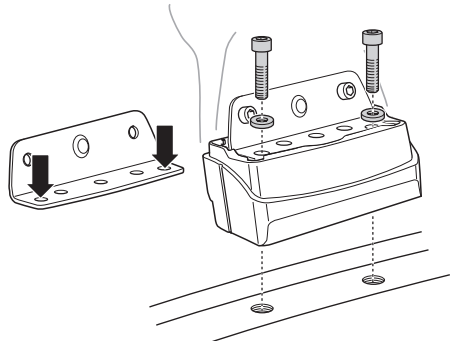
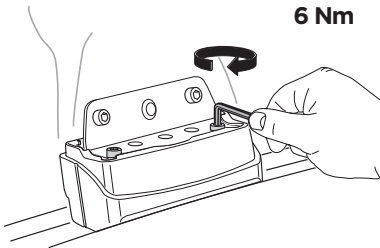
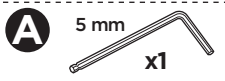
**A****B****5****A****B**