

Thule Rapid System Kit 1694

> Instructions

HYUNDAI i40, 4-dr Sedan, 11-

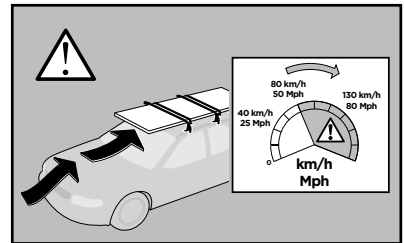
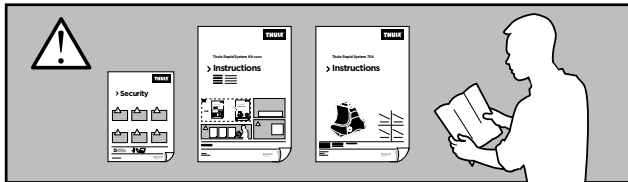
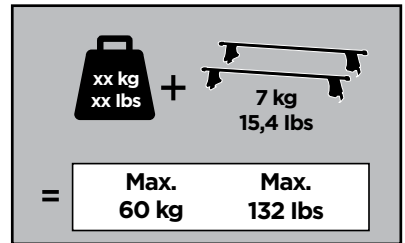
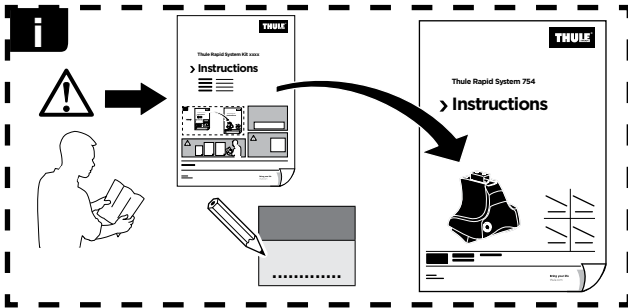

ISO 11154-E

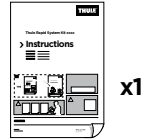
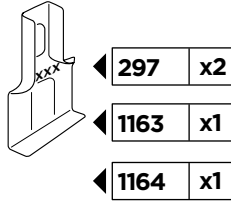
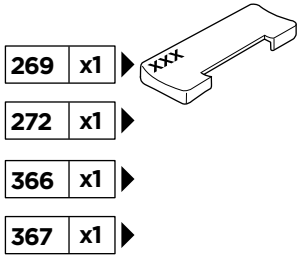

1

	X (scale)	X (mm)	X (inch)
HYUNDAI i40 , 4-dr Sedan, 11-	43,5	1086	42 3/4

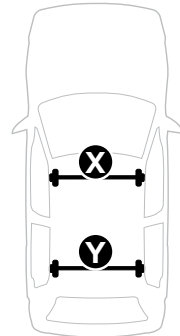
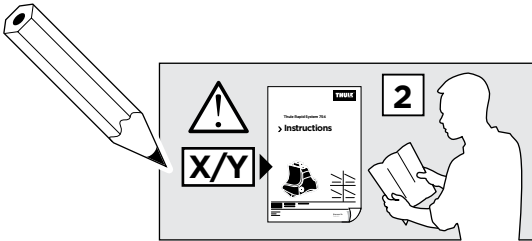

	Y (scale)	Y (mm)	Y (inch)
HYUNDAI i40 , 4-dr Sedan, 11-	41,5	1066	42

2

HYUNDAI i40, 4-dr Sedan, 11-

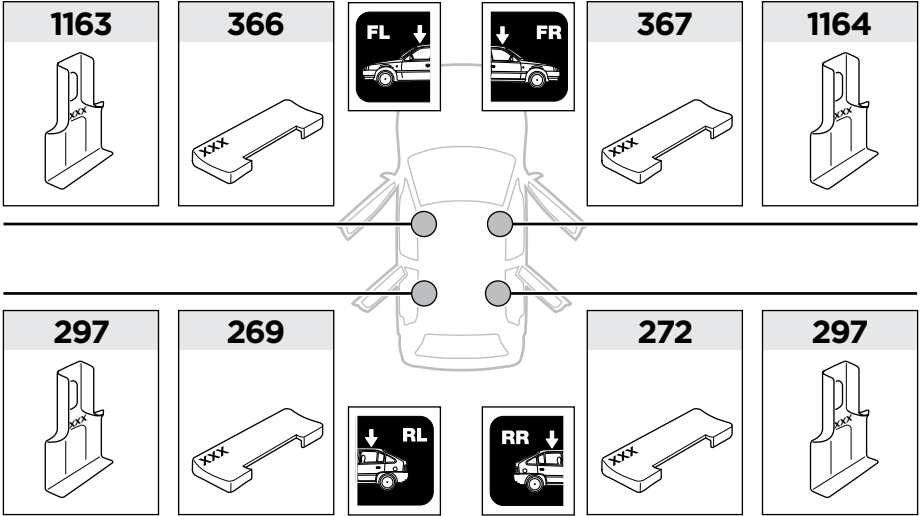

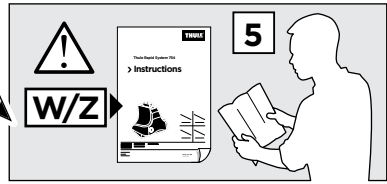
3

	W (mm)	Z (mm)	W (inch)	Z (inch)
HYUNDAI i40, 4-dr Sedan, 11-	350	700	13 ³/₄	27 ¹/₂

