

# ➤ Instructions

## Thule FreeRide 532

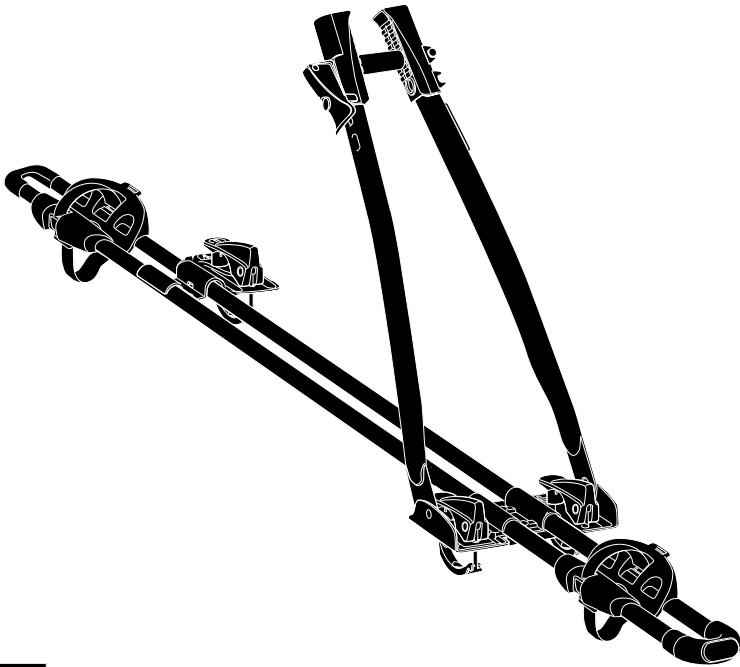



**i**

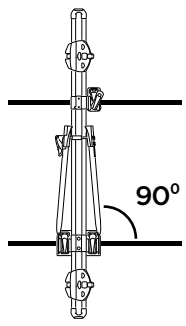
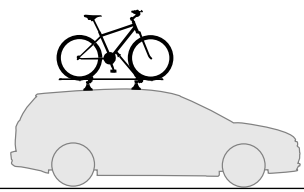
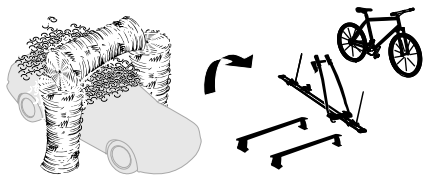
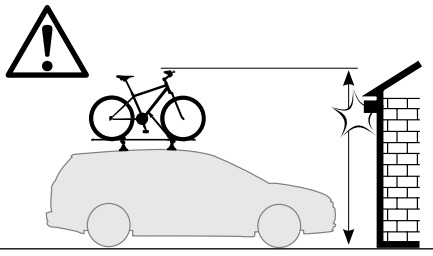
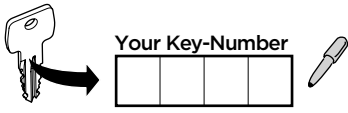

3.5 kg



= Max 17 kg

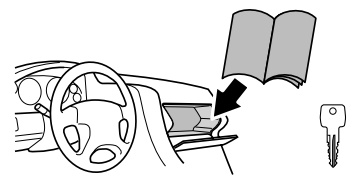

1

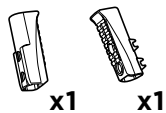
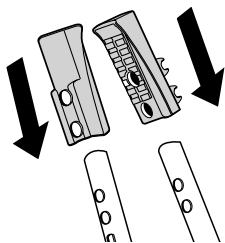

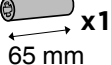
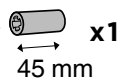

2

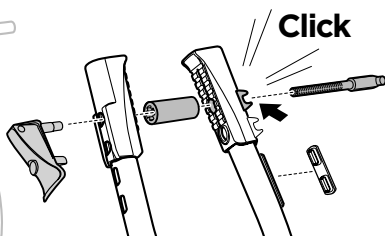
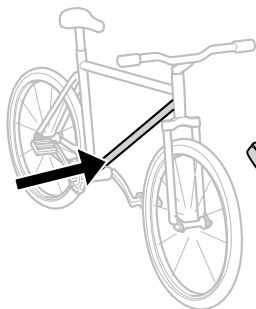

  $\varnothing 22 - 58 \text{ mm}$



  $\varnothing 59 - 70 \text{ mm}$   
  $\text{Max } 65 \times 80 \text{ mm}$

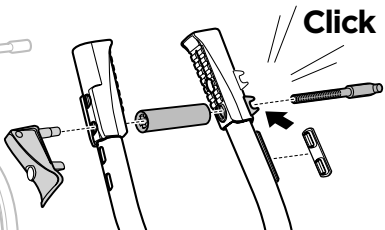
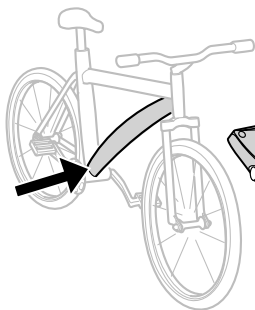

**3**

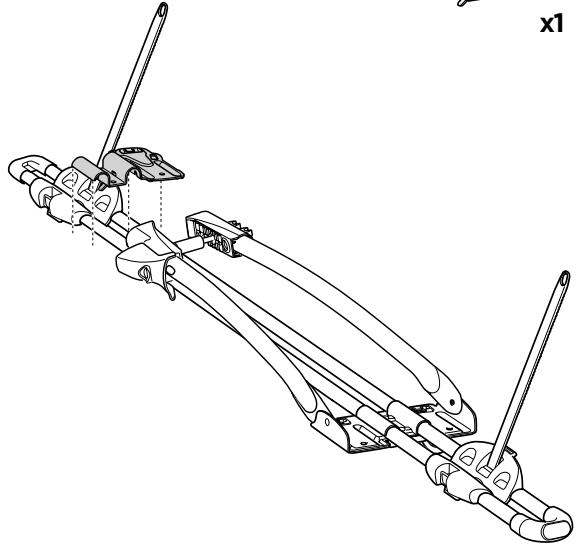
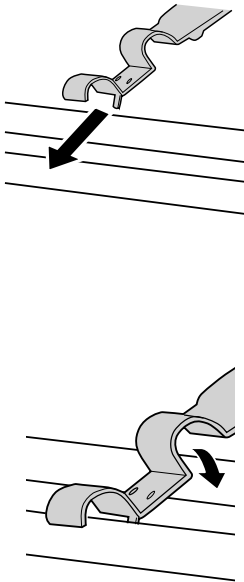

**4**

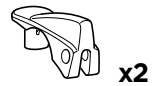
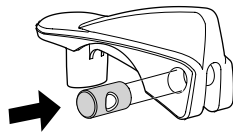
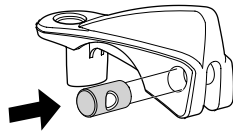

5

**i**

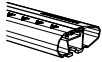

Thule WingBar Evo

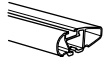

Thule WingBar



x1



x3

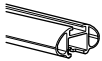

Thule AeroBar



Thule SlideBar



x2

**A**

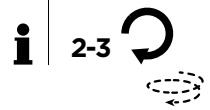
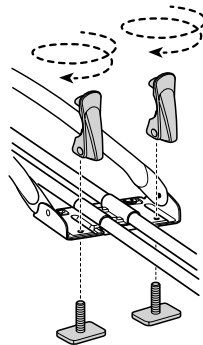
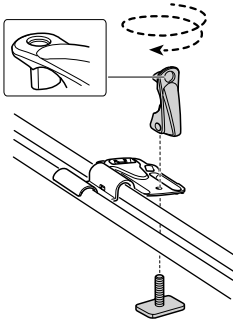

**B**

**i**



THULE WingBar Evo

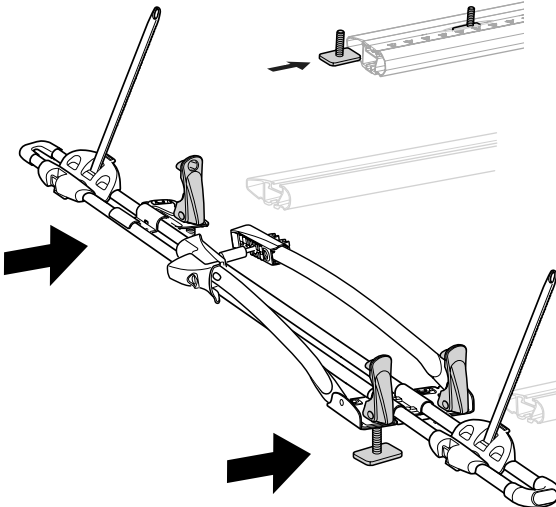
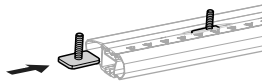

**C**

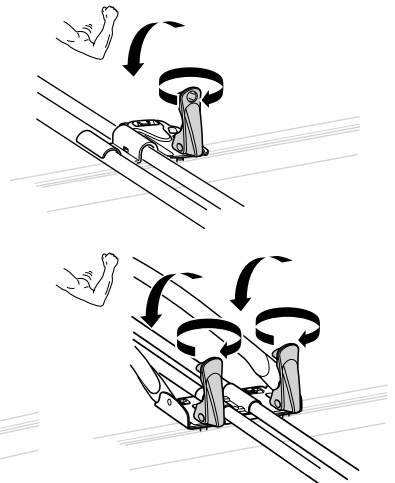

5

i



Thule SquareBar



x1



x3



x2



x3

A

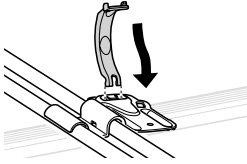

B

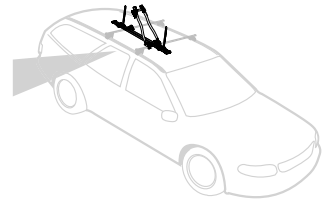
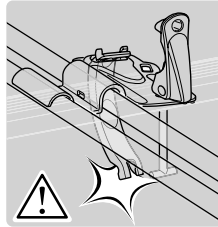
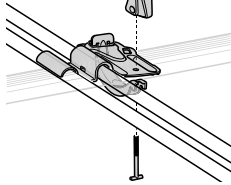
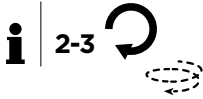

C

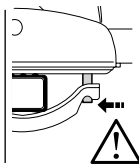
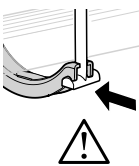

D

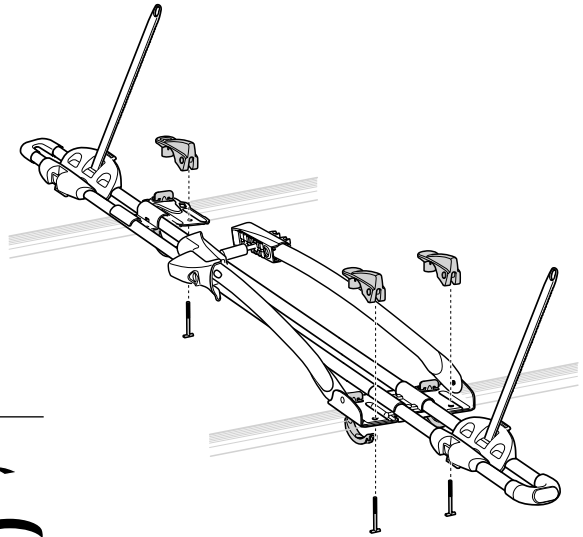
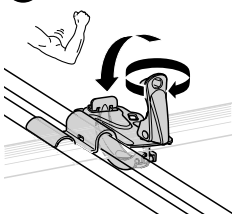

6

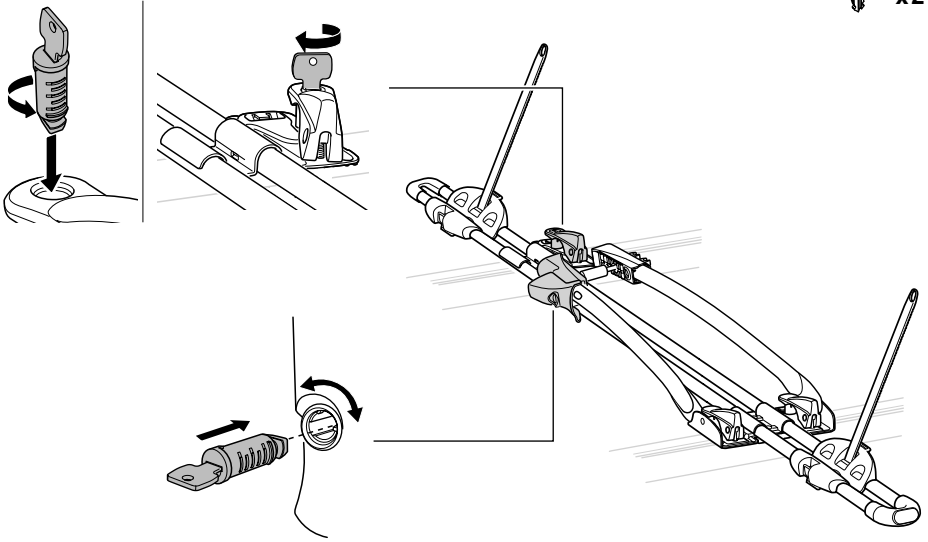

7

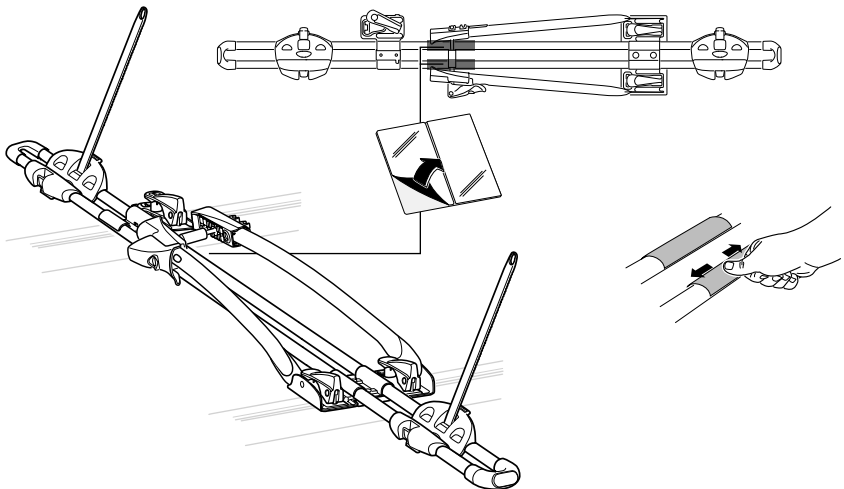
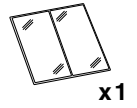



8

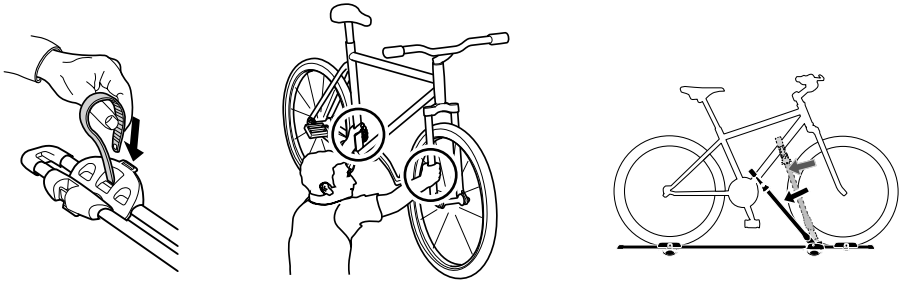

9

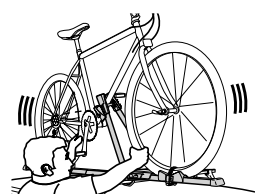
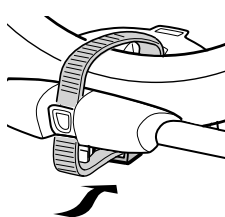
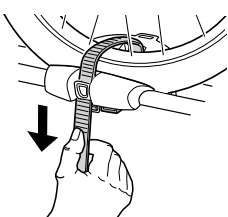
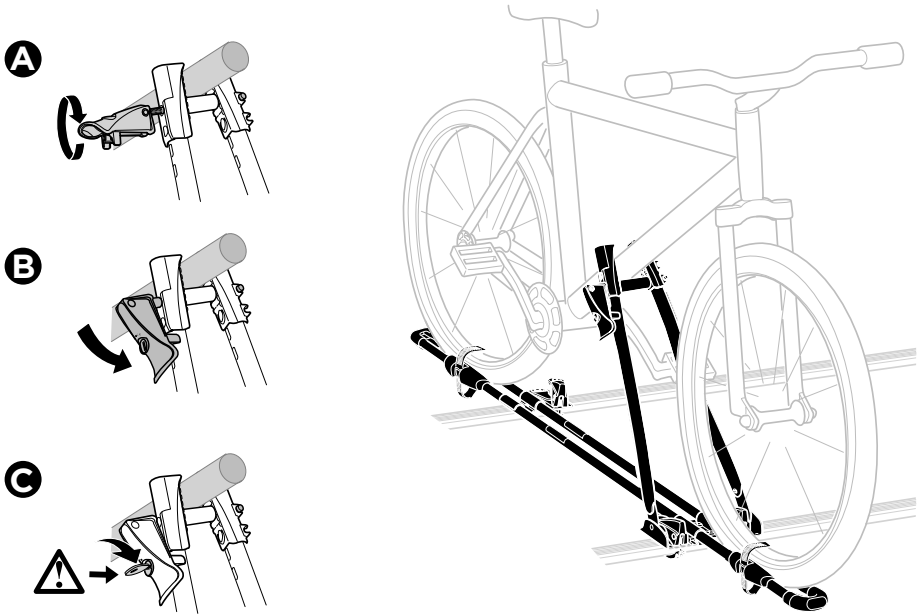

**EN** Left-hand fitting  
**FR** Montage côté gauche  
**ES** Montaje a izquierda  
**DE** Montage links  
**NL** Montage aan de linker kant  
**PT** Montagem do lado esquerdo  
**IT** Montaggio a sinistra  
**SV** Vänstermonterad  
**DK** Venstremontering  
**NO** Venstremontering  
**FI** Asennus vasemmalle  
**IS** Festing vinstra megin  
**ET** Vasakpoolne kinnitamine  
**LV** Kreisais stiprinājums  
**LT** Kairysis pritvirtinimas  
**RU** Установка на левую сторону  
**UK** Установка на ліву сторону  
**PL** Montaż z lewej

**CS** Montáž z levé strany  
**HU** Bal oldalról szerelhető  
**RO** Montare pe partea stângă  
**SK** Montáž na ľavej strane  
**SL** Pritrjevanje z leve strani  
**BG** Монтаж отляво  
**HR** Montaža s lijeve strane  
**EL** Τοποθέτηση αριστερά  
**TR** Sol elle montaj  
**MT** Pemasangan kidal

**HE** התקנה שמאלית  
**AR** التركيب في الجانب الأيسر

**ZH (CN)** 从左侧安装  
**ZH (TW)** 左側安裝  
**JA** 左手装着  
**KO** 왼손 장착  
**TH** ตัวยึดด้านซ้ายมือ  
**MS** Twañhil bl-id ix-xellugija

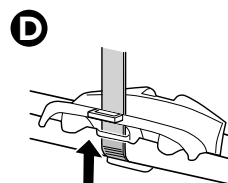
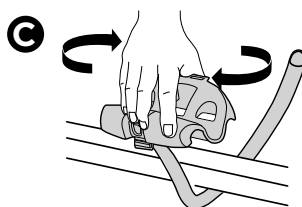
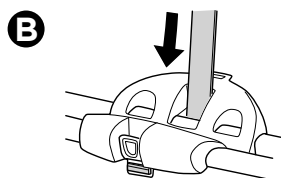
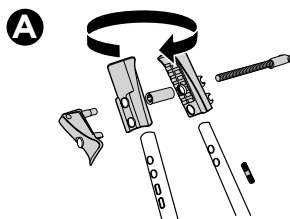
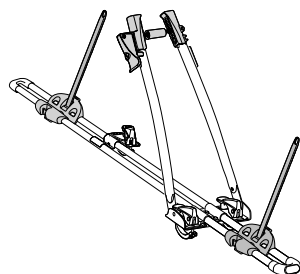

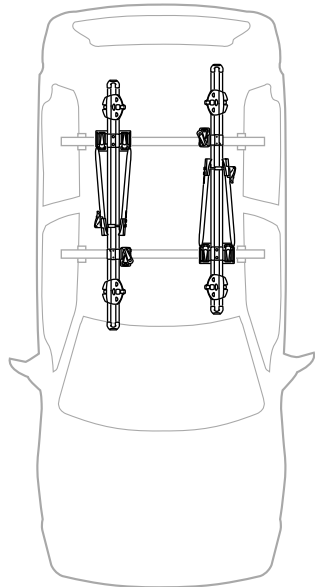
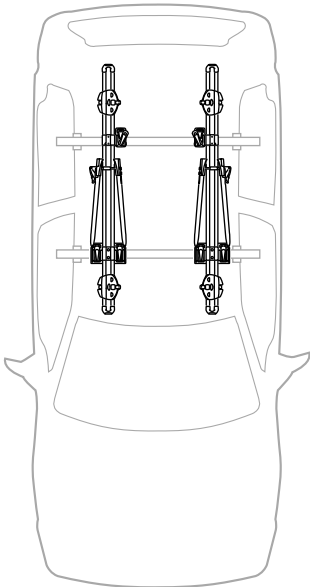
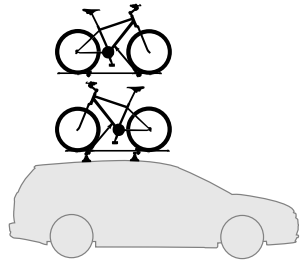
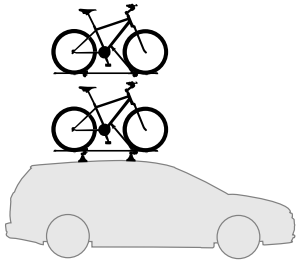

EN Accessories  
 FR Accessoires  
 ES Accesorios  
 DE Zubehör  
 NL Accessoires  
 PT Acessórios  
 IT Accessori  
 SV Tillbehör  
 DK Tilbehør

NO Tilbehør  
 FI Lisävarusteet  
 IS Aukabúnaður  
 ET Lisavarustus  
 LV Piederumi  
 LT Priedai  
 RU Аксессуары  
 UK Аксесуары  
 PL Akcesoria

CS Doplòky  
 HU Tartozékok  
 RO Accesorii  
 SK Príslušenstvo  
 SL Dodatki  
 BG Принадлежности  
 HR Dodaci  
 EL Εξαρτήματα  
 TR Aksesuarlar

MT Aċċessorji  
 HE אביזרים  
 AR ملحقات  
 ZH (CN) 附件  
 ZH (TW) 配件  
 JA アクセサリー  
 KO 액세서리  
 TH อุปกรณ์เสริม  
 MS Aksesori

## Thule One-Key System

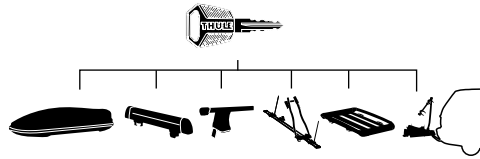

**450400**  (x4)

**450600**  (x6)

**450800**  (x8)

**451200**  (x12)

**451600**  (x16)

## Thule Adapter 889-3

