

Installation Manual

BMW X4 5DR
BMW-X4-5-A



COMPONENTS INCLUDED

SHADES

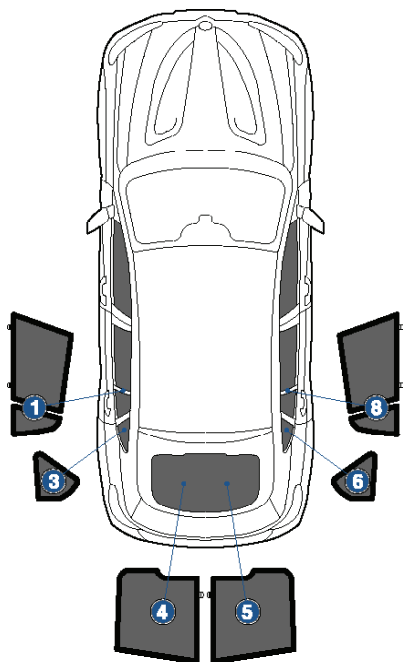

FIXING CLIPS



CL-M12 x 2



CL-M04 x 6



CL-M13 x 4



CL-M14 x 1

Side Shade (A) Installation

BMW X4 5DR
BMW-X4-5-A

COMPONENTS NEEDED:

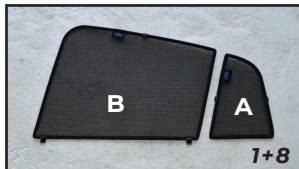

STEP #1

ATTACH CLIPS ON SHADE EDGES



STEP #2

POSITION THE SIDE SHADE



STEP #3

INSERT CLIPS BEHIND INTERIOR TRIM



STEP #4

ENSURE SECURELY FITTED IN PLACE



CAR
SHADES

Side Shade (B) Installation

BMW X4 5DR

BMW-X4-5-A

COMPONENTS NEEDED:

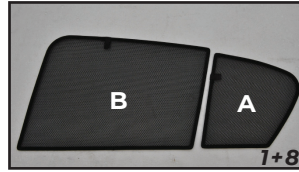

CL-M04 x1



CL-M13 x2

STEP #1

ATTACH CLIPS ON SHADE EDGES



STEP #2

POSITION THE SIDE SHADE

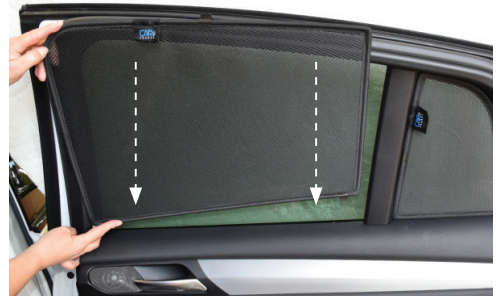

STEP #3

INSERT CLIPS BEHIND INTERIOR TRIM



STEP #4

ENSURE SECURELY FITTED IN PLACE

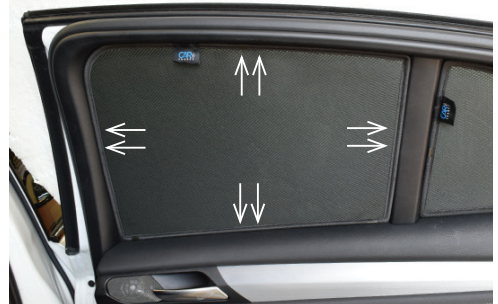

CAR
SHADES

Quarter Light Shade Installation

BMW X4 5DR
BMW-X4-5-A

COMPONENTS NEEDED:



STEP #1

ENSURE SECURELY FITTED IN PLACE

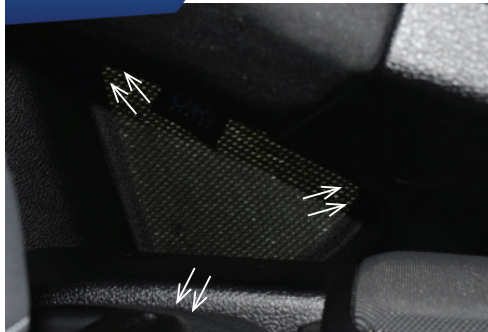

CAR
SHADES

Rear Shade Installation

BMW X4 5DR
BMW-X4-5-A

COMPONENTS NEEDED:



STEP #1

ATTACH CLIPS ON SHADE EDGES



STEP #2

POSITION THE REAR SHADE

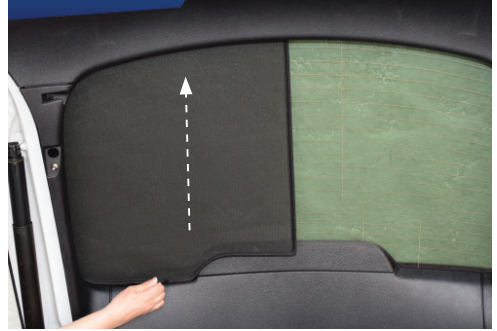

STEP #3

INSERT CLIPS BEHIND INTERIOR TRIM



STEP #4

REPEAT THE PROCESS ON OTHER SHADE



STEP #5

ENSURE SECURELY FITTED IN PLACE



CAR
SHADES