

# Installation Manual

TOYOTA CH-R 5DR

TOY-CHR-5-A



## COMPONENTS INCLUDED

## SHADES

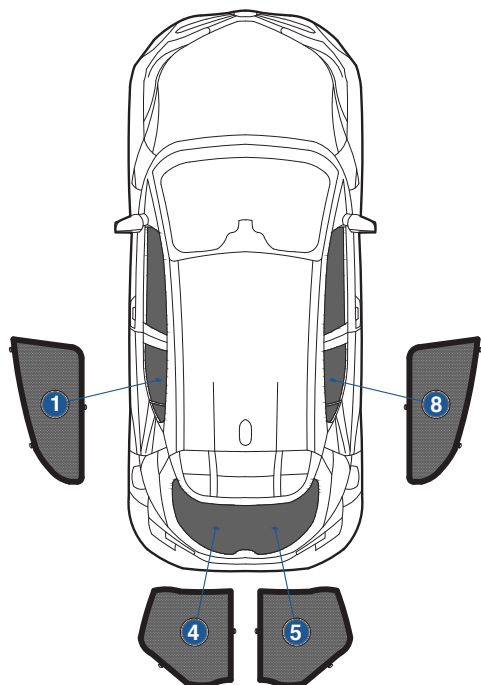

**CAR**  
SHADES

## FIXING CLIPS



CL-M02 x 04



CL-M04 x 2



CL-M12 x 4



CL-M13 x 2



CL-M14 x 1

# Side Shade Installation

TOYOTA CH-R 5DR  
TOY-CHR-5-A

## COMPONENTS NEEDED:



### STEP #1

ATTACH CLIPS ON SHADE EDGES



### STEP #2

POSITION THE SIDE SHADE



### STEP #3

INSERT CLIPS INSIDE WEATHERSTRIP

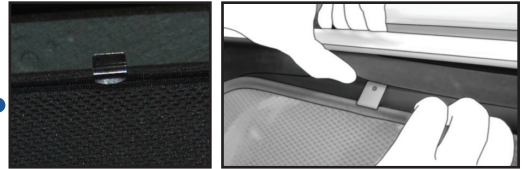

### STEP #4

ENSURE SECURELY FITTED IN PLACE

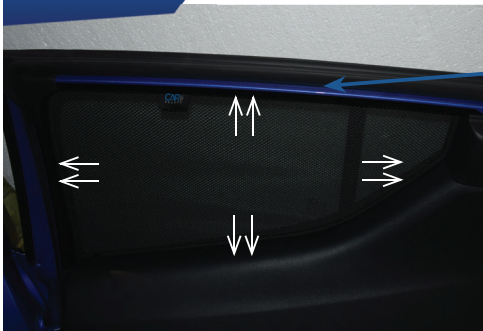

**CAR**<sup>®</sup>  
SHADES

# Rear Shade Installation

TOYOTA CH-R 5DR  
TOY-CHR-5-A

## COMPONENTS NEEDED:

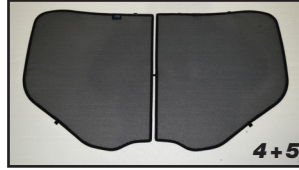

### STEP #1 ATTACH CLIPS ON SHADE EDGES

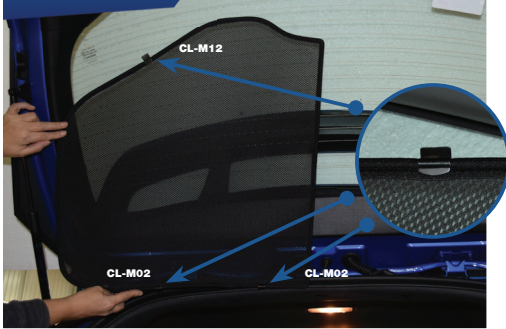

### STEP #2 POSITION THE REAR SHADE

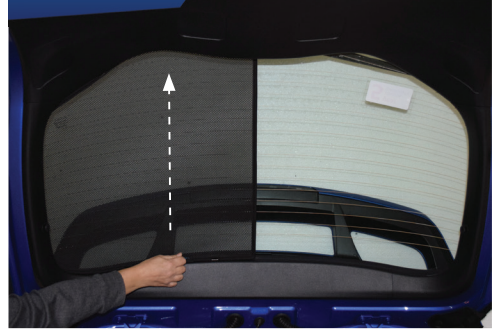

### STEP #3 INSERT CLIPS BEHIND INTERIOR TRIM

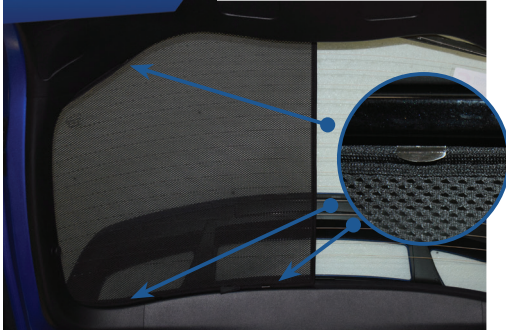

### STEP #4 REPEAT THE PROCESS ON OTHER SHADE

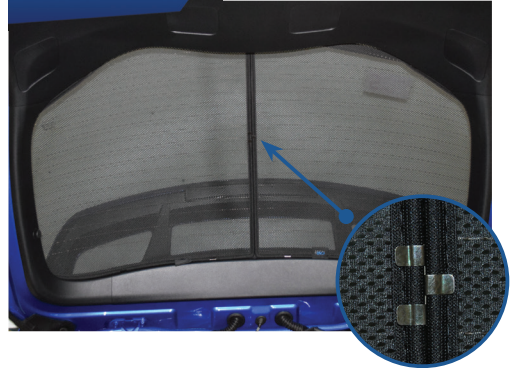

### STEP #5 ENSURE SECURELY FITTED IN PLACE

